

ISSN[ONLINE]:2643-9875 ISSN[PRINT]:2643-9840

IJMRA

**International Journal of
Multidisciplinary Research and
Analysis**

**VOLUME 07 YEAR 2024
ISSUE 11 NOVEMBER**

**SJIF IMPACT
FACTOR:
8.22**

**IJMRA ASI
SCORE:
1.3**

**CROSSREF
DOI:
10.47191/IJMRA**

**International Journal of Multidisciplinary
Research and Analysis is a leading analysis
journal for publication of new ideas in
multidisciplinary area**



EXPLORE YOUR RESEARCH TO THE WORLD....

[www.https://ijmra.in/](https://ijmra.in/)

Email: editor@ijmra.in

Editorial Team Member

Dr. V. Mohana Sundaram (Ph.D. (Management))

Professor, Department of Management Studies, Vivekanandha Institute of Information and Management Studies.

Dr. Murod Barakaev(Candidate of Pedagogical Sciences(13.00.02 - Methods of teaching mathematics))

Associate Professor of "Mathematics and Methods of Teaching" TSPU named after Nizami

Uzbekistan

Karimov Nodir Rakhmonqulovich (Pursuing Ph. D.)

Ph.D. Student, Tashkent State University of Oriental Studies, Tashkent, Uzbekistan

Tashkent, Uzbekistan

Anshika Bansal (N.E.T,U-SET)

Asst. Professor Department of Commerce,

Govt P.G. College, Kotdwara, Uttarakhand, **INDIA**

Dr. Dinh Tran Ngoc Huy (MBA (Finance and Management electives))

PhD candidate, Banking University, HCM city

Cach Mang Thang Tam Street, Ward 11, Dist 3, Ho Chi Minh City, Viet Nam

Dr. Islam-ul-Haque (MBA (24 project management subjects- AIOU))

PhD Environmental Engineering and sciences

House No. 12, Al-Ghani Street, IFCOS, Sector D-17, Islamabad

Dr. Alisher Doniyorov (Doctor of Sciences in Historical Sciences)

Professor-Tashkent State University of Oriental studies,Tashkent, **Uzbekistan**

Tashkent, Uzbekistan

Manish Soni (Ph.D in Computer Science and Application)

Assistant Professor, Department of Computer Science, Govt. P.G College

Mandsaur, India

Dr Bakhodir K. Mirzaev (Doctor of Philosophy in Technical Sciences)

Senior Lecturer, Department of "Manufacture of building materials, products and structures" Fergana Polytechnic Institute

Fergana Region, Kushtepa District

Dr Abdulkhamid R. Yusupov (Technical Sciences)

Associate Professor of the Department of Production of Building Materials, Products and Structures of Fergana Polytechnic Institute

Fergana City, Behbudi Street

Dr Nodira B. Alimova (Doctor of Technical Sciences)

Associate Professor of the Department of "Mechatronics and Robotics", Tashkent State Technical University

Tashkent City, Mirzo Ulugbek

Dr Kuysin D. Tukhtaeva (Doctor of Philological Sciences)

Navoi State Pedagogical Institute, Faculty of Foreign Languages, Associate Professor of English Language and Literature, Candidate of Philological Sciences

Navoi Region, Navoi City

Dr.Umesh Sehgal(Ph.D. (Computer Science))

Assistant Professor and Department Head (GNA University, Phagwara),Bundelkhand University, Jhansi
India

Dr. Grebenisan Gavril (Ph.D. Eng)

Assoc. Prof. University of Oradea, 1 Universitatii str., 410089, Oradea, **Romania**

Professor Ibrahim Ormanovich Darvishov (Doctor of Philosophy in Philology, (PhD))

Acting Associate Professor of Uzbek Language and Literature, Namangan State University
Namangan Region, Mingbulak District

Professor Abdulvohid Khabibullevich Abdullazizov

Acting Head of the Department of Russian Language and Literature, Namangan State University
Namangan Region, Uychi District

Dr. Bogdan Constantin Ungurean (PhD Biology)

Lector, Faculty of Physical Education and Sport of "Al. I. Cuza" University
Str. Toma Cozma Nr. 3, Iasi 700554, **Romania**

Dr Kadir Shukurlaev (DCs)

Head of the Department of Physiology and Pathological Physiology, Urgench branch of the Tashkent Medical Academy
Republic Of Karakalpakstan, Amudarya District

Dr Bakhromjon A. Otakulov (Doctor of Philosophy in Technical Sciences)

Senior Lecturer of the department "Manufacture of building materials, products and structures" Fergana Polytechnic Institute
Fergana Region, **Fergana District**

Dr. Abdirashid M. Babadjanov (Candidate of Economic Sciences)

Associate Professor of the Department "Accounting and audit" of the Tashkent Institute of irrigation and agricultural engineers.
Tashkent City, Sergeli District

Professor Karimkhodjaev Nazirjon,

Associate Professor of the Andijan Machine-Building Institute. Department of "Avtomotive"
Uzbekistan

Dr. P.Ganesh Kumar (Doctorate(PhD))

Professor in Networking, K.L.N College of Engineering, Anna University
Anna University, Chennai, **Tamil Nadu, India, 2009**

Dr Durdana E. Lutfullayeva (Doctor of Philological Sciences)

Leading Researcher of the Department of Modern Uzbek Language of the Institute of Uzbek Language, Literature and Folklore of
the Academy of Sciences
Tashkent City, Shayhontohur District

Dr. Rano Kh. Davlatova(Doctor of Philological Sciences)

Head of the Department of Preschool Education, Navoi State Pedagogical Institute
Navoi City, Lomonosova Street

Dr. Gulmira K. Obidova(Ph.D. in Pedagogical Sciences)

Assistant of the Department of Languages and Sports, Fergana Branch,Tashkent University of Information Technologies
Fergana Region, Fergana City

Dr. Md. Amir Hossain (PhD)

Assistant Professor, Department of English IBAIS University (International Business Administration and Information System)
Bangladesh

Dr. Parizod Sh. Turopova(Doctor of Philosophy in Philology)

Senior Lecturer of the department of teaching methods of Uzbek literature of Jizzakh State Pedagogical Institute
Jizzakh City, Uratpalik Mahalla

Dr. Nodira I. Soatova (Philological Sciences)

Associate Professor of the Department of Methods of Teaching Uzbek Literature at Jizzakh State Pedagogical Institute
Sh.Rashidov District, Uzbekistan

Tahir, Nura Musa (B. Eng. (BUK), M Eng. (UTM, Malaysia).)

Department of Mechatronics and System Engineering, Faculty of Engineering and Engineering Technology, Abubakar Tafawa Balewa University, Bauchi,
P.M.B 0248, Bauchi, Bauchi State, Nigeria

Dr. Saida I. Sadiqova(PhD)

Associate Professor of the Department of Internal Medicine No. 2 of the Tashkent Medical Academy
Namangan City, Namangan Region

Dr. Manoj Kumar Rastogi (Ph.D. (Statistics))

Assistant Professor Department of Statistics Patna University,
Department Of Statistics, Patna University, Patna-05, **Bihar**

Dr. Mourad Hebali (Ph.D. in Electrical Engineering)

Professor Assistant in University Mustapha STAMBOULI Mascara
Mascara 29000, **Algeria.**

Dr. Shaimardan K. Hudjanov (Candidate of Medical Sciences)

Associate Professor of ENT Diseases, Tashkent Medical Academy
Tashkent Region, Zangiota District

Dr. Devarani Devi Ningombam (Ph. D.Computer Engineering)

Post-doctoral fellow, Department of Information strategy, Electronics and Telecommunications Research Institute (ETRI)
Electronics And Telecommunications Research Institute (ETRI) Dormitory, Gajeong-Dong, Yuseong-Gu, Daejeon 34129, South
Korea

Dr. Shakhnoza Mukhamedjanovna Jalolova (Doctor of Philosophy in Philology)

Acting Associate Professor of English Philology, National University of Uzbekistan named after Mirzo Ulugbek
Tashkent City, Chilanzar District, Kyzyl Sharq District, **Uzbekistan**

Dr. Suheela Shabir (Doctorate (PhD) in Marketing)

Asst. Prof. in College of Business and Administration in PRINCESS NOURA BINT ABDUL RAHMAN UNIVERSITY, Riyadh
Saudi Arabia

Dr. Abdilatip Abdirakhimovich Sarimsokov (Historical Sciences)

Acting Head of the Department of Archeology, Namangan State University
Namangan City, Porloq MCM, 3rd Micro-District, 3rd House, 8th Apartment

Dr. Dharmendra Singh (PhD, CFP, CFA, Associate-life, UGC-NET)

Assistant Professor, Modern College of Business and Science (MCBS), Sultanate of Oman
Oman

Dr. Ayman Shehata Mohammed Ahmed Osman Mohammed El-Shazly (Ph.D. (Pure Mathematics- Mathematical Analysis - Complex Analysis))

Lecturer, Department of Mathematics, Faculty of Science, Assiut University, Assiut 71516,
Egypt

Dr. Jamila Sharipovna Jumabayeva (Doctor of Philological Sciences)

Head of the Department of English Philology, Faculty of Foreign Philology, National University of Uzbekistan named after Mirzo
Ulugbek Tashkent

Dr. Lola S. Ortikova (Doctor of Philosophy in Agricultural Sciences)

Lecturer of the Department of Biology Teaching Methods, Jizzakh State Pedagogical Institute
Jizzakh City, Almazar Mahalla,

Farisa T S(M.Tech (CSE))

Digital signal processing, Data Mining, Natural Language Processing **INDIA**

Dr. G.RakeshP.hd(Computer Science & Application)

Dean of Science JAIRAMS COLLEGE OF ARTS & SCIENCE, KARUR.**INDIA**

Dr. Shamsiddin A. Allayarov(Ph.D.)(Candidate of Economic Sciences)

Head of the Department of Management and Marketing, Tashkent Financial Institute
Tashkent City, Mirzo Ulugbek District

Dr. Rashmi Rai(Ph. D,(Quality of Work-Life and Job Performance))

Assistant Professor , Management Department , Christ University, **Bangalore,INDIA**

Dr. Ravshan Khudayberganov(PhD on historical sciences)

Senior scientific researcher, Al-Beruni Institute of Oriental Studies, Academy of Sciences of the Republic of Uzbekistan, Tashkent,
Tashkent, Uzbekistan

Dr. Mohammed Nader Shalaby(Ph.D. Degree of Pathobiology and Physiology)

Associate Prof. of Biological Sciences and Sports Health Department, Faculty of Physical Education, Suez Canal University
Egypt, Ismailia

Dr.Mona Mostafa Abdo Sakoury(P.hd)

Associate Professor, Faculty of Applied Studies and Community, Service, Imam Abdulrahman Bin Al- Faisal University.
Saudi Arabia

Dr. Rita Greengold(Ph. D, Histroy)

College of William & MaryLyon G. Tyler Department of History.

Dr. Nargiza Sharopaliyeva Mullaboeva(Doctor of Philosophy in Psychology (PhD))

Senior Lecturer of Namangan Institute of Engineering and Technology, **Uzbekistan**

Dr. Shuchi Gupta(PhD (Commerce))

Associate Professor,University of Hail, KSA
Haryana, India

Dr. P.Malyadri(Ph.D. (Bank Finance for Rural Development))

Principal for 11 Years in Government Degree Colleges,Srisailam,Patancheru, Tandur,Chevella,Serilingampally,Kukatpally
Hyderabad, INDIA

Dr. Makhmud Akhmedovich Shakhodjaev

Associate Professor of Fergana Polytechnic Institute, Faculty of Energy, "EEE"
Fergana Region, Margilan City, M.Khofiz Street

Dr. Xaynazarov Baxromjon (Phd In History)

Faculty of History,National University of Uzbekistan
Tashkent, Uzbekistan

Dr. Dildora Bakhadirjanovna Agzamova

Associate Professor of "Translation Theory and Comparative Linguistics" of the National University of Uzbekistan named after
Mirzo Ulugbek

Dr. Izzatilla Makhmutalievich Khaydarov

Associate Professor of "History and Ethnology of the Peoples of Central Asia" Tashkent State University of Oriental Studies

Dr. Khurshida Erkinovna Yunusova(Doctor of Historical Sciences)

Professor of the Department of History of Uzbekistan, National University of Uzbekistan named after Mirzo Ulugbek
Tashkent City, Chilanazar District , Uzbekistan

Dr. Ravshan Berdimurodovich Siddikov(Doctor of Historical Sciences)

Associate Professor of History of Uzbekistan, National University of Uzbekistan named after Mirzo Ulugbek
Tashkent City, Almazar District, Uzbekistan

Dr. Ijod Narziqul ugli Akhmedov(Doctor of Philosophy (PhD) in Philosophy)

Head of the Department of Distance Education in Social Sciences and Humanities Jizzakh State Pedagogical Institute

Dr. Moise Adrian Cristian (Doctorate(PhD))

Associate Professor, Spiru Haret University of Bucharest, **Romania**

Dr. Umidjon Yandashalievich Kuziev

Acting Head of Department of Uzbek Language and Literature, Namangan State University
Namangan Region, Chust District

Akpojaro Oghenechuko Owens (Msc, PGD,HND, ND)

Assistant Lecturer, School of Basic Science Programme(Mathematics Unit), **Nigeria**

Dr. Prof. Shoeb Ahmad (Ph.D.)

PROFESSOR, Al Zahra College for Women, (Muscat) Oman
(Muscat) Oman

Rajibkumar Sanyal (M.Sc., PGDM, Ph.D., D.Sc. (Honoris Causa))

Associate Professor & Senior Researcher of Economics
Amity University, Kolkata Action Area II, Major Arterial Road, New Town

Dr. Askar R. Babaev

Acting Associate Professor
Tashkent City, Mirabad District,

Dr. Thirupathi Dongala(Ph.D, M.Sc. B.Sc. IT)

Working as Analytical Scientist-I with AUREX LABORATORIES LLC, 10 Lake drive, East Windsor, NJ, 08520 USA

Dr. Samuel Jacob Bunu (Doctor of Pharmacy)

Department of Pharmaceutical and Medicinal Chemistry, Faculty of Pharmacy, Niger Delta University, Wilberforce Island, Bayelsa State, **Nigeria.**

Chibuisi C. Okorieimoh Doctoral Researcher)

Assistant lecturer School of Multidisciplinary Technologies, Technological University Dublin

Dr. G.V.P. Samaranayake

Lecturer (Probationary), Department of Ayurveda Basic Principles, Gampaha Wickramarachchi Ayurveda Institute, University of Kelaniya, **Sri Lanka**

Khalid Zemam Amer

Responsible for the Division of Marketing of Scientific Products / Department of Scientific Affairs / Presidency of Mustansiriyah University

Dr. Wafaa Mohamed Mohamed Moustafa(M.Sc., B.Sc., Ph.D, chemical engineering)

Head of the Central Laboratory of Environmental Isotope Hydrology, **Egypt**

Dr. Chandramohan Andavar(Doctorate in Biochemistry. M.Sc., M.Tech)

Associate Professor and Head in the Department of Biochemistry Annai Violet College of Arts and Science Menambedu, Ambattur, Chennai, **India.**

Dr. Oyepata Simeon Joseph (Ph. D in Pharmacology and Toxicology)

Senior Lecturer, Department of Pharmacology, Faculty of Pharmaceutical Sciences, Bingham University, Karu, Nasarawa State, **Nigeria**

Dr. Janna A. Nazarova(Doctor of Medical Sciences)

Doctor of Medical Sciences

Tashkent City, Chilanzar District

Dr. Amadou Danlami(Ph. D in Commonwealth Literature and culture)

University of Dschang, Faculty of Arts, Letters and Social Sciences, Department of Applied Foreign Languages

Dr.Ramesh Prasad Adhikary(Ph.D)

Assistant Professor (English) Tribhuvan University, M.M. Campus, Nepalgunj

Dr Kholida K. Matjanova(Postgraduate, student of the Institute of Bioecology of the Karakalpak branch of the Uzbek Academy of Sciences)

Associate Professor

Republic Of Karakalpakstan, Amudarya District

Dr.Ali Adel Dawood(Ph.D,)

Lecturer, College of Medicine, Mosul, Iraq Course Unit Director, College of Medicine, Uni. of Mosul

IRAQ

Dr Raushana K. Kurbaniyazova(Doctor of Philosophy in Philosophy)

Senior Lecturer of the Department of Social Sciences, Urgench Branch of the 1st Tashkent State Medical Institute

Republic Of Karakalpakstan, Amudarya District

Dr. Kamila K. Juraeva (Ph.D.)

Associate Professor of Power Supply, Tashkent State Transport University

Tashkent

Dr. Wan Ainun Binti Mior Othman(Ph.D)

Associate Professor Institute of Mathematical Sciences, Faculty of Science, University of Malaya, 50603 Kuala Lumpur, **Malaysia.**

Dr. Dharmendra S. Mistry (Ph.D.)

Prin. M. C. Shah Commerce College (Navgujarat Campus),(Affiliated toGujarat University)

Ahmedabad, INDIA

Dr. Murodulla A. Juraev(Doctor of Philosophy in Philology)

Senior Lecturer of the Department of Methods of Teaching Uzbek Literature of Jizzakh State Pedagogical Institute

Jizzakh City, Ittifaq Mahalla

Dr. Surayyo I. Eshonkulova(Philological Sciences)

Associate Professor of Teaching Methods of Uzbek Literature, Jizzakh State Pedagogical Institute

Jizzakh Region, Jizzakh City

Dr. Namrata Raviraj Vaishamapayan(MD, PGDHA, BHMS)

Assistant Professor(Practice of Medicine),MNR Homoeopathic Medical College, Sangareddy, Telangana

Prof. Dr. Majid Mohammed Mahmood(Ph.D,)

A University professor of Immunology Mustansiriyyah University – College of Science, **Baghdad**

Dr. Yelibet K. Sultanov(Technical Sciences)

Associate Professor of "Agricultural Mechanization and Investment Activity" Nukus branch of Tashkent State Agrarian University.

Dr. Durdona A. Akhatova(Pedagogical Sciences)

Associate Professor of General Pedagogy and Psychology, Navoi State Pedagogical Institute

Professor Zulkhumor N. Tojjeva

Professor of Economic and Social Geography

Tashkent City, Yashnaabad District, Baku 1-Berk Street

Dr. Ulughbek M. Ergashev(PhD in Medical Sciences)

Senior Lecturer of the Department of Otorhinolaryngology and Dentistry, Tashkent Medical Academy

Tashkent City, Yashnabad District

Dr. Jamolbek A. Djuraev(Doctor of Philosophy in Medical Sciences)

Senior Lecturer, Department of Otolaryngology and Dentistry, Tashkent Medical Academy

Tashkent City, Almazar District

Dr. Lola S. Ortikova Senior Lecturer of the Department of Otolaryngology and Dentistry, Tashkent Medical Academy

Tashkent City, Mirabad District, Sadyk Azimov Street

Dr Ziyoda G. Mukhamedova(Doctor of Sciences in Technics)

Doctoral student of the Department of Freight Transport Systems, Tashkent State University of Transport (DSc)

Tashkent City, Yunusabad District

Dr. Shahzada Mudasir Rashid(PhD)

Assistant Professor (Scientist) Division of Veterinary Biochemistry, Faculty of Veterinary Sciences, SKUAST-K, Shuhama, Alustang, Srinagar.

Professor Rustam Djumayev

Professor of the Department of "Oriental Policy and International Relations" of the Tashkent State University of Oriental Studies

Uzbekistan

Dr. Karno Kumar Mondal(Ph.D)

Teaching Assistantship Undergraduate Lab Department of Physics Khulna University of Engineering & Technology, Khulna-9203

Dr. Begzodbek Kh. Abdullaev(Doctor of Philosophy in Philology)

Associate professor , Andijan State Universitys

Andijan Region, Altynkul District

Dr Farida T. Rabbimova(Doctor of Pedagogical Sciences)

Senior Lecturer of the Department of General Biology and Methods of Teaching ,Jizzakh State Pedagogical Institute

Dr. Rakhimjon Kh. Muradov(Doctor of Philosophy in Technical Sciences)

Senior Lecturer, Namangan Institute of Civil Engineering

Namangan Region, Mingbulak District

Dr. Vishal Dubey (Ph.D)

Director, Department of Pharmaceutical Sciences, Naraina Vidya Peeth Group of Institutions, **INDIA**

Dr. Venkataraman Mugundan(PhD in Mathematics)

Math Lecturer in 'INSTITUTE OF APPLIED TECHNOLOGY',(GOVERNMENT OF ABU DHABI), Fujairah, United Arab Emirates, **U.A.E.**

Dr Muzraf T. Rabbimov(Ph.D)

Associate Professor at the Department of Primary Education at Jizzakh State Pedagogical Institute

Dr Otabek Sh. Ochildiev(Doctor of Philosophy in Technical Sciences)

Head of the Laboratory "Software Management and Mechatronics" of the Research Institute of Agricultural Mechanization

Tashkent Region, Yangiyul District,

Dr Umidbek B. Yusupov(Doctor of Philosophy in Technical Sciences)

Acting Associate Professor of "Vehicle Engineering" Tashkent State Transport University

Tashkent City, Sergeli District,

Dr Abdirasuli A. Ibragimov(Doctor of Philosophy in Technical Sciences)

Scientific Secretary of the Research Institute of Agricultural Mechanization and Electrification

Tashkent Region, Yangiyul District,

Dr. Altinoy Masalieva (Associate Professor Candidate of Historical Sciences)

Uzbek State University of World Languages, Associate Professor of History of Uzbekistan

Dr. Yusup Kh. Manzarov (Associate Professor Candidate of Historical Sciences)

Assistant of the Department of Social Sciences at Karshi Engineering and Economics Institute.

Dr. Durdona A. Mustafoeva (Doctor of Philosophy in Pedagogical Sciences)

Associate Professor (PhD), Department of "Professional Education and Physical Culture", Tashkent Institute of Irrigation and Agricultural Mechanization Engineers,

Tashkent Region, Tashkent District,

Dr. Mamurzhan A. Mirzazhanov (Candidate of Technical Sciences)

Associate Professor of Production of Products and Structures, Fergana Polytechnic Institute of Building Materials

Fergana Region, Oltiariq District

Dr. Mahmudjon M. Ergashev (Candidate of Technical Sciences)

Head of the Department of Production of Building Materials, Products and Structures of Fergana Polytechnic Institute

Fergana Region, Quvasoy City

Dr. Iyanda Kamoru Ahmed (Doctor of Philosophy (Legal and Social History))

Department of History and International Studies, Federal University Gashua, Yobe State, **Nigeria**

Dr. J.GAJENDRA NAIDU (Ph.D In Finance)

Head of the Department, Faculty of Finance Botho university: Gaborone Campus: Botswana

Dr Nilufar M. Turdieva (Doctor of agricultural science)

Chairperson of laboratory Scientific research Institute protection of plants

Uzbekistan

Dr. Kutbiddin B. Imomkulov (Doctor of Technical Sciences)

Trade Specialist for Innovative Projects of Agricultural Research Institute

Tashkent Region, Yangiyul District

Dr. Omer Allagabo Omer Mustafa (PhD. in Economics)

Assistant professor of Economics, Banking and Finance, Sudan Academy for Banking and Financial Sciences (SABFS-Sudan)

Sudan, North Africa

Dr. Cristobal Millenes Ambayon (Doctor of Education)

Associate Professor V Sultan Kudarat State University, College of Teacher Education ACCESS, EJC Montilla, Tacurong City

Tacurong, Philippines

Dr. Khamid M. Sodikov (Doctor of Philosophy in Pedagogical Sciences)

Dean of the Faculty of Physics and Technological Education of Jizzakh State Pedagogical Institute

Jizzakh District, Navoi SFU

Dr. Nazokat G. Juraeva (Doctor of Philological Sciences)

National Institute of Arts and Design named after K.Bekzod, **Tashkent**

Dr. Nwodim Obinna (Doctor of Philosophy (Development Studies))

Department of Political and Administrative Studies, Faculty of Social Sciences, University of Port Harcourt

Nigeria

Dr. Atalla Fahed Al-Serhan (PhD)

Assistant Professor, Department of Business Administration, Al Albayt University, Mafraq, Jordan

Dr Nasiba N. Panjjeva (Doctor of Philological Sciences)

Associate Professor of English Language and Literature, Termez State University

Surkhandarya Region, Termez City

Dr. Shakhlo B. Samanova (Doctor of Philosophy)

Associate Professor of “Theory of building a democratic society in Uzbekistan.” Urgench State University.

Khorezm Region, Urgench District

Dr. Abderraouf Mtiraoui (Ph.D in Economics)

Assistant Professor in Economics at the Higher Institute of Finance and Taxation (HIFT)-Sousse- **Tunisia**

Dr. Muhammad Faizal bin Samat (Doctor of Philosophy (Marketing Communication))

Senior Lecturer at Malaysian Academy of SME & Entrepreneurship Development, Universiti Teknologi MARA, Shah Alam

Malaysia

Dr. Wulan Rahmadhani (Doctor in Public Health)

Lecturer, Department of Midwifery, Sekolah Tinggi Ilmu Kesehatan Muhammadiyah Gombong, **Indonesia**

Dr. Adeboye, N. Olawale (Doctor of Philosophy (PhD))

Department of Mathematics & Statistics, Federal Polytechnic Ilaro, Nigeria

Ewa, Moses Apie (Ph.D)

Lecturer Department of Educational Foundations & Childhood Education, Faculty of Education, Cross River University of Technology (CRUTECH), Calabar, **Nigeria**

Shaimaa Mohamed Hassanin (Ph.D in English Literature)

Lecturer of English language and American literature at Horus University

Damietta, Egypt

Dr. Dildora S. Davronova (Doctor of Philosophy in Pedagogical Sciences)

Associate Professor of “Pedagogy and Psychology” at the Uzbek State University of World Languages

Chilonzor Region Tashkent, Uzbekistan

Dr. Karima J. Tulenova(Doctor of Philosophy)

Acting Head of the Department of Social Sciences, Tashkent State Pedagogical University named after Nizami

Tashkent City, Yakkasaray District

Yannick Boum (Ph.D in English Language)

A researcher from the University of Yaounde **Cameroon, Central Africa**

Dr. Rashmi S (Doctor of Philosophy in Botany)

Assistant Professor, Post Graduate Department of Botany, JSS College of Arts, Commerce and Science (Autonomous) Ooty Road, Mysore, Karnataka, **India**

Dr Abdimurot U. Kuziev(Candidate of Technical Sciences)

Head of the Department of Transport Systems and Structures of Termez State University

Surkhandarya Region, Termez City

Dr. Normakhmat P. Panjiev (Doctor of Philological Sciences)

Head of the Department of Russian Linguistics, Termez State University

Surkhandarya Region, Termez City

Rawda Bashir Abdulla (Ph.D.)

Assistant Professor in Teaching English language and Applied Linguistics, Department of English Language Skills Jouf University Kingdom of **Saudi Arabia**

Dr. Nemat Kh. Kushvaktov(Ph.D Pedagogical Sciences)

Head of the Department of General Pedagogy of Jizzakh State Pedagogical Institute.

Jizzakh City, Navruz Mahalla

Dr Khurshid A. Sattarov (Ph.D.)

Head of the Department of Electronics and Radio Engineering, Tashkent University of Information Technologies named after Muhammad al-Khwarizmi, **Tashkent City, Mirabad District**

Dr. Manoj Kumara.N.V (Ph.D in Finance)

Associate Professor in Department of Management Sciences, Maharaja Institute of Technology- Mysore.

Karnataka, India

Jupeth Toriano Pentang (Doctor of Philosophy Major in Educational Management)

Mathematics Educator, Researcher and Extensionist, College of Education, Western Philippines University Puerto Princesa City,

Philippines

Housseine Bachiri (Ph.D)

Assistant Professor at the Faculty of Sciences and Technologies, Tangier

Tangier (Morocco)

Dr. Sarvarbek Kh. Jumaboev(Doctor of Philosophy in Technical Sciences)

Acting Associate Professor of Power Supply, Tashkent State Transport University

Uchtepa District

Dr. Gulmira J. Tulenova

Professor, Tashkent University of Information Technologies named after Muhammad al-Khwarizmi, Tashkent, Uzbekistan

Uzbekistan

Seham Ismail (Doctor Philosophy in Agricultural Sciences)

Head of Department of Insect Population Toxicology, Central Agricultural Pesticides Laboratory, Agriculture Research Center, Dokki, Giza, Egypt

Egypt

Dr. Veena N (Ph.D. in Educational Psychology)

Associate Professor, Christ Academy Institute for Advanced Studies (CAIAS), Bangalore

Bangalore

Dr. Djuraev Jamolbek Abdulkakharovich (Ph.D.)

Senior Lecturer Department of Otolaryngology and Dentistry TMA

Tashkent

Dr. V.KIRUTHIGA (Ph.D)

Assistant Professor, Department of Management Studies, Faculty of Engineering and Technology, Jawaharlal Nehru Salai, 100 Feet Road, Vadapalani, Chennai-600026

Chennai

Dr. Govind Shinde (Ph.D.)

Professor, Babasaheb Gawde Institute of Management Studies. (Approved Associate Professor Finance Faculty University of Mumbai)

Mumbai

Prof. Dr. Nagham Mahmood Aljamali (Ph.D.)

Professor in organic chemistry, Department of Chemistry, Synthetic Organic Field, IRAQ

Iraq

Dr. Tiziana Ciarambino (Ph.D. in Geriatrics Physiopathology)

Teacher at the University of Campania

Campania

Dr. Kalandarov Palvan Iskandarovich (Doctor of Technical Sciences)

Professor at the Tashkent Institute of Irrigation and Agricultural Mechanization Engineers in Tashkent

Tashkent, Uzbekistan

Dr. MC Manjunatha (Phd.)

Assistant Professor, Department of Civil Engineering, Maharaja Institute of Technology, Thandavapura, Mysuru -571 302

Mysuru

Dr. Sourabodhi Bhattacharyya (Ph.D)

Assistant Professor of Sanskrit (Stage II) Galsi Mahavidyalaya, B.U, Galsi,Purba Bardhaman , W.B-713406
India

Dr. Naftaly Gisore Mose (Ph.D in Economics)

Lecturer (Economics) University of Eldoret

Kenya

Dr. ARTI (Ph.D. in Law)

Assistant Professor, Desh Bhagat University, Punjab

INDIA

Dr. MOTHUKURI ANJALIAH (Ph.D. In Library Science)

Assistant Professor (Dept. of Library and Information Science)

INDIA

Dr. Youssif Zaghwan Omar (PhD in English Education)

General Director of the Institute of Human Resources Development at the Libyan Academy

Libya

Dr. Ndubuisi-Okolo (Ph. D)

Lecturer, Nnamdi Azikiwe University

Nigeria

Dr. Mourad Romdhani (Ph.D. in English Literature)

Assistant Professor, the Faculty of Letters and Humanities, University of Sousse, Tunisia

Tunisia

Dr. Utemuratova Gulshirin Najimatdinovna (PHD in Biological Science)

Karakalpak Scientific Research Institute of Natural Sciences Laboratory of Animal Science, Doctor of Philosophy PHD, Biological Science, Uzbekistan

Uzbekistan

Dr. Tureyev Abat Arisovich, PhD (Doctor of Philosophy (Tourism))

lecturer of technology of storage and processing of agricultural crops, philosopher of Biological Sciences ,Karakalpakstan Institute of Agriculture and Agrotechnology,

Uzbekistan

Dr. Rico Paulo G. Tolentino (PhD in Development Education)

School Principal, Department of Education, Schools Division of Bulacan, Philippines

Philippines

Dr. Nik Alif Amri Bin NikHashim (Doctor of Philosophy (Tourism))

Senior Lecturer (DS51), Faculty of Hospitality, Tourism & Wellness, University **Malaysia Kelantan**

Australia

Shuang Li (Ph.D. in Sociology)

Sociology Lecturer, Department of Sociology and Social Work University of Wisconsin-Stevens Point
Wisconsin

Dr. V.KAVITHA (Ph.D. in English Literature)

Assistant Professor of English, Nehru Arts and Science College (Autonomous), Coimbatore

Coimbatore

Dr. Samieva Gulnoza Utkurovna

Doctor of medical sciences (DSC), Samarkand State medical institute, Uzbekistan

Uzbekistan

ANOKE, Amechi Fabian (Ph.D)

Lecturer, Department of Business Administration, Faculty of Management Sciences; Nnamdi Azikiwe University, Awka, Anambra State **Nigeria**

Dr..L.Bhuvana (Ph.D)

Assistant Professor of Chemistry, Shrimati Indira Gandhi College, Tiruchirappalli
Tamil Nadu, India

Dr. Norjigit T. Nishonov(Candidate of Agricultural Sciences)

Senior Lecturer, Department of Agrochemistry, Soil Science, Plant Protection and Quarantine, Samarkand Veterinary Medical Institute Samarkand Region

Dr. Esirgap I. Turapov(Ph.D)

Associate professor of the Department of "Machine Engineering Technology" at the Almalyk Branch
Jizzakh Region, Galla-Aral District

Dr Alisher J. Shokirov(Doctor of Agricultural Sciences)

Dean of the Faculty of Storage and Processing of Agricultural Products, Tashkent State Agrarian University
Tashkent Region, Yunusobod District

Dr. Patkhillo Siddikov(Doctor of Technical Sciences)

Professor of "Technology of textile fabrics" of the Tashkent Institute of Textile and Light Industry
Tashkent City, Chilanzar District

Suyarova Nargiza Yuldoshevna (Doctor of Philosophy (PhD))

Senior teacher, Philological Sciences, Karshy State University, Uzbekistan

Table of Contents IJMRA Volume 07 Issue 11 November 2024

S.no.	Article	Author's	Page no.
1.	The Transformation of Form and Function on Pottery of Banyumulek Lombok	Nurul Kemala Dewi, Hartono, Syakir	4971-4977
2.	Achievement Goals, Perceived Teacher Support, and Mathematics Achievement: The Mediating Role of Academic Disidentification	Samwel Makori Oyaro, Peter A. Mwaura, Cecilia Nyambura Mwangi, Anthony Muriithi Ireri	4978-4990
3.	Foreign Finance, FDI-Climate Interaction and Economic Development in Ethiopia: A Time Series Analysis	Muhammad Ali, Salam S. Mohammed, Kazeem O. Isah, Ozovehe Abdulsalami	4991-5004
4.	Design and Implementation of Line Follower Robot for Automatic Watering of Orchid Plants	Aep Setiawan, Irzaman, Mahfuddin Zuhri, Muchammad Alifandino Satrio, Herlambang Nurasyid Ramdhani, Muhammad Iqbal, Raihan Abrar Baihaki	5005-5009
5.	Commodity Analysis of Carbohydrate Food Availability in the Banyumas Regency Area	Fitrizka Acha Fimbriata, Mukson, Bambang Dwiloka	5010-5015
6.	The Asean Action towards the Impact Trade War between The Us and China	Cheah Chang Jiang, Noraini Zulkifli	5016-5024
7.	Women Discrimination in Mexico and Impact towards The National Security	Ain Sofea Md Salleh, Noraini Zulkifli	5025-5033
8.	Digital Competency Development Among merchant Vocational Education Lecturers: An Analysis of Personal and Institutional Factors Influencing Teaching Effectiveness in Indonesian Higher Education	Suherman, Sukirno, Taufik Marjaman, Pranyoto, Endah Fauziningrum, Kundori, Sukrisno	5034-5046
9.	Understanding Digital Technology Integration in Merchant Marine College: Examining Teacher Digital Competency through TAM Framework	F. Pambudi Widiatmaka, Pranyoto, Didik Dwi Suharso, Kundori, Riasny dewi Annafril, Sukrisno	5047-5058
10.	Leadership in Sports Organizations: An Overview of Indonesia	Jihan Azrina, Sumaryanto, Suharjana	5059-5065
11.	Visual Pollution: Causes, Health Impacts, And Mitigation Strategies for Enhancing Environmental Aesthetics and Public Well-Being – A Review	Najmaldin Ezaldin Hassan, Sonia Khalil	5066-5080
12.	Some Measures to Advance the Positiveness of Preschool Children in Shaping Activities	Nguyen Thi Ngoc Diep	5081-5086

13.	The Effect of Audio-Visual Learning Media on the Memory of Elementary School Students	Erna Mena Niman, Zephisius Rudiyanto Eso Ntelok, Heronimus Emilianus Arjono Wejang, Stefanus Divan	5087-5091
14.	Examination of the Impact of System Quality, Information Quality, and Service Quality on Net Benefits through User Satisfaction in the Performance of State Civil Apparatus in the Malang District Government	Sigid Tri Hartanto1 , Mokhammad Natsir2 , Yusaq Tomo Ardianto3	5092-5099
15.	Legal Implications of the Cancellation of Document Copies by Court Ruling on Notarial Minutes	Ida Ayu Mira Pratiwi, I Nyoman Sujana, Ida Bagus Agung Putra Santika	5100- 5106
16.	Applicability of Fibonacci Series on Low Beta Stocks of Nifty-50	Veerendra Anchan, Vansh Shah, Vatsal Desai, Rushabh Shah	5107-5112
17.	Management of Sports Facility Owned by Sleman Regency Government during the Pandemic Case Study of Maguwoharjo Stadium	Ridwan Khoiri , Wawan Sundawan Suherman	5113-5117
18.	The Use of Tiktok as a Tool for English Grammar Instruction: An Analysis of the @Excellentinhousetraining Tiktok Account	Elly Tri Suryati, Venny Eka Meidasari, Mashadi Said	5118-5125
19.	Beyond the Schools: How Parental Involvement Affects the Academic Performance of Nepali Public School Students?	Padam Poudel, Dhanapati Subedi, Niroj Dahal	5126-5136
20.	Synergizing Fuzzy AHP and MAUT for Integrated Evaluation of PSU Stocks and Mutual Fund Schemes	Veerendra Anchan, Sahil Shailendra Vaidya, Ankita Jain, Rinkle Chaplot	5137-5151
21.	Prevalence, Morphological Classification, and Factors Associated With Severe Anemia among Children Under 5 Years of Age at Itojo Hospital	Adjira UMUKWIYE Masters, Sylvestre HAVUGIMANA Masters, Bernard Natukunda Phd, Elysee HITAYEZU Masters, Theoneste HAGENIMANA Masters	5152-5158
22.	Entrepreneurial Skills of Student Entrepreneurs	Calvin J. Caliat	5159-5167
23.	Analyze the Physical Performance of Elite Athletes: Relationship between Leg Muscle Explosive Power, Flexibility, and Balance in Elite Taekwondo Athletes Pre-Porprov West Java	Ria Apriliani, Muhammad Furqon Hidayatullah, Haris Nugroho, Slamet Riyadi, Singgih Hendarto	5168-5171
24.	The Effectiveness of Problem-Based Learning Model on Creative Thinking Skills in Class V Elementary School in Wonogiri Sub District	Sandra Bayu Kurniawan	5172-5176
25.	Retrospective Study of Fine Needle Aspiration Cytology of Patients with Thyroid Nodule in Benghazi in the Period of (2021- 2023)	Lobna Abdalla Elfrgani, Ghazala Othman Ali Elfeitouri, Mona Adnan Elkhattib, Mona Moftah Alabbar, Salha Abdullah Alobidy, Sally Ali khalaf, Abeer H. Amer	5177-5182

26.	Assessment of Land Damage Status Using Frequency Method on Several Land Use for Biomass Production in Payakumbuh City	Aprisal, Teguh Haria Aditya, Resin	5183-5191
27.	Theory of Self-Serve Skills Education for 3-4 Years Kindergarten Children in Daily Living Regime	Nguyen Thi Hong, VO Nguyen Doan Trinh, Le Thi Hong Xuan	5192-5197
28.	Guided Inquiry Design (GID) as a Pedagogical Practice in Teaching Practical Research	Mustaham, Judith C.	5198-5204
29.	Coping Mechanisms of Mathematics Teachers in a Modular Distance Learning in the Selected Secondary Schools in the Division of Ilocos Sur	Annaliza Q. Elizarde	5205-5216
30.	The Influence of Achievement Motivation on Burnout in Swimming Athletes	Elsadirra Ayu Melya, Christina Fajar Sriwahyuniati, Endang Rini Sukamti	5217-5222
31.	PISA-Based Assessment Instrument In Javanese Language Learning Grade VIII	Iriana Famuji Widodo, Suwarnda, Venny Indria Ekowati	5223-5233
32.	Third-Person Passive Voice in Illustrative Explanatory Speech Acts by Residents of Sumberejo, Ambulu, Jember	Adinda Alfiranda Zahroh, Afendy Widayat, Ahmad Rizky Wahyudi	5234-5244
33.	Digital Fraud: Analyzing the Latest Trends and Tactics in Cybercrime	Mujiono Hafidh Prasetyo, Ahmad Ainun Najib	5245-5248
34.	Negative Effects of Digital Technology on Children's Health	Najiba Sharaf, Dr. Ayesha Bahez, Engila Akhtary	5249-5255
35.	Images of Buddha and the Great Deities of Brahmanism in the Original Buddhist Pantheon from the Practice of Thailand and Vietnam	Vu Hai Thien Nga	5256-5261
36.	Ṣaṭ Pāramitā and Its Application Values in Building Ethics of Vietnamese Business People Today	Le Quoc Binh	5262-5267
37.	Maternal Health Service Utilization and Women's Health Care Decision-Making Autonomy in Ethiopia	Nasser B. Ebrahim	5268-5272
38.	The Argument Structure of Intransitive Verbs in Toba Batak Language Aek Kanopan Dialect: A Grammatical Typology Analysis	Asridayani, I Ketut Artawa, I Nyoman Udayana, Ketut Widya Purnawati	5273-5281
39.	Diversity of Medicinal Plants in Nubamado Village, Lembata District to Cure Livestock Diseases	Anyela Merici Beto Odjan, Agung Wijaya Subiantoro	5282-5287
40.	Comparison of PMH Arrangements in Indonesia and the Netherlands in Transportation Matters	Ni Kadek Manik Lely Kamani, Salsah Puri Dewi, Lorin Imogen, Frity Felicia Anton, Giorgio Geissler Vallerio Tjua Mottoh	5288-5296
41.	Substantive and Procedural Justice Principles in the Implementation of Industrial Court Decisions: Challenges and Solutions	Muhammad Ramdan, Ardina Nur Amalia	5297-5302
42.	Smart Strategies in the Digital Age: Conventional Retail Facing the Revolution E-Commerce	Chris Partogi, Mochamad Heru Riza Chakim, Mulyati	5303-5309

43.	The Importance of Digital Literacy in Enhancing the Quality of Education and Social Harmony	Willy Bachtiar, Wahyu Budi Priatna, Hudi Santoso, Abung Supama Wijaya, David Rizar Nugroho	5310-5317
44.	The Urgency of Integrating Femicide Norms to Achieve Gender Equality in the Sustainable Development Goals	Raja Ramadhan, Aditya Yuli Sulistyawan	5318-5323
45.	Interaction between Training Methods and Eye-Foot Coordination on Football Passing Ability	Maulana Rahmawanto, Muchsin Doewes, Hanik Liskustyawati, Slamet Riyadi	5324-5327
46.	Online Dispute Resolution (ODR): Pillar of a Modern and Inclusive Judicial System in Indonesia	Ardina Nur Amalia, Muhammad Ramdan	5328-5333
47.	Measures: The New Face of Criminal Punishment in the New Indonesian Criminal Code	Feri Satria Wicaksana Effendy, Umaira Hayuning Anggayasti	5334-5338
48.	Sustainable Oyster Mushroom Livelihood Development Project for Rural Communities of Ilocos Sur	Mary Ruth O. Menor	5339-5359
49.	Effect of Environmental Impact Assessment and Management on the Economic Growth of Developing Countries. Evidence from Nigeria. (1990-2023).	Elizabeth Ayuba Kwajaffa, Tamatuwa Kadiri Angulu, Taiwo Adewale Muritala (Ph.D), Rahila Timothy Dantong(PhD), ATAYI Abraham Vincent (Ph.D)	5360-5369

The Transformation of Form and Function on Pottery of Banyumulek Lombok



Nurul Kemala Dewi¹, Hartono², Syakir³

¹Faculty of Teacher Training and Education – Mataram University - Indonesia

^{2,3}Postgraduate of Semarang State University – Semarang - Indonesia

ABSTRACT: The pottery of banyumulek Lombok has existed since ancient times, dating back to the Sasak kingdom, and continues to the present day. This study aims to analyze the transformation of form and function in Banyumulek Lombok pottery. Qualitative research uses data collected through observation, interviews, and documentation. The pottery samples were collected purposively. The data analysis method uses the Miles and Huberman model, which involves data reduction, display, and conclusion drawing. The research findings show that before 1988, the appearance of Banyumulek Lombok pottery needed to be more varied and was used solely for daily household purposes. After 1988, variations on form began to emerge, and today, there are numerous forms with various creative designs.

KEYWORDS: Transformation, Form, Function, Pottery, Banyumulek Village

I. INTRODUCTION

Indonesia is immensely rich in regional arts and culture, with hundreds of ethnic groups contributing to this diversity. According to the 2024 National Statistics Agency, there are 633 major ethnic groups in Indonesia, and every Indonesian citizen must preserve Indonesia's region's vibrant cultural and artistic heritage must be preserved.

One such ethnic group is the Sasak people, native to the island of Lombok. Lombok, one of the larger islands in West Nusa Tenggara Province, covers an area of 5,179 km². In 2024, the West Nusa Tenggara Statistics Agency recorded a population of 3,933,780 in Lombok, making up 70% of the province's total population. Lombok is home to various traditional arts, including music, theater, dance, and crafts. One prominent craft in Lombok is pottery, particularly in Banyumulek Village, West Lombok Regency.

Based on an interview with the head of Banyumulek Village's tourism awareness group, Mr. Zainuddin, he stated that the pottery tradition in Banyumulek began with Papuk Mulek and was later continued by Ida Wayan Tata. Banyumulek pottery has existed since the time of Papuk Mulek during the Sasak Kingdom, primarily used as household items. Ida Wayan Tata further developed its function and form in 1859, after the Karangasem Kingdom of Bali occupied some of the Lombok region. Ida Wayan Tata was granted permission to reside in Banyumulek by the Karangasem Kingdom, which held power then. This account aligns with the statement by Ketut Muka and Wayan Suardana (2023), who noted that in 1859, Ida Wayan Tata was authorized to settle in Banyumulek as a representative of the Karangasem Kingdom. In 1862, he converted to Islam, adopting the name Ibrahim, and expanded pottery production to include daily necessities, especially utensils for food, drink, and religious ceremonies.

This pottery-making skill gradually became a tradition in the area, with many locals producing everyday household items from clay. In 1988, New Zealand contributed to developing the pottery industry, helping to market Banyumulek pottery abroad, particularly to Australia and New Zealand. Sastrawati (2021) revealed that in the 1980s, Banyumulek pottery began to grow better and was sold commercially, thanks to the collaboration between New Zealand and Indonesia to support this industry. Following this international collaboration, the form and function of Banyumulek pottery underwent a gradual transformation. The growth of Lombok's tourism industry has significantly accelerated the evolution of pottery designs in Banyumulek, resulting in a wider range of styles.

The enduring tradition of Banyumulek pottery offers a valuable area of study, which can help deepen appreciation for this age-old craft. Previous research on Banyumulek pottery includes an analysis by I Ketut Muka and I Wayan Suardana (2023) titled

The Transformation of Form and Function on Pottery of Banyumulek Lombok

Innovation of Form and Function of Banyumulek Pottery Craftsmanship in Lombok as Heritage of Traditional Culture, which examines the form and function of Banyumulek pottery but does not address its transformation. Another study by Sastrawati et al. (2021) titled Pottery in Banyumulek Village, Kediri Subdistrict, West Lombok Regency discusses the form, function, and decoration of Banyumulek pottery without exploring its transformation. Usman Hadi (2020) conducted a study titled Community Empowerment Through Pottery Crafts in Banyumulek Village, which focuses on efforts to empower local potters but does not address changes in form and function. Finally, Nila Kusuma Dewi (2015) conducted a study titled Tinggang Pottery Crafts in Banyumulek Village, Kediri Subdistrict, West Lombok, which discusses the form and function of Tinggang pottery produced in a hamlet of Banyumulek, without examining the transformation of Banyumulek pottery more broadly.

None of these studies specifically address the transformation in form and function of Banyumulek pottery, particularly before and after the bilateral cooperation between New Zealand and Indonesia. According to the Kamus Besar Bahasa Indonesia (Great Dictionary of the Indonesian Language), transformation refers to changes in form and function. Based on this background, the research problem can be formulated as: How has the form and function of Banyumulek pottery transformed over time?

II. METHODS

This qualitative research focuses on field observations to understand the subject's context in pottery's natural habitat. Sugiyono (2019) notes that qualitative research, often naturalistic, is conducted in real-world settings. The data collection methods included documentation, observation, also with interviews. Pottery samples were selected purposively, and the data analysis followed the Miles & Huberman model, which involves data display, data reduction, also conclusion drawing.

III. LITERATURE REVIEW

1. Form and Function of Pottery

Pottery is a traditionally hand-made craft initially designed to help basic living needs, particularly regarding tools and utensils. Over time, humans, driven by aesthetics, began to create pottery with more attractive designs. Pottery is made from clay, shaped according to necessity or desire, and fired to ensure durability. Putri (2023) notes that pottery is a craft made from clay that is fired and shaped into various household items or used as room decorations.

Pottery has existed for thousands of years. In Indonesia, pottery has been present since prehistoric times. Several studies have confirmed this. For instance, Kasnowihardjo (2017) stated that pottery is a technological advancement that developed during the Neolithic period. Even today, some communities in Central Java, particularly in the northern coastal region of Rembang Regency, continue to produce pottery, such as in the village of Balong Mulyo.

Additionally, Atmosudiro (1998) noted that in Indonesia, pottery in the form of containers emerged during the farming period, approximately 2500–1500 BC. During this period of settled agriculture, the need for tools increased for farming activities and containers such as those used for food, drink, and cooking. Consequently, pottery-making skills were regarded on par with the stone-tool crafting abilities of that era, such as making square axes, also used in farming. Similarly, Rangkuti (2001) argued that combining the four natural elements—earth, water, air, and fire—was an innovation. The innovation of terracotta is believed to have originated during the Neolithic period and developed gradually over a long period. Based on these opinions, it can be concluded that pottery has existed in Indonesia since prehistoric times, specifically during the Neolithic era, around 2500–1500 BC.

Pottery is a three-dimensional object, and it can generally be classified into two forms: geometric (regular) and non-geometric (irregular). Sabatari (2006) explained that geometric forms can be measured or based on geometric principles, while non-geometric forms cannot be measured this way.

Form is one of the critical elements of visual art. According to the Kamus Besar Bahasa Indonesia (Great Dictionary of the Indonesian Language), "form" refers to the shape or structure of an object. The principles of visual art analyze the aesthetics of two-dimensional and three-dimensional forms. Hidayatullah (2016) and Dewi (2023) state that the principles of visual art are guidelines used in organizing the elements of art. These principles include unity, harmony, balance, rhythm, emphasis, and proportion.

Based on the explanations above, this study will analyze Banyumulek pottery in terms of its three-dimensional form, using the principles of visual art: proportion, rhythm, harmony, balance, emphasis, and unity. The function or utility of each piece of pottery will also be discussed.

Pottery is a handmade craft initially designed to meet basic living needs, particularly in terms of tools and utensils. Over time, humans, driven by a sense of aesthetics, began to create pottery with more attractive designs. Pottery is made from clay, shaped according to necessity or desire, and then fired to ensure its durability. As noted by Putri (2023), pottery is a craft made from clay that is fired and shaped into various household items or used as room decorations.

The Transformation of Form and Function on Pottery of Banyumulek Lombok

Pottery has been in existence for thousands of years. In Indonesia, pottery has been present since prehistoric times. Several studies have confirmed this. For instance, Kasnowihardjo (2017) stated that pottery is a technological advancement that developed during the Neolithic period. Even today, some communities in Central Java, particularly in the northern coastal region of Rembang Regency, continue to produce pottery, such as in the village of Balong Mulyo. Additionally, Atmosudiro (1998) noted that in Indonesia, pottery in the form of containers emerged during the farming period, approximately 2500–1500 BC. During this period of settled agriculture, the need for tools increased, both for farming activities and for containers such as those used for food, drink, and cooking. Consequently, pottery-making skills were regarded on par with the stone-tool crafting abilities of that era, such as making square axes, which were also used in farming. Similarly, Rangkuti (2001) argued that the idea of combining the four natural elements—earth, water, air, and fire—was an innovation. The innovation of terracotta is believed to have originated during the Neolithic period and developed gradually over a long span of time. Based on these opinions, it can be concluded that pottery has existed in Indonesia since prehistoric times, specifically during the Neolithic era, around 2500–1500 BC.

Pottery is a three-dimensional object, and it can generally be classified into two forms: geometric (regular) and non-geometric (irregular). Sabatari (2006) explained that geometric forms are those that can be measured or are based on geometric principles, while non-geometric forms cannot be measured in this way.

Form is one of the key elements of visual art. According to the Kamus Besar Bahasa Indonesia (Great Dictionary of the Indonesian Language), "form" refers to the shape or structure of an object. To analyze the aesthetics of both two-dimensional and three-dimensional forms, the principles of visual art are used. Hidayatullah (2016) and Dewi (2023) state that the principles of visual art are guidelines used in organizing the elements of art. These principles include unity, harmony, balance, rhythm, emphasis, and proportion.

Based on the explanations above, this study will analyze Banyumulek pottery in terms of its three-dimensional form, using the principles of visual art: proportion, rhythm, harmony, balance, emphasis, and unity. Additionally, the function or utility of each piece of pottery will also be discussed.

2. Lombok Island

The province of West Nusa Tenggara (NTB) comprises two main islands, Lombok and Sumbawa, along with numerous smaller islands. Lombok lies west, bordering Bali, while Sumbawa is on the eastern side, bordering East Nusa Tenggara. NTB covers a total area of 20,153.20 km², situated between 115° 46' and 119° 5' East Longitude and 8° 10' and 9° 5' South Latitude. Sumbawa Island is about two-thirds of the province, covering 15,414.5 km² (76.49%), while Lombok accounts for the remaining third, or 5,440 km². The provincial capital, Mataram, is located on Lombok Island. Selong, at an elevation of 166 meters above sea level (m.a.s.l.), is the highest town in NTB, while Taliwang, at 11 m.a.s.l., is the lowest. Mataram, the capital, stands at 27 m.a.s.l. Among Lombok's seven mountains, Mount Rinjani is the tallest, rising to 3,726 m.a.s.l., whereas Sumbawa's highest peak is Mount Tambora at 2,851 m.a.s.l.

Lombok is home to 3.93 million people, making up 70% of West Nusa Tenggara's population. The Sasak people, who make up 80% of the island's inhabitants, are the indigenous ethnic group (<https://ntbprov.go.id/profil-daerah>). Historically, Lombok has experienced a series of conflicts and invasions, from the Majapahit Kingdom to the Japanese occupation. According to Sanusi (2018), historical records indicate that Lombok came under the Majapahit Kingdom's control in 1357. By 1672, the Karangasem Kingdom of Bali had conquered the Kingdom of Selaparang in Lombok. The Dutch took control of the island in 1908, and it was later occupied by Japan in 1942. West Nusa Tenggara was officially established as a province on August 14, 1958, under Law No. 64 of 1958, alongside Bali and East Nusa Tenggara. The province's first governor was AR Moh. Ruslan Djakraningrat.

IV. FINDINGS AND DISCUSSIONS

As previously mentioned, the collaborative efforts between both the Indonesian and New Zealand governments in 1988 were important in advancing the development of Banyumulek pottery in Lombok, both in terms of form and function. Before this collaboration, the Indonesian government had initiated efforts to support Banyumulek pottery by sending artisans to Kasongan Village for comparative studies. Nurjannah (2004) reports that in 1979, the Department of Industry in West Lombok provided artisans in Banyumulek with production tools, and in 1983, they were sent to Kasongan, Yogyakarta. However, these initiatives needed further guidance on model development and several advancements in Lombok.

In 1988, the Lombok Pottery Centre (LPC) introduced a more comprehensive development program focusing on production techniques and marketing. From 1988 to 2005, the LPC offered intensive training. This center was established as part of a bilateral project between Indonesia and New Zealand (<https://www.fairtradeindonesia.com/> et al.). Thanks to the LPC's support, which included assistance in marketing abroad, Banyumulek pottery experienced a major shift. Initially, artisans produced pottery mainly for home use, but after the program, production became increasingly geared towards commercial sales.





The Transformation of Form and Function on Pottery of Banyumulek Lombok

From the history above, the evolution of Banyumulek pottery can be categorized into two phases: pre-1988, before the training program initiated by LPC in collaboration with New Zealand, and post-1988, when extensive training and support resulted in notable advancements. The following sections will deliver thorough insights into these phases:

1. The Form and Function of Lombok Pottery Before 1988

Based on the results of observations and interviews, the following presents several original forms of Banyumulek pottery along with their functions:

Table 1. Initial Forms and Functions of Banyumulek Lombok Pottery

No	Category	Form	Function	Description
1	Flower Vase		Flower Vase	The pottery features a symmetrical form and terracotta color, with a height of 22 cm and a base diameter of 8 cm, primarily focusing on functionality.
2	Bowl		Vegetable Bowl	The pottery is symmetrical, terracotta-colored, with an 18 cm diameter and a 9 cm height. It lacks variation and is designed purely for functional purposes.
3	Jug		Drinking water jug	The piece is black in color, asymmetrical, 36 cm tall, and has an 18 cm belly diameter. It is designed solely for practical use.
4	Plate		Food Plate	This pottery has a symmetrical form, is terracotta in color, and has a 21 cm diameter, emphasizing function over aesthetics.
5	Mug		Drinking Mug	The piece is symmetrical, terracotta-colored, with a 7 cm diameter, focusing entirely on utility.

Source: Personal Documentation

All pottery forms described above showed little variation in shape and decoration. The production of pottery was primarily aimed at fulfilling daily needs, such as providing utensils or containers for eating, drinking, and other practical uses, rather than being economically driven. Although the craftsmanship was excellent, there was little adjustment on its aesthetic aspects, such as adding decorative elements or adding specialized techniques to enhance the appearance of the pottery.









2. Variations in the Forms and Functions of Lombok Pottery Today

Based on observations and interviews, the following presents several types of Banyumulek pottery after receiving guidance and development:



Table 2. Variations in the Form and Function of Banyumulek Pottery in Lombok Today

No	Category	Form	Function	Description
1	Flower vase		Flower vase and interior display	Symmetrical Shape, Black Background with Floral and Leaf Patterns. This vase stands 40 cm tall with a wide base and narrow top. The floral and leaf motifs are hand-painted, with large red flowers bordered in black, especially prominent in the center. The bold floral design at the base serves as a focal point. Function: Can serve as a flower vase or decorative piece.

The Transformation of Form and Function on Pottery of Banyumulek Lombok

			Flower vase and interior display	Symmetrical Shape, Terracotta Color, 25 cm Tall. The body features Arabic calligraphy of "Allah" and "Muhammad" created by painting directly onto the pottery surface, which acts as a visual focal point. Function: Works as both a flower vase and a decorative item.
			Flower vase and interior display	Symmetrical Shape, 36 cm Tall. This bottle-shaped vessel is coated with sand, and the surface is colored in a mix of yellow, white, black, and cream, forming abstract curved lines. A black accent on the belly serves as the focal point. Function: Suitable as both a flower vase and display item.
			Flower vase and interior display	Asymmetrical Shape, 34 cm Tall. The background is maroon, adorned with small, neatly arranged cream-colored squares made from eggshell pieces, particularly concentrated at the base. Function: Primarily decorative.
2	Bowl		Food bowl and simple interior display	Symmetrical Shape, 18 cm Diameter. The background is a deep black, with yellow and green variations and a large red flower as the focal point. Function: Decorative.
3	Plate		Food plate and interior display	Symmetrical Shape, 25 cm by 25 cm. The background utilizes the natural terracotta color of the pottery, with a depiction of a traditional Sasak barn (lumbung) in blue at the center. The edges are decorated with yellow and blue ornaments, with the blue echoing the central barn motif for visual unity. Function: Decorative plate.
			Food plate and interior display	Symmetrical Plate, 21 cm Diameter. Adorned with repetitive triangular motifs, the plate's surface is decorated with eggshell pieces. The natural terracotta background is left exposed to create an earthy aesthetic. Function: Decorative plate.
			Food plate and interior display	Symmetrical Plate, 21 cm Diameter. The rim is woven with natural-colored rattan, and a butterfly motif, etched into the center, serves as the visual focal point. The background retains the natural brown terracotta hue, enhancing the organic feel. Function: Decorative plate.
4	Mug		Mug and interior display	Symmetrical Shape, 7 cm Diameter. The background is a deep black with floral and vine ornaments. The vines are painted white and yellow, with a large red flower at the center acting as a focal point, enhancing the overall appeal of the cup. Function: Decorative cup.
5	Jug		Water jug and interior display	Asymmetrical Shape, 35 cm Tall. This water jug has a curved bottle shape, with a handle extending from the top attached to the mouth of the container. The handle is adorned with decorative rings. The surface is finished with white paint sprayed over a dark blue

The Transformation of Form and Function on Pottery of Banyumulek Lombok

			background, creating an abstract pattern. Function: Water jug.
		Water jug and interior display	Asymmetrical Shape, 35 cm Tall. Similar to the previous water vessel, but differing in both shape and color. This jug features a large central body, a narrower base, and an even smaller mouth. The handle and painting technique are the same as the previous piece, but the color scheme is white on a yellow background. Function: Water jug.

Source: Personal Documentation

Several examples of pottery in the table above have experienced developments in terms of form and function. The shape of the pottery is varied with incision techniques, eggshell mosaics, weaving, and coloring techniques using paints such as splashes of paint or using a paintbrush.

The shape of the pottery after the guidance from the Lombok Pottery Center, which is a collaboration between the Indonesian government and New Zealand, has experienced rapid development. Many new creations have been produced. Moreover, supported by the rapid development of tourism in Lombok, pottery crafts have continued to develop. Until now, craftsmen continue to be creative to produce new models, although the old models are still maintained. If in the past pottery was only for daily tool needs, now it is switched, becomes a display and souvenir.

V. CONCLUSION

The shape of Banyumulek pottery before 1988, namely before the bilateral cooperation between the Indonesian government and New Zealand, had not shown any variation, had not been traded and prioritized its function only. The types include flower vases, containers, jugs, jars, plates, and glasses.

Meanwhile, after 1988, Banyumulek pottery experienced many changes in form and function and shifted to an economic function, namely for sale. The forms that have undergone many transformations include jugs or water containers, flower vases, plates, and glasses/cups. Pottery has transformed from a function of use to a function of display/decoration.

REFERENCES

- 1) Atmosudiro, S. 1998. Benefits of the Study of Past Pottery for Development Pottery Crafts as a Support for the Tourism Industry, *Berkala Arkeologi*, 18(2), 1-11
- 2) Dewi, Nila Kusuma; Suartini, Rediasa (2015), *Tinggang Pottery Crafts in the Village Banyumulek, Kediri District, West Lombok*, *Jurnal Pendidikan Seni Rupa Undiksha*, 5 (1).
- 3) Dewi, Nurul Kemala. 2023. Analysis of Ability to Design Art-Themed Posters NTB Culture in Prospective Elementary School Teacher Students. *Gorga: Jurnal Seni Rupa*, 12(1).
- 4) Hidayatullah, Ryan. 2016. *Art Aesthetics*, Yogyakarta: Arttex, ISBN: 978-602-60636-1-8
- 5) Kasnowihardjo, G. 2017. Prehistorical-Protohistorical Pottery in the Pantura Area Central Java: Study of Raw Materials Based on Petrographic Analysis, *Kalpataru*, 26(2), 147-160.
- 6) Muka, I. K., & Suardana, I. W. 2023. Innovation of Form and Function of Banyumulek Pottery Craftsmanship in Lombok as Heritage of Traditional Culture. *Harmonia: Journal of Arts Research and Education*, 24(1), 36-50
- 7) Nurjannah, Siti. 2004. The Change of Production Patterns of Craft Community in Pottery Industrial Development (Case Study at Banyumulek Village, West Lombok, West Nusa Tenggara, *Agrimansion*, Vol. 5 No. 01; Nopember 2004: 70-82
- 8) Putri, Yuliana Khairi; Gede Eka Harsana Koriawan, Agus Sudarmawan. 2023. Decoration of Pottery Crafts in Penakak Village, East Lombok Regency, *Jurnal Pendidikan Seni Rupa Undiksha*, 13(3), 210-217.
- 9) Rangkuti, N. 2001. Terracotta Historical Period in Indonesia: Functions and Technology. *Berkala Arkeologi*, 21(1), 57-67.
- 10) Sanusi, Dedy Wahyudin. 2018. The Identity of the Sasak People: An Epistemological Study of the Knowledge Production Mechanism of the Sasak Tribe Community. *Jurnal Penelitian Keislaman*, 14(1).

The Transformation of Form and Function on Pottery of Banyumulek Lombok

- 11) Sabatari, Widyabakti. 2006. Art: Between Form and Content, Imaji: Jurnal Seni dan Pendidikan Seni, 4(2).
- 12) Sastrawati, Wayan Nandaria Putri, Luh Suartini, I Nyoman Rediasa. 2021. Pottery in Banyumulek Village, Kediri District, West Lombok Regency, Jurnal Pendidikan Seni Rupa Undiksha Vol. 11(2), pp. 91-102, 2021
- 13) Sugiyono. 2019. Quantitative, Qualitative and R&D Research Methods, Bandung: Alfabeta.
- 14) Usman Hadi. 2022. Community Empowerment Efforts Through Pottery Crafts in Banyumulek Village. Thesis of the Faculty of Da'wah and Communication Sciences, State Islamic University of Mataram.
- 15) Wahyudin. 2024. West Nusa Tenggara in numbers. Volume 44
- 16) <https://amazingnusantara.com> Lombok Pottery Center: Handcrafted Pottery with a Purpose Lombok Pottery Center: Handcrafted Pottery with a Purpose - Amazing Nusantara 2024, in access 16-9-2024
- 17) PressReader.com - Digital Newspaper & Magazine Subscriptions, The NZ-Lombok Connection, 2013 in access 19-9-2024
- 18) <https://www.fairtradeindonesia.com> in access 19-9-2024
- 19) <https://getlost.id/2021> in access 21-9-2024



There is an Open Access article, distributed under the term of the Creative Commons Attribution – Non Commercial 4.0 International (CC BY-NC 4.0) (<https://creativecommons.org/licenses/by-nc/4.0/>), which permits remixing, adapting and building upon the work for non-commercial use, provided the original work is properly cited.

Achievement Goals, Perceived Teacher Support, and Mathematics Achievement: The Mediating Role of Academic Disidentification



Samwel Makori Oyaro¹, Peter A. Mwaura², Cecilia Nyambura Mwangi³, Anthony Muriithi Ileri⁴

¹Ph.D. Student, Department of Educational Psychology, Kenyatta University, Kenya

²Associate Professor, Department of Educational Psychology, Kenyatta University, Kenya

^{3,4}Lecturer, Department of Educational Psychology, Kenyatta University, Kenya

Corresponding Author: Samwel Makori Oyaro (Email: samoyaro@gmail.com)

ABSTRACT: In a competency-based curriculum (CBC), the development of logical and critical thinking skills in mathematics is essential. As a cornerstone of Science, Technology, Engineering, and Mathematics (STEM), mathematics is pivotal for addressing real-world challenges. However, overall pass rates remain unsatisfactory in Kenyan secondary schools, particularly in Kisii County. This study investigated the mediating role of academic disidentification in the relationship between achievement goals, perceived teacher support, and mathematics achievement. Grounded in the revised 3x2 Achievement Goal Model, Self-Determination Theory, and Expectancy-Value Theory, a correlational design was employed with a random sample of 418 Form Three students from thirty seven schools in Kisii County; Kenya in 2023. Multiple linear regression analysis revealed that academic disidentification partially mediates the relationship among achievement goals, perceived teacher support, and mathematics achievement. School categories differed significantly in avoidance motivation, with co-educational schools exhibiting the highest levels. Based on these findings, the study recommends that mathematics teachers prioritize fostering approach motivation, especially in co-educational schools, to enhance student achievement in mathematics.

1. INTRODUCTION

In recent years, Science, Technology, Engineering, and Mathematics (STEM) education has gained prominence for its vital role in fostering essential 21st-century skills, including critical thinking, problem-solving, and technological literacy. These skills are crucial for developing a competitive workforce capable of addressing complex global challenges. Central to effective STEM education is a solid foundation in mathematics; as Shaughnessy (2013) notes, "the M in STEM will become insignificant if not given significant attention" (p. 324) within integrative educational programs.

Literature indicates that mathematical competence not only enhances systematic thinking but also nurtures creativity and data analysis - skills indispensable in STEM fields (Just & Siller, 2022; McKenna, 2023; Nufus et al., 2024; Wang et al., 2023; Yildirim & Yilmaz, 2023). According to McKenna (2023), students with a robust foundation in mathematics are better positioned to become the next generation of innovators and problem solvers. However, despite its critical role in fostering innovation, mathematics achievement remains persistently low, both globally and in Kenya (Namkung et al., 2019; Mazana et al., 2020; KNEC, 2022).

Recent research has increasingly highlighted the importance of achievement goals (Vergara, 2021; Wu, 2023) and perceived teacher support (Li et al., 2023; Wang et al., 2024; Zhou et al., 2024) in influencing mathematics performance. Yet, a key question arises: do these relationships endure when students psychologically withdraw from academics? This study examines the mediating role of academic disidentification in the connections between these factors and mathematics achievement.

Grounded in the 3x2 trichotomous model of goal orientation (Elliot et al., 2011) and Self-Determination Theory (Ryan & Deci, 2000), this research posits that student motivation thrives when the needs for competence, autonomy, and relatedness are

Achievement Goals, Perceived Teacher Support, and Mathematics Achievement: The Mediating Role of Academic Disidentification

satisfied—needs significantly shaped by teacher interactions. When students experience academic disidentification (Kim & Meister, 2023), the benefits of achievement goal orientation and social support may erode, as students tend to devalue academic performance (Major et al., 1998).

Motivational literature highlights complex interconnections among the study variables. Research indicates that achievement goals serve as antecedents, while academic performance is an outcome influenced by value judgments (Hulleman et al., 2008; Ncororo et al., 2022; Osborne & Jones, 2011). Furthermore, academic achievement has been shown to be predicted by both achievement goal orientation (Ndyareeba et al., 2024; Ng'ang'a et al., 2018; Werunga & Odera, 2022) and the related construct of identity (Ileri, 2015; Ileri et al., 2015; Ileri et al., 2021; Radišić et al., 2024).

Goal orientation profiles are particularly linked to perceived instructional strain (Pulkka & Budlong, 2022) and students' perceived costs associated with studying mathematics (Tuominen et al., 2020). Together, goal orientation and value beliefs predict academic achievement (Hunsu et al., 2023). Given that teachers are significant external influences on students' achievement goals (Zhong et al., 2023), teacher support has been found to correlate with the value students assign to academic tasks (see Möller, 2024, for a review). Additionally, Loose et al. (2012) and Carvalho et al. (2021) highlight the intricate relationships between academic discounting, teacher feedback, and student engagement, emphasizing the need for a nuanced understanding of these dynamics. It was thus conceptualized that academic disidentification mediates the relationships among achievement goal orientations, perceived teacher support, and academic achievement (see Figure 1).

However, most existing research focuses on college samples from the Global North, with secondary school students in the Global South largely underrepresented. Responding to calls for more diverse perspectives in psychological research (Balva et al., 2022; Puthillam et al., 2023), this study investigates academic disidentification as a mediator between achievement goals, perceived teacher support, and mathematics achievement among secondary school students in Kenya. It is anticipated that when students devalue academic tasks, this devaluation will mediate the relationships among achievement goal orientation, perceived teacher support, and academic achievement.

Figure 1: Conceptual Framework

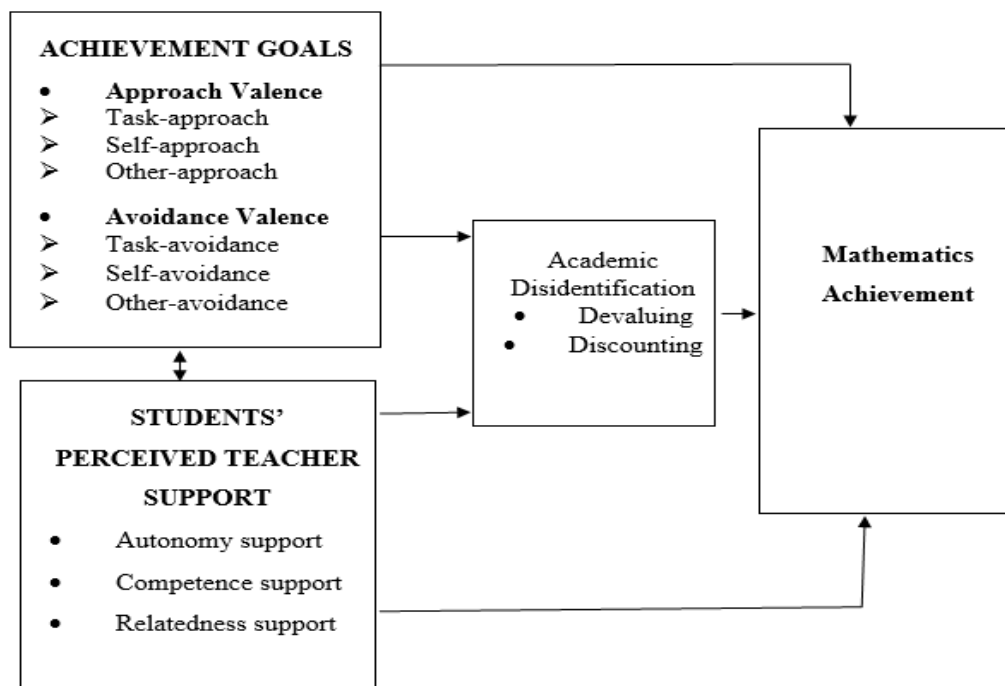

Note. —> Anticipated relationships; <—> Interrelationships among variables

Achievement Goals, Perceived Teacher Support, and Mathematics Achievement: The Mediating Role of Academic Disidentification

2. METHODOLOGY

2.1 Research Design

This study embraced a correlational design (Creswell, 2018) to ascertain the relationships exist between AGs, perceived teacher support, and mathematics achievement. Importantly, the design was suitable in exploring the mediating role of academic disidentification in the relationships between AGs, perceived teacher support and mathematics achievement.

2.2 Sampling

Thirty-seven secondary schools were selected through stratified sampling across four categories in Kenya: National, Extra County, County, and Sub-County. Participants were then chosen via simple random sampling within each category, ensuring equal selection probability, as noted by Fowler and Lapp (2019). Following the guidelines established by Gill et al. (2010), a sample size of 322 was deemed adequate for our target population of 2,000 form three students. Consistent with the recommendation by Israel (2020), the sample size was adjusted by 30% to account for possible non-response and incomplete questionnaires, yielding a final sample size of 418 participants.

2.3 Research Instruments

Section I consisted of demographic information: A demographic information form captured the participants' age, gender, school category, and the school type. Section II had sets of questionnaires - Achievement Goal Questionnaire (AGQ) used to measure achievement goals, modified Teacher as Social Context Questionnaire (TASC – Student Version) used to measure perceived teacher support, and Modified Intellectual Engagement Inventory (MIEI) used to measure academic disidentification. An average of mathematics scores end of term one and term two, 2023 converted to Z scores were used to measure mathematics achievement. The instruments comprised of closed-ended items.

2.4 Procedure

Self-administered questionnaires were used for data collection. Prior to this, the researcher informed the principals of the selected schools about the study's purpose and arranged a specific date and time for data collection. Participants were given 20-30 minutes to complete the questionnaires, accommodating individual differences in response time. Additionally, Form Three class teachers provided the researcher with the mathematics examination scores from the end of Term One and Term Two in 2023.

2.5 Data Analysis

H₀₃: Academic disidentification does not significantly mediate the relationship between achievement goals, perceived teacher support and mathematics achievement

The hypothesis was tested using multiple linear regression analysis. Baron and Kenny, (1986, as cited in Dastgeer et al., 2020) guided the mediation analysis.

Figure 2.1 Statistical mediation model. Adapted from Baron and Kenny (1986).

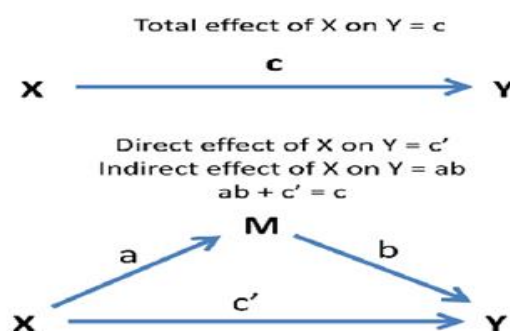

To further explore the null hypothesis, the researcher used path analysis.

3. RESULTS

To carry out the mediation test, the following conditions were tested; step 1: whether the independent variable in every hypothesis had a significant association with the dependent variable (i.e., mathematics achievement) (test path c); step 2: whether the independent variable had significant association with the mediator (i.e., academic disidentification) (test path a); step 3: whether the mediator variable had a significant association with the dependent variable (test path b). Step 4 involved

Achievement Goals, Perceived Teacher Support, and Mathematics Achievement: The Mediating Role of Academic Disidentification

establishing whether the mediating variable mediates the association between the independent and outcomes variables. Path c demonstrates the total effect. The effects of independent and mediator variables on the outcome variable were computed. Mediation effect is considered to be either full (effect is zero) or partial (effect decreases) (Celli, 2022).

Analysis of hypothesis was done in two parts. In part one, eight supplementary hypotheses affiliated to devaluing and in part two, eight supplementary hypotheses affiliated to discounting were advanced.

First, the descriptive statistics for academic disidentification were done.

Table 3.1 Descriptive Statistics for Academic Disidentification Subscales

Sub-dimension	Mean	SD	MD	Sk	Kur
Devaluing	19.25	1.86	2.05	-.29	.55
Discounting	17.30	1.14	3.29	-.37	-.60

Note. N = 418; SD = standard deviation; Kur = kurtosis; Sk = skewness.

Table 3.1 shows results on devaluing and discounting subscales of academic disidentification. Results for devaluing had a mean score of 19.25 and a standard deviation of 1.86. It was negatively skewed; -.29 with kurtosis of -.55. Negative skewness showed that most of the scores in relation to academic disidentification were above the mean. On the other hand, the mean score for discounting was 17.30 and standard deviation of 1.14. The scores had a negative skewness of -.37 and a positive kurtosis of -.60 as well.

A correlation test was then done and results presented in Table 3.2.

Table 3.2 Correlation Matrix for Academic Disidentification Subscales, Subscales of the Independent Variables and Mathematics Achievement

	Devaluing	Discounting	MA
Tap	-.26**	.33**	.23**
Sap	-.18**	-.29**	.27**
Oap	-.25**	-.30**	.26**
Tav	.33**	-.21**	-.37**
Sav	.35**	-.41**	-.36**
Oav	.24**	-.25**	-.44**
AuS	-.23**	-.20**	.39**
CoS	-.28**	-.23**	.39**
ReL	-.26	-.28	.26
MA	-.31**	-.36**	1

Note. ** = significant relationship

Note. Tap = Task approach goals; Sap = Self-approach goals; Oap = other approach goals; Tav = Task avoidance goals; Sav = Self-avoidance goals; Oav = other avoidance goals; AuS = Autonomy support; CoS = Competence support; ReL = Relatedness; MA = Mathematics achievement.

Table 3.2 indicates that all the variables were statistically significantly correlated except relatedness variable. Consequently, this variables was excluded from mediation analysis.

3.1 Hypothesis Testing

To conduct mediation analysis, the following null hypothesis was central:

H₀₃: Academic disidentification does not significantly mediate the relationship between achievement goals, perceived teacher support and mathematics achievement

Analysis of this hypothesis was done in two parts. In part one, eight supplementary hypotheses affiliated to devaluing and in part two, eight supplementary hypotheses affiliated to discounting were advanced.

a. Hypothesis for Devaluing

H03.1: Devaluing does not significantly mediate the relationship between Tap goals and mathematics achievement.

H03.2: Devaluing does not significantly mediate the relationship between Sap goals and mathematics achievement.

H03.3: Devaluing does not significantly mediate the relationship between Oap goals and mathematics achievement.

Achievement Goals, Perceived Teacher Support, and Mathematics Achievement: The Mediating Role of Academic Disidentification

H03.4: Devaluing does not significantly mediate the relationship between Tav and mathematics achievement.

H03.5: Devaluing does not significantly mediate the relationship between Sav and mathematics achievement.

H03.6: Devaluing does not significantly mediate the relationship between Oav and mathematics achievement.

H03.7: Devaluing does not significantly mediate the relationship between autonomy support and mathematics achievement.

H03.8: Devaluing does not significantly mediate the relationship between competence support and mathematics achievement.

In all the eight hypotheses, regression model of mediation analysis was done. The results are presented in Table 3.3.

Table 3.3 Regression Model of Mediation of Devaluing in the Relationship between Achievement Goals and Perceived Teacher Support Subscales and Mathematics Achievement

Hypothesis	Path	Beta (Unstandardized)	SE (Standardized)	Beta	r	F	p-value
1	c	1.05	1.38	.15	.23	16.22	.00
	a	.26	.03	.09	-.26	11.58	.00
	b	1.39	1.42	.14	-.31	18.30	.00
2	c	2.11	1.93	.13	.23	22.67	.00
	a	1.32	.54	.07	-.26	13.40	.00
	b	.87	1.25	.10	-.31	9.34	.00
3	c	2.70	2.03	.18	.26	14.30	.00
	a	1.41	.03	.11	-.25	10.98	.00
	b	.86	1.80	.12	-.31	15.44	.00
4	c	3.60	2.53	.16	-.44	19.26	.00
	a	1.43	1.06	.10	.24	16.13	.00
	b	1.76	2.38	.13	-.31	14.22	.00
5	c	2.06	2.95	.14	-.36	21.13	.00
	a	1.33	.07	.08	.35	16.74	.00
	b	1.96	1.36	.06	-.31	19.61	.00
6	c	1.88	2.41	.17	-.44	7.90	.00
	a	.35	.24	.11	.24	6.93	.00
	b	3.12	2.66	.12	-.31	4.15	.00
7	c	3.12	2.11	.09	.39	16.64	.00
	a	.65	.53	.06	-.23	13.78	.00
	b	1.40	1.42	.11	-.31	9.70	.00
8	c	2.76	2.11	.12	.34	20.65	.00
	a	.49	.55	.07	-.28	17.63	.00
	b	1.80	2.47	.10	-.31	8.91	.00

Note. SE = Standard error

Results in Table 3.3 reveal:

Hypothesis 1: An increase in devaluing was associated with a decrease in mathematics achievement. When controlling for devaluing, the beta value decreased from .15 to .09 showing evidence of partial mediation.

Achievement Goals, Perceived Teacher Support, and Mathematics Achievement: The Mediating Role of Academic Disidentification

Hypothesis 2: An increase in devaluing was associated with a decrease in mathematics achievement. When controlling for devaluing, the beta value decreased from .13 to .07 showing evidence of partial mediation.

Hypothesis 3: An increase in devaluing translated to a decrease in mathematics achievement. When controlling for devaluing, the beta value decreased from .18 to .11 showing evidence of devaluing being a partial mediator in the association between Oap goals and mathematics achievement.

Hypothesis 4: An increase in devaluing was attributed to a decrease in mathematics achievement. The results for controlling for devaluing showed a decrease in the beta value from .16 to .10. This was an evidence of devaluing partially mediating the association between Tav goals and mathematics achievement.

Hypothesis 5: An increase in devaluing was linked with a decrease in mathematics achievement. Controlling for devaluing also resulted in a decrease in the beta value from .14 to .08; showing evidence of that devaluing partially mediated the association between Sav goals and mathematics achievement.

Hypothesis 6: an increase in devaluing was attributable with a decline in mathematics achievement. When other devaluing was controlled for, the beta value decreased from .17 to .11, therefore, giving evidence that devaluing partially mediated the association between Oav goals and mathematics achievement.

Hypothesis 7: The outcome revealed that an increase in devaluing was attributed to a decrease in mathematics achievement. In addition, when devaluing was controlled for, a decrease in the beta value from .09 to .06 was noted. Thus, devaluing partially mediated the association between autonomy support and mathematics achievement.

Hypothesis 8: An increase in devaluing was linked to a decrease in mathematics achievement. When devaluing was controlled for, the beta value decreased from .12 to .07; confirming that devaluing partially mediated the association between competence support and mathematics achievement.

b. Hypotheses for Discounting

H03.1: Discounting does not significantly mediate the relationship between Tap goals and mathematics achievement.

H03.2: Discounting does not significantly mediate the relationship between Sap goals and mathematics achievement.

H03.3: Discounting does not significantly mediate the relationship between Oap goals and mathematics achievement.

H03.4: Discounting does not significantly mediate the relationship between Tav support and mathematics achievement.

H03.5: Discounting does not significantly mediate the relationship between Sav and mathematics achievement.

H03.6: Discounting does not significantly mediate the relationship between Oav and mathematics achievement.

H03.7: Discounting does not significantly mediate the relationship between autonomy support and mathematics achievement.

H03.8: Discounting does not significantly mediate the relationship between competence support and mathematics achievement.

Results for all the eight hypotheses are presented in Table 3.4.

Table 3.4 Regression Model of Mediation of Devaluing in the Relationship between AGs and Perceived Teacher Support Subscales and Mathematics Achievement

Hypothesis	Path	Beta (Unstandardized)	SE	Beta (Standardized)	r	F	p-value
1	c	3.12	2.40	.17	.23	19.16	.00
	a	.80	.90	.13	-.33	14.98	.00
	b	2.23	1.42	.16	-.36	11.23	.00
2	c	1.51	2.58	.20	.27	14.80	.00
	a	.59	.21	.13	-.29	12.63	.00
	b	2.67	2.30	.09	-.31	10.67	.00
3	c	1.37	3.31	.09	.26	10.24	.00
	a	1.62	1.21	.05	-.30	11.42	.00
	b	0.35	1.67	.06	-.31	12.11	.00

Achievement Goals, Perceived Teacher Support, and Mathematics Achievement: The Mediating Role of Academic Disidentification

4	c	3.62	2.46	.10	-.37	13.54	.00
	a	.68	.31	.08	-.21	9.02	.00
	b	2.67	1.22	.02	-.36	8.76	.00
5	c	3.15	2.68	.11	-.36	12.44	.00
	a	.52	.34	.07	-.41	9.67	.00
	b	2.56	1.40	.13	-.36	7.70	.00
6	c	2.01	3.61	.14	-.44	14.29	.00
	a	.44	.45	.09	-.25	13.58	.00
	b	2.56	.58	.11	-.36	12.36	.00
7	c	2.04	2.48	.16	.39	17.16	.00
	a	1.32	.48	.11	-.20	10.60	.00
	b	.37	1.34	.10	-.36	13.41	.00
8	c	1.64	1.38	.10	.39	22.28	.00
	a	.08	.05	.06	-.23	18.58	.00
	b	.27	2.59	.08	-.36	12.93	.00

Note. 418. SE = Standard error

Results in Table 3.4 reveal:

Hypothesis 1: An increase in discounting was associated with a decrease in mathematics achievement. When controlling for discounting, the beta value decreased from .17 to .13 showing evidence of partial mediation. Discounting, therefore, was a partial and significant mediator in the association between Tap goals and mathematics achievement.

Hypothesis 2: An increase in discounting was attributable to a decline in mathematics achievement. When controlling for discounting, the beta value decreased from .20 to .13 showing evidence of partial mediation.

Hypothesis 3: An increase in discounting translated to a decrease in mathematics achievement. Whilst controlling for discounting, the beta value decreased from .09 to .05 showing evidence of partial mediation in the association between Oap goals and mathematics achievement.

Hypothesis 4: An increase in discounting was attributed to a decrease in mathematics achievement. The results for controlling for discounting showed a decrease in the beta value from .10 to .08. This was an evidence of discounting partially mediating the link between Tav goals and mathematics achievement.

Hypothesis 5: An increase in discounting was attributable to decline in mathematics achievement. Controlling for discounting also resulted in a decrease in the beta value from .11 to .07; showing evidence of that discounting partially mediated the association between Sav goals and mathematics achievement.

Hypothesis 6: The results pointed out that an increase in discounting was attributable to a decline in mathematics achievement. When discounting was controlled for, the beta value decreased from .14 to .09, therefore, giving evidence that discounting partially mediated the association between Oav goals and mathematics achievement.

Hypothesis 7: The outcome revealed that an increase in discounting was attributed to a decrease in mathematics achievement. In addition, when discounting was controlled for, a decrease in the beta value from .16 to .11 was noted. Thus, discounting partially mediated the association between autonomy support and mathematics achievement.

Hypothesis 8: An increase in discounting was linked to a decrease in mathematics achievement. When discounting was controlled for, the beta value decreased from .10 to .06; confirming that discounting partially mediated the relationship between competence support and mathematics achievement.

3.2 Path Analyses

Path analysis was used to test the overall conceptual framework advanced in the study. On this premise, path analysis sought to: a) estimate the path loadings of the independent (exogenous) variables on the dependent (endogenous) variable; b) show relationships between the variables based on a priori model; c) show the indirect effects of exogenous variables on the endogenous variable. The proposed model investigating whether academic disidentification mediated the relationship between

Achievement Goals, Perceived Teacher Support, and Mathematics Achievement: The Mediating Role of Academic Disidentification

the achievement goals, perceived teacher support and mathematics achievement. Using Amos version 26 software; a general structural model was developed and results presented in Figure 3.1.

Figure 3.1 Reduced Structural Model 1

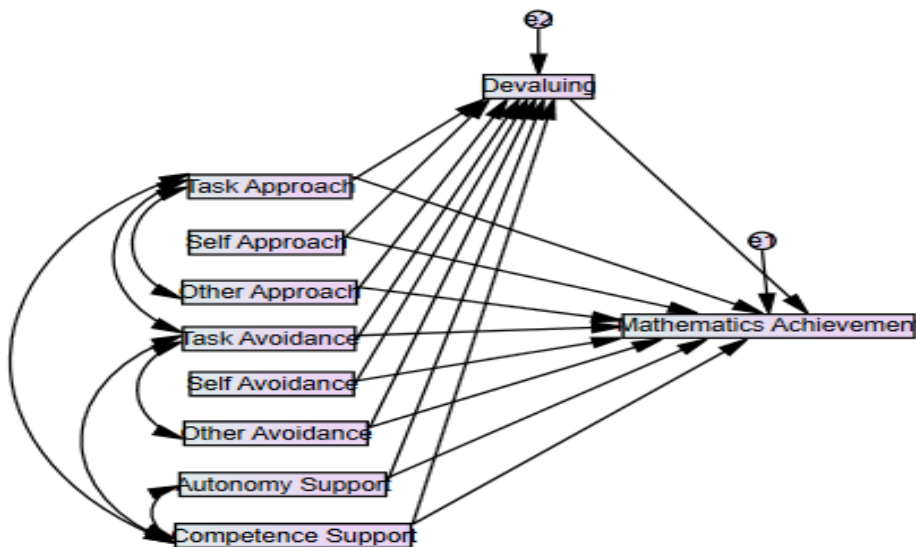

Estimates for the direct paths from Tap, Sap, Oap, autonomy and competence support through devaluing to mathematics achievement were negative and significant ($\beta = -.26, -.28, -.25, -.23, -.20, p < .05$ respectively). Conversely, estimates for the direct paths from Tav, Sav, and Oav goals to devaluing were positive and significant ($\beta = .25, .22, .24, p < .05$ respectively). The path from devaluing to mathematics achievement was negative and significant ($\beta = -.21, p < .05$). Therefore, Figure 3.1 demonstrates that the paths for Tap, Sap, Oap, autonomy, competence support and devaluing were negative and significant predictors of mathematics achievement while the paths for Tav, Sav, and Oav to devaluing were positive and significant predictor of poor mathematics achievement. Additionally, devaluing was a negative and significant predictor of mathematics achievement. As pointed out by Harris & Gleason (2022) direct effects show how 1 unit change in an independent variable will affects the outcome variable holding all other variables constant. Indirect effects for mathematics achievement through devaluing were determined and results are given in Table 3.5.

Table 3.5 Indirect Effects for Mathematics Achievement through Devaluing

Predictors	Path a		Path b		Path c		IE	95% Boot CI	
	β	p	β	p	β	p		LL	UL
Task approach (p1)	-.26	.00	-.21	.00	.23	.00	.04	.33	.45
Self-approach (p2)	-.28	.00	-.21	.00	.23	.00	.03	.08	.12
Other approach (p3)	-.25	.00	-.21	.00	.18	.00	.04	.12	.20
Task avoidance (p4)	.25	.00	-.21	.00	-.20	.00	-.03	.11	.25
Self-avoidance (p5)	.22	.00	-.21	.00	-.24	.00	-.04	.09	.12
Other avoidance (p6)	.24	.00	-.21	.00	-.19	.00	-.03	.10	.18
Autonomy support (p7)	-.23	.00	-.21	.00	.26	.00	.04	.06	.13
Competence (p8)	-.20	.00	-.21	.00	.22	.00	.04	.10	.25

Note. P = path; IE=Indirect effects, CI=Confidence interval, LL=Lower Limit, UL=Upper Limit

The indirect effects of task based goals, self-based, approach based, avoidance based, autonomy, and competence on mathematics achievement through devaluing were determined and statistical significance assessed. The results revealed that the indirect effects of Tap goals to mathematics achievement was .04. The effect was found to be statistically significant ($p < .05$). Other indirect effects include Sap, Oap, Tav, Sav, Oav goals, autonomy and competence support (.03, .04, -.03, -.04, -.03, .04, and .04; $p < .05$) respectively. From the findings, the indirect effects were statistically significant.

Results for reduced model 2 are presented in Figure 3.2.

Achievement Goals, Perceived Teacher Support, and Mathematics Achievement: The Mediating Role of Academic Disidentification

Figure 11 Reduced Structural Model 2

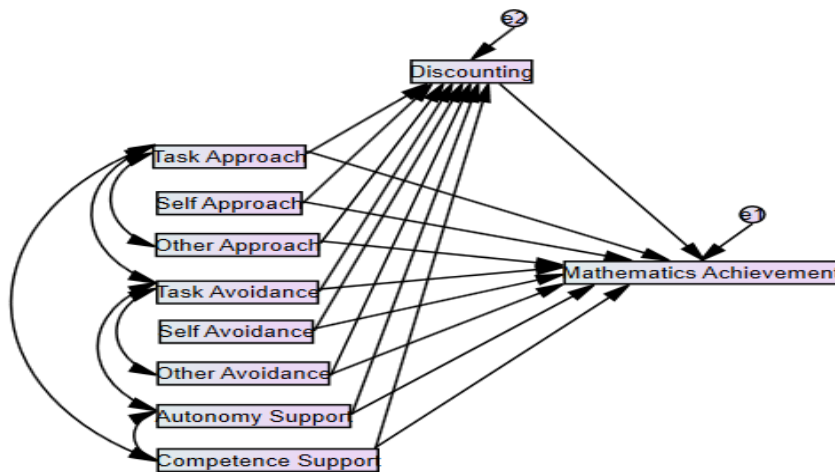

Similarly, estimates for the direct paths from Tap, Sap goals, Oap, autonomy and competence support through discounting to mathematics achievement were estimated. Results demonstrated that the estimates for task approach, self-approach, other approach, autonomy, and competence paths to discounting were negative and significant ($\beta = -.20, -.29, -.18, -.20, -.23; p < .05$) respectively while positive and significant for Tav, Sav, and Oav goals ($\beta = .21, .19, .22; p < .05$) respectively. The path from discounting to mathematics achievement was negative and significant ($\beta = -.22, p < .05$). Results in Table 3.5 affirms that the paths for Tap, Sap, Oap, autonomy, competence support to discounting were negatively associated and significant predictors of mathematics achievement while the paths for Tav, Sav and Oav goals to discounting were positive and significantly predicted mathematics achievement. Further, the indirect effects for mathematics achievement through discounting were determined and results were presented in Table 3.6.

Table 3.6. Indirect Effects for Mathematics Achievement through Discounting

Predictors	Path a		Path b		Path c		IE	95% Boot CI	
	β	p	β	p	β	p		LL	UL
Tap (p1)	-.20	.00	-.22	.00	.23	.00	.04	.12	.18
Sap (p2)	-.29	.00	-.22	.00	.27	.00	.04	.34	.39
Oap (p3)	-.18	.00	-.22	.00	.26	.00	.03	.25	.33
Tav (p4)	.21	.00	-.22	.00	-.27	.00	-.04	.17	.26
Sav (p5)	.19	.00	-.22	.00	-.26	.00	-.04	.13	.19
Oav (p6)	.22	.00	-.22	.00	-.21	.00	-.03	.10	.17
Autonomy support (p7)	-.20	.00	-.22	.00	.29	.00	.04	.03	.19
Competence (p8)	-.23	.00	-.22	.00	.26	.00	.04	.17	.23

Note. P = Path, IE=Indirect effects, CI=Confidence interval, LL=Lower Limit, UL=Upper Limit

Results from Table 3.6 demonstrates the indirect effect estimates of the independent variables on the outcome variable. The estimates for Tap, Sap, Oap, Tav, Sav, Oav goals, autonomy and competence support are (.04, .04, .03, -.04, -.04, -.03, .04, and .04; $p < .05$) respectively. It was established, therefore, that the indirect effects of the independent variables on the outcome variable were significant and associated with mathematics achievement.

4. DISCUSSION OF THE RESULTS

Premised on the tenets of the expectancy - value theory, motivation to perform well in mathematics is dependent on two components that include expectations and value linked to the mathematics task. The emphasis of this study was largely on the task value facet. Task value was operationalized as the motivation to engage in solving mathematics problems. Task value was characterized by four attributes - attainment value, the intrinsic value, cost, as well as the utility value. Students who believed they can solve certain mathematics tasks were more likely to find their achievement goals and teacher support aligned to their motivation of solving mathematics problems. Based on these findings, the study established that the two subscales of

Achievement Goals, Perceived Teacher Support, and Mathematics Achievement: The Mediating Role of Academic Disidentification

disidentifying with mathematics – devaluing and discounting mediated the association between achievement goals and perceived teacher support subscales and mathematics achievement.

The path results affirmed prior findings that achievement goals, perceived teacher support, academic achievement predicts mathematics achievement. Importantly, through path analyses, the indirect effects of task based, self-based, approach based, avoidance-based goals, and autonomy and competence support on mathematics achievement through devaluing and discounting were statistically significant. Therefore, the indirect effect of the independent variables on the outcome variable also predicts mathematics achievement.

Disidentification, ego withdrawal from a domain and its standards, was found to result in a student exhibiting depleted ego on the pursuit of mathematics and may resist any encouragement either intrinsically or extrinsically to develop one. Domain disidentification illuminates a more permanent separation of the self and the mathematics domain whose outcome is suboptimal achievement in mathematics. Domain disidentification is a dynamic process. Prior studies are in agreement that continued disidentification impairs achievement (Ferd, 2016). In line with this, the study established that devaluing and discounting distances ego from a valued domain. As a result, students disidentified with mathematics are more likely to post poor mathematics achievement outcomes.

5. CONCLUSION AND RECOMMENDATIONS FOR FURTHER RESEARCH

Either process, discounting and devaluing, allows learners to psychologically distance themselves from pursuing their achievement goals and realizing the role of teacher support in developing their autonomy and competence consequently resulting poor mathematics achievement. Indeed, mathematics achievement requires strong identification with the subject, setting achievement goals and embracing the scaffolding role of mathematics teachers. The study concluded that avoidance valence goals are rarely related to positive mathematics outcomes (i.e., largely, a negative impact of avoidance motivation with mathematics achievement was reported), whereas approach valence goals had a positive association with mathematics achievement outcomes. These findings augment knowledge that ego attachment plays a crucial role in students' mathematics learning process. The findings of the current study can be linked to two plausible reasons. First, students' achievement goals would be affected by student individual reasons assigned to engaging in solving mathematics problems. Students focus may go high or decline in solving mathematics tasks depending on whether they are approach or avoidance based. Secondly, how students view the role of teacher support impact the overall achievement in mathematics.

Recommendations for further research: Whether the effect of devaluing and discounting on students' mathematics achievement is consistent across student subgroups and how background differences may influence the association was not within the scope of this study. Further studies are therefore recommended.

REFERENCES

- 1) Balva, D., Page, D. T., Collardeau, F., Gómez Henao, J. A., & Flores-Camacho, A. L. (2022). International Capacity Building in Psychological Science: Reflections on Student Involvement and Endeavors. *Trends in Psychology*, 1–28. Advance online publication. <https://doi.org/10.1007/s43076-022-00168-5>
- 2) Belmont M., Skinner E., Wellborn J., & Connell J. (1992). *Teacher as Social Context: A measure of student perceptions of teacher provision of involvement, structure, and autonomy support* (Technical report). Rochester, NY: University of Rochester.
- 3) Brockbank, R. D. (2021). How the Interaction of Domain and Situational Achievement Goals Influences Task Performance (Doctoral dissertation, Durham University). <http://etheses.dur.ac.uk/14271/1/Thesis.pdf>
- 4) Carvalho, C., Santos, N. N., António, R., & Martins, D. S. M. (2021). Supporting students' engagement with teachers' feedback: The role of students' school identification. *Educational Psychology*, 41(7), 863-882.
- 5) Celli, V. (2022). Causal mediation analysis in economics: Objectives, assumptions, models. *Journal of Economic Surveys*, 36(1), 214-234. <https://onlinelibrary.wiley.com/doi/pdfdirect/10.1111/joes.12452>
- 6) Creswell, J.W. (2018). *Educational research: Planning, conducting, and evaluating quantitative and qualitative research* (5th ed.). Thousand Oaks.
- 7) Dastgeer, G., Rehman, A., & Asghar, M. A. (2020). Selection and use of mediation testing methods; application in management sciences. *Business & Economic Review*, 12(3), 73-96. <http://bereview.pk/index.php/BER/article/view/352>
- 8) Elliot, A. J., Murayama, K., & Pekrun, R. (2011). A 3 × 2 achievement goal model. *Journal of Educational Psychology*, 103, 632–648. doi:10.1037/a0023952

Achievement Goals, Perceived Teacher Support, and Mathematics Achievement: The Mediating Role of Academic Disidentification

- 9) Elliot, A. J., Murayama, K., & Pekrun, R. (2011). A 3 x 2 achievement goal model. *Journal of Educational Psychology*, 103(3), 632-648. <https://doi.org/10.1037/a0023952>
- 10) Fowler, S. B., & Lapp, V. (2019). Sample size in quantitative research: Sample size will affect the significance of your research. *American Nurse Today*, 14(5), 61-63. <http://www.americannursetoday.com/about-us/>
- 11) Gill, J., Johnson, P., & Clark, M. (2010). *Research Methods for Managers*. (4th ed.), SAGE Publications. <https://books.google.co.ke/books?>
- 12) Guay, F. (2022). Applying self-determination theory to education: Regulations types, psychological needs, and autonomy supporting behaviors. *Canadian Journal of School Psychology*, 37(1), 75-92. <https://doi.org/10.1371/journal.pone.0256558>
- 13) Hulleman, C. S., Durik, A. M., Schweigert, S. A., & Harackiewicz, J. M. (2008). Task values, achievement goals, and interest: An integrative analysis. *Journal of Educational Psychology*, 100(2), 398-416. <https://doi.org/10.1037/0022-0663.100.2.398>
- 14) Hunsu, N. J., Olaogun, O. P., Oje, A. V., Carnell, P. H., & Morkos, B. (2023). Investigating students' motivational goals and self-efficacy and task beliefs in relationship to course attendance and prior knowledge in an undergraduate statics course. *Journal of Engineering Education*, 112(1), 108-124. <https://doi.org/10.1002/jee.20500>
- 15) Ireri, A. M. (2015). *Academic identity status and achievement goal orientation as predictors of academic achievement among form three students in Embu County, Kenya*. Unpublished doctoral dissertation, Kenyatta University, Nairobi, Kenya. <https://ir-library.ku.ac.ke/items/69d10a13-9b27-4fbd-98ac-6d4012628a9f>
- 16) Ireri, A. M., Wawire, C. K., Mugambi, D. K., & Mwangi, C.N. (2015). Academic identity status measure: Psychometric properties when used among secondary school students in Kenya. *International Journal of School and Cognitive Psychology*, 2(4), 150. <https://doi.org/10.4172/2469-9837.1000150>
- 17) Ireri, A. M.; Mwangi, C. N., Mwaniki, E. W. & Wambugu, S. K. (2021). Achievement goal orientations as predictors of academic achievement among secondary school students in Embu County, Kenya. *International Journal of School and Cognitive Psychology*, DOI: 10.35248/2329-8901.19.7.215.
- 18) Israel, G. D. (2020). Sampling the evidence of extension program impact. *EDIS*, 2016(1), 9-9. <https://www.tandfonline.com/doi/pdf/10.1080/23311932.2023.2263952>
- 19) Just, J., & Siller, H-S (2022). The role of mathematics in STEM secondary classrooms: A systematic literature review. *Education Sciences*, 12(9):629. <https://doi.org/10.3390/educsci12090629>
- 20) Kenya National Examinations Council, (KNEC). (2022). The 2018 Kenya Certificate of Secondary Education (KCSE) examination essential statistics. Nairobi, Kenya. Author
- 21) Kim, J. Y., & Meister, A. (2023). Microaggressions, interrupted: The experience and effects of gender microaggressions for women in STEM. *Journal of Business Ethics*, 185(3), 513-531. <https://link.springer.com/article/10.1007/s10551-022-05203-0>
- 22) Li, H., Zhang, M., Hou, S., Huang, B., Xu, C., Li, Z., & Si, J. (2023). Examining the dynamic links among perceived teacher support, mathematics learning engagement, and dimensions of mathematics anxiety in elementary school students: A four-wave longitudinal study. *Contemporary Educational Psychology*, 75, 1-11. <https://doi.org/10.1016/j.cedpsych.2023.102211>
- 23) Loose, F., Régner, I., Morin, A. J., & Dumas, F. (2012). Are academic discounting and devaluing double-edged swords? Their relations to global self-esteem, achievement goals, and performance among stigmatized students. *Journal of Educational Psychology*, 104(3), 713.
- 24) Major, B., Spencer, S., Schmader, T., Wolfe, C., & Crocker, J. (1998). Coping with negative stereotypes about intellectual performance: The role of psychological disengagement. *Personality and Social Psychology Bulletin*, 24, 34-50. doi: 10.1177/0146167298241003
- 25) Mazana, M. Y., Montero, C. S., & Casmir, R. O. (2020). Assessing students' performance in mathematics in Tanzania: the teacher's perspective. *International Electronic Journal of Mathematics Education*, 15(3), em0589. <https://doi.org/10.29333/iejme/7994>
- 26) McClain, S., & Cokley, K. (2017). Academic disidentification in Black college students: The role of teacher trust and gender. *Cultural Diversity & Ethnic Minority Psychology*, 23(1), 125-133. <https://doi.org/10.1037/cdp0000094>
- 27) McKenna, J. (2023). *What STEM Can Do for Your Classroom: Improving Student Problem Solving, Collaboration, and Engagement, Grades K-6 (Supplement your teaching with field-tested strategies.)*. Solution Tree Press.

Achievement Goals, Perceived Teacher Support, and Mathematics Achievement: The Mediating Role of Academic Disidentification

- 28) Miller, A. L. (2022). Achievement Goal Orientation as a Predictor of High-Impact Practice Participation for Postsecondary Students. *Mid-Western Educational Researcher*, 34(3).
<https://www.mwera.org/mwer/volumes/v34/issue3/mwer-v34n3-miller-distinguished-paper.pdf>
- 29) Möller, J. (2024). Ten years of dimensional comparison theory: On the development of a theory from educational psychology. *Educational Psychology Review*, 36(3), Article 82. <https://doi.org/10.1007/s10648-024-09918-6>
- 30) Namkung, J. M., Peng, P., & Lin, X. (2019). The relation between mathematics anxiety and mathematics performance among school-aged students: A meta-analysis. *Review of Educational Research*, 89(3), 459-496.
<https://journals.sagepub.com/doi/abs/10.3102/0034654319843494>
- 31) Ncororo, M. R., Koinange, C. W. & Ileri, A. M. (2022). Task value as a predictor of academic achievement among form three students in Meru County, Kenya. *International Journal of Education and Research*, 10(4), 15-24.
- 32) Ndyareeba, E., Biirah, J. & Kibedi, H. K. (2024). Achievement of Goal Orientation and Academic Engagement among Adolescents in Southwestern Uganda. *East African Journal of Education Studies*, 7(2), 1-18.
<https://doi.org/10.37284/eajes.7.2.1848>.
- 33) Nufus, H., Muhandaz, R., Hasanuddin, Nurdin, E., Ariawan, R., Fineldi, R. J., Hayati, I. R., & Situmorang, D. D. B. (2024). Analyzing the students' mathematical creative thinking ability in terms of self-regulated learning: How do we find what we are looking for?. *Heliyon*, 10(3), e24871. <https://doi.org/10.1016/j.heliyon.2024.e24871>
- 34) Osborne, J. W., & Jones, B. D. (2011). Identification with academics and motivation to achieve in school: How the structure of the self-influences academic outcomes. *Educational Psychology Review*, 23, 131-158.
- 35) Pulkka, A. T., & Budlong, L. (2022). Associations Between Achievement Goal Orientations, Preferred Learning Practices, and Motivational Evaluations of Learning Environment Among Finnish Military Reservists. *Frontiers in psychology*, 13, 902478. <https://doi.org/10.3389/fpsyg.2022.902478>
- 36) Puthillam, A., Montilla Doble, L. J., Delos Santos, J. J. I., Elsherif, M. M., Steltenpohl, C. N., Moreau, D., Pownall, M., Silverstein, P., Anand-Vembar, S., & Kapoor, H. (2024). Guidelines to improve internationalization in the psychological sciences. *Social and Personality Psychology Compass*, 18(1), Article e12847. <https://doi.org/10.1111/spc3.12847>
- 37) Radišić, J., Krstić, K., Blažanin, B., Mičić, K., Baucal, A., Peixoto, F., & Schukajlow, S. (2024). Am I a math person? Linking math identity with students' motivation for mathematics and achievement. *European Journal of Psychology of Education*, 1-24.
- 38) Ryan, R. M., & Deci, E. L. (2000). Self-determination theory and the facilitation of intrinsic motivation, social development, and well-being. *American Psychologist*, 55, 68-78. <https://doi.org/10.1037/0003-066X.55.1.68>
- 39) Shaughnessy, M. (2013). Mathematics in a STEM context. *Mathematics Teaching in the Middle School*, 18(6), 324.
- 40) Simamora, B., & Mutiarawati, E. V. (2021). Achievement Goals Model Validation: Is the 2X2 Better than the Trichotomous? *International Journal of Evaluation and Research in Education*, 10(1), 142-149.
<https://files.eric.ed.gov/fulltext/EJ1285481.pdf>
- 41) Steele, C. M. (1997). A threat in the air: How stereotypes shape intellectual identity and performance. *American Psychologist*, 52, 613-629. doi:10.1037/0003-066X.52.6.613
- 42) Suherman, S. & Vidákovich, T. (2022). Assessment of mathematical creative thinking: A systematic review. *Thinking Skills and Creativity*, 44, 101019. <https://doi.org/10.1016/j.tsc.2022.101019>.
- 43) Tuominen, H., Juntunen, H., & Niemivirta, M. (2020). Striving for success but at what cost? Subject-specific achievement goal orientation profiles, perceived cost, and academic well-being. *Frontiers in Psychology*, 11, Article 557445. <https://doi.org/10.3389/fpsyg.2020.557445>
- 44) Vergara, C.R. (2021) Mathematics Resilience and Achievement Goals: Exploring the Role of Non-Cognitive Factors to Mathematics Performance of University Students amidst of Pandemic. *Open Access Library Journal*, 8, 1-10. doi: [10.4236/oalib.1108166](https://doi.org/10.4236/oalib.1108166).
- 45) Wang, C., Xu, Q., & Fei, W. Q. (2024). The effect of student-perceived teacher support on math anxiety: chain mediation of teacher-student relationship and math self-efficacy. *Frontiers in Psychology*, 15, 1333012. <https://doi.org/10.3389/fpsyg.2024.1333012>
- 46) Wang, T., Zhang, L., Xie, Z., & Liu, J. (2023). How does mathematical modeling competency affect the creativity of middle school students? The roles of curiosity and guided inquiry teaching. *Frontiers in Psychology*, 13, 1044580. <https://doi.org/10.3389/fpsyg.2022.1044580>

Achievement Goals, Perceived Teacher Support, and Mathematics Achievement: The Mediating Role of Academic Disidentification

- 47) Werunga, S. N. & Odera, P. (2022). Achievement Goals as Predictors of Academic Performance of Primary School Pupils in Migori County, Kenya. *IOSR Journal of Humanities and Social Science (IOSR-JHSS)*, 27(3), 25-34. DOI: 10.9790/0837-2703052534
- 48) Wrigley-Asante, C., Ackah, C. G., & Frimpong, L. K. (2023). Gender differences in academic performance of students studying Science Technology Engineering and Mathematics (STEM) subjects at the University of Ghana. *SN social sciences*, 3(1), 12. <https://doi.org/10.1007/s43545-023-00608-8>
- 49) Wu C. C. (2023). Effects of achievement goals on learning interests and mathematics performances for kindergarteners. *Frontiers in psychology*, 14, 1156098. <https://doi.org/10.3389/fpsyg.2023.1156098>
- 50) Yildirim, Y., & Yilmaz, Y. (2023). Promoting creativity in early childhood education. *PLoS one*, 18(12), e0294915. <https://doi.org/10.1371/journal.pone.0294915>
- 51) You, J. W. (2021). Investigating the effects of achievement goals on team creativity and team achievement in learning communities at a South Korean university. *Higher Education*, 81(2), 367-383. <https://link.springer.com/article/10.1007/s10734-020-00545-y>
- 52) Zhong, J., Wen, J., & Li, K. (2023). Do achievement goals differently orient students' academic engagement through learning strategy and academic self-efficacy and vary by grade. *Psychology research and behavior management*, 16, 4779–4797. <https://doi.org/10.2147/PRBM.S424593>
- 53) Zhou, P., Sun, W., Zhou, Y., & Li, T. (2024). Teacher support promotes the classroom engagement of mathematically poor students: a moderated mediation model. *Educational Psychology*, 1–20. <https://doi.org/10.1080/01443410.2024.2405150>



There is an Open Access article, distributed under the term of the Creative Commons Attribution – Non Commercial 4.0 International (CC BY-NC 4.0) (<https://creativecommons.org/licenses/by-nc/4.0/>), which permits remixing, adapting and building upon the work for non-commercial use, provided the original work is properly cited.

Foreign Finance, FDI-Climate Interaction and Economic Development in Ethiopia: A Time Series Analysis



Muhammad Ali¹, Salam S. Mohammed¹, Kazeem O. Isah¹, Ozovehe Abdulsalami²

¹Department of Economics, Faculty of Social Sciences, Prince Abubakar Audu University (PAAU), Anyigba, Kogi State, Nigeria

²Department of Economics, Faculty of Social Sciences, University of Abuja, Abuja, Nigeria.

ABSTRACT: Developing countries such as Ethiopia, over the years particularly after the cold war, starting from early 1990s have adopted neoliberal policies through reforms to attract foreign finance for development needs in view of inadequacy of domestic capital for public and private investment. However, despite the inflow of foreign capital into the economy, it is still grappling with major development challenges. It is in view of this that this study examines the impact of foreign finance on the economy, and whether FDI-climate interaction limits the potential impact of foreign direct investment (FDI) as an important component of foreign capital, on economic development in Ethiopia. The study further reveals the implications of post-cold war adoption of market-oriented policies in Ethiopia. The study uses autoregressive distributed lag (ARDL) model with data spanning from 1981 to 2020. It is found that FDI has positive and significant impact on economic development in the long run, but the positive effect is revealed to be insignificant in the short run. On the other hand, foreign debt is revealed to have long term negative though insignificant impact on economic development of the country. Furthermore, it is revealed that FDI-climate interaction has negative implication on the economy in both the long run and short run. Therefore, the effectiveness and efficiency of foreign finance on growth and development outcome in Ethiopia is conditional on whether it produces long run sustainable environmental outcome. Also, the adoption of neoliberal policies has not resulted in development of Ethiopia. Hence, the study recommends among others, the need for consideration of absorptive capacity of the country as a recipient economy and in its reforms, as well as the need for the government and development partners to ensure assessment of the long run potential environmental impact of foreign capital before they are deployed on the economy.

KEYWORDS: Foreign Finance, FDI-Climate Interaction, Economic Development

INTRODUCTION

Developing countries' prime area of policy objective has been the attainment of high and sustainable economic growth and development. Yet, to achieve this, policy makers have had to grapple with understanding the drivers of economic prosperity part of which has been identified to be foreign finance (Terefe, 2018). Thus, development thinking from the mid-twentieth century has prescribed foreign capital as a panacea for driving economic growth of developing countries in view of their inherent challenge of insufficient domestic capital to finance development needs (Wako, 2017; Girma and Tilahun, 2022; Tadesse, 2011). Therefore, external capital has been recognized as one of the avenues through which low-income economies can enhance growth and development (Adedokun, 2017). This has necessitated reforms in the developing world especially after the cold war and adoption of neoliberal policies part of which is opening up of the economies in order to attract foreign capital.

Ethiopia in particular, which was much tilted towards socialism in its early years as a country started having neoliberal leaning, and embracing of free market economic system particularly in the early 1990s after the implosion of the socialist military government. This was championed by Ethiopian People's Revolutionary Democratic Front (EPRDF). It adopted market-oriented structural and institutional reforms as a precondition for inflow of external capital and credit to engender recovery of the Ethiopian economy which was stagnated in the 1970s and 1980s (Demissie, 2008). This is not to rule out the fact that there has been interventionist economic model to stabilize the new ideological disposition of the economy, but the market system became a more visible trajectory of economic management system in the country. However, scholars have argued that neo-liberalism has not helped in solving socio-economic and geo-political problems of Ethiopia, because in particular, the structural adjustment

Foreign Finance, FDI-Climate Interaction and Economic Development in Ethiopia: A Time Series Analysis

program (SAP), a pro-market policy that was adopted in the country, was designed by industrialized countries having neo-liberalism perspectives without appreciation of the uniqueness of the economy of Ethiopia and the inherent cultural idiosyncrasy of the people (Demissie, 2008; Mekuria, 2021). This has had implications on the gains from foreign finance.

Deriving from the foregoing, Adebayo and Kalmaz (2020), Duresa (2022) and Terefe (2018) have explained the obvious realities of most developing economies that necessitates the need for foreign finance in terms of challenges of three resource gaps faced by them. First, there is saving gap which hampers the realization of desired investment and appears in the form of excess supply of labour constrained by limited capital. Second, there is foreign exchange gap thus earnings from foreign exchange through exports are not enough to fund the importation of capital goods for investment purposes. Duresa (2022) explained that Ethiopia's dependence on export of limited primary agricultural products such as coffee makes it to be exposed to the challenge of foreign exchange gap. Third, developing countries suffer from fiscal gap as their government revenue is not adequate to finance domestic projects and achieve targeted investment and growth. Therefore, foreign finance becomes important to fill these gaps in order to foster economic growth and development. In countries like Ethiopia where there is considerable resource gap, the flow of foreign capital must fill the aforementioned gaps (Terefe, 2018).

However, what appears not to have been captured in the literature and that requires urgent attention is the environmental sustainability gap (the fourth gap). The inclusion of environmental gap is germane in view of the current experiences of climate change in the developing world and its attendant consequences. Foreign finance is needed to close the gap between the current realities of African environmental challenges (climate change) and what is required as sustainable environment. On the contrary, apart from industrial activities in developed countries, the literatures have pointed out that foreign capital inflow, especially foreign direct investment (FDI) has proven to pose environmental threats due to their greenhouse gasses (GHGs) emission resulting in climate change and associated developmental challenges in the continent (see Opoku and Boachie, 2020; Ahmed et al., 2022; and Ali, 2022). Foreign capital could have exacerbated the magnitude of GHGs and particularly carbon (CO₂) emission in the continent and indeed Ethiopia, judging from the fact that Africa has not evolved considerably in the areas of climate policies hence it could be that the continent (and Ethiopia in particular) is attractive to foreign finance inflow from companies that seek to avoid the identified competitive disadvantages related to stringent environmental regulations in their locality. Considering Ethiopia, being dominated by rural society with more than 70 percent of the total population living in rural areas; with high incidence of poverty and being one of the poorest countries in the globe; with an economy that is very subsistence relying on agriculture, which depends on and is vulnerable to climate conditions (Duresa, 2022), foreign finance should enhance environmental sustainability by mitigating its degradation, and improving on adaptation to, instead of exacerbating climate change through GHGs, and in particular, carbon emissions.

Nonetheless, the need for external capital in developing economies is very important and explains why policies are being made to attract it into these economies, and different development partners are embracing policies that will increase the level of foreign capital, particularly aid inflow to less developed countries (LDCs). For instance, in 1970s, developed countries came to agreement to dedicate 0.7 percent of their gross national income (GNI) annually for official international development, though they rarely meet up with it. However, countries in sub-Saharan Africa (SSA) have been recipients of foreign development finance for decades, and other forms of foreign capital, but still remain as one of the poor regions of the world (Adedokun, 2017). Thus, foreign finance has been blamed to be one of the factors responsible for Africa's underdevelopment – it is explained to be the malady to which it pretends to be the cure (Moyo, 2009). This is because the expectation is that if external capital should be the panacea for development, SSA should have recorded significant advancement over the years given the magnitude of foreign finance inflow into the economies (Adedokun, 2017). The non-performance of foreign finance as witnessed in the economic realities of developing nations that have received a substantial amount of it has led to questions about whether it is a valuable and effective strategy for triggering GDP growth and development in the beneficiary nations (Adebayo and Kalmaz, 2020). In particular, despite Ethiopia's abundant human and material resources, and its receipt of foreign capital over the years, it is still classified as a developing economy. The country has received a reasonable level of foreign capital/aid yet it still ranks among the poor countries of the world. The debate has been that the negative or limited effectiveness of foreign capital on growth in developing countries has been due to governance challenges, weak institutions and insufficiency of human capital. This study adds environmental challenges posed by foreign finance (FDI in particular) as one of the reasons for the limited effectiveness of foreign capital on development.

Although economic theory suggests that foreign capital flows should enhance economic growth and development as it contributes to host country's capital accumulation, result in technological diffusion, and brings about improvement in techniques of management and productivity spillovers (Agbloyor et al., 2016). However, in spite of this theoretical backing for foreign finance, the empirical literatures have produced largely mixed and inconclusive findings. The explanations for this have been attributed to the peculiar characteristics of recipient economies. Agbloyor et al. (2016) explained that it is evident that foreign capital flows

Foreign Finance, FDI-Climate Interaction and Economic Development in Ethiopia: A Time Series Analysis

promote growth and development only under certain conditions which include sufficiency of human capital, trade liberalization, stable economy, adequate infrastructure, strong institutions, level of financial development, and good governance. All these determine the extent of realization of benefits from foreign capital inflows. The realizable benefits depend on the recipient economy's absorptive capacity. Nevertheless, a number of studies have revealed widespread failure of foreign capital in developing countries particularly in sub-Saharan Africa (SSA). These studies include Agbloyor et al. (2016), Adedokun (2017), and Wako (2017). However, there are also works that have revealed external finance inflow to have positive impact, for instance, Zuniga (2011), Tadesse (2011), and Girma and Tilahun (2022). Studies that revealed negative impact of external capital (particular aid) on economic growth have blamed some factors to be responsible for the failure of external finance. Some researchers have hinged the failure of foreign finance on policy and institutions (Zuniga, 2011; Agbloyor et al., 2016; Wako, 2017; and Terefe, 2018). Others have blamed limited human capital in recipient countries (Su and Nguyen, 2020; and Mohd and Muse, 2021). The research conducted by Adedokun (2017) explained that governance and foreign finance complementarity have implications on growth enhancement of foreign capital.

On the whole, researchers that found external capital (especially foreign aid) to be growth and development enhancing are of the opinion that it augments savings, finances investments and increases productivity. In contrast, a general consensus of the studies that found external finance to have negative implications on growth and development advanced some reasons to be responsible. The reasons given among others include misuse of aid (aid fungibility), corruption, maladministration, tying up of aid with precious resources in recipient countries, crowding out effect of external finance on the private sector, discouragement of savings, weak institutions and policy environment, insufficient level of human capital and aid disbursement volatility (Adedokun, 2017).

Apart from the foregoing factors established in the existing literature to have contributed to failure or limited socioeconomic effectiveness of external capital, this study argues that the potential impact of foreign finance on economic growth in sub-Saharan Africa and particularly in Ethiopia is likely to be undermined by the impact of foreign capital (FDI in particular) on environment/climate change. This is in view of the fact that foreign finance (FDI) is established to result in the emission of greenhouse gasses that pose threats to the environment thereby further having negative implications on livelihoods (Ahmed et al., 2022; and Ali, 2022; Opoku and Boachie, 2020). The livelihood is affected by climate change particularly in African countries due to the dependence of the nations in the continent on economic activities that are closely linked to nature hence are vulnerable to climatic changes, and the fact that Africa has limited adaptive capacity. Therefore, foreign finance (FDI) inflow interaction with the Ethiopia's environment/climate and the resultant negative implications on nature and livelihoods could undermine its economic growth effectiveness.

From the foregoing, it is evidenced that attention has shifted from mainly examining the foreign finance and economic growth nexus which puts aside certain potential factors that limit efficient growth enhancement potentials of foreign capital. Recent studies examine issues around conditionality, the policy environment of the recipient country, human capital, macroeconomic and political stability, governance and institutions, and exogenous economic shocks and structural economic vulnerability as well as external influence (Terefe, 2018; Mercieca, 2010; Guillaumont, 2008; Zuniga, 2011; Agbloyor et al., 2016; Adedokun, 2017; Wako, 2017; Su and Nguyen, 2020; and Mohd and Muse, 2021).

Apart from the aforementioned factors, this study shifts attention to the environment. The key question therefore, is whether foreign finance has resulted in economic prosperity in Ethiopia measured by her per capita GDP growth rate; and what has happened to the environment in Ethiopia given the influx of foreign capital (FDI); and thus, could it be concluded that the interaction of foreign capital with the environment has negative implications on its economic development enhancing potentials? This is because the effectiveness and efficiency of foreign finance on growth and development outcome is conditional particularly in the sense of whether it produces sustainable environmental outcome. Thus, according to Terefe (2018), the interpretations of foreign finance-growth nexus basically fall into two different classifications namely; unconditional and conditional effects of foreign capital. The focus of this study is that the optimality in foreign finance-development relationship in Ethiopia is conditional upon the implications of external finance on the environment or its interactions with the environment through its carbon emissions in the country. In addition, the study also puts forward an empirical assessment of the post-cold war development impact on Ethiopia, the adoption of neoliberal policies in order to attract foreign finance into the economy.

2.0 LITERATURE REVIEW

2.1 Conceptual Review

In view of the nature of the topic, three key concepts have been reviewed. These are foreign finance, climate change and FDI-climate interaction, and the concept of development.

Foreign Finance, FDI-Climate Interaction and Economic Development in Ethiopia: A Time Series Analysis

2.1.1 Foreign Finance

Foreign finance is the inflow of public and private resources or capital from outside an economy in order to close the gaps in domestic savings, foreign exchange earnings or current account imbalance and fiscal deficit. Foreign capital is necessitated by the need for investment in targeted sectors to improve wellbeing of the people in developing countries. The inflow of international resources could be in the form of (a) foreign direct investment by multinational corporations (MNCs) that set up businesses in foreign lands with headquarters in a given country particularly a developed or high-income and upper-middle income countries in America, Europe or Asia; (b) private portfolio investment which takes place through having stake in stocks, bonds, etc. in developing countries' financial markets; (c) remittances of earnings by citizens abroad; and (d) foreign aid/development assistance from private or public sources which could be in the form of loans, grants or donations from foreign governments, multinational institutions/donors, and international nongovernmental organizations (INGOs) (Todaro and Smith, 2014). The study focusses on foreign direct investment and foreign aid in the form of foreign debt to measure foreign finance as these two constitute the highest components of foreign capital.

2.1.2 Climate Change and FDI-Climate Interaction

Climate change means persistent variation in the weather pattern caused by anthropogenic activities mostly connected to industrialization. It manifests itself as a long-term alteration in the average statistics of the weather over time and this could be in the form of variations in expected average values for temperature and precipitation for a given place and time of year, from one decade to the next (Chigbo, Chidozie & Chekwubechukwu, 2016). Climate change has been driven mainly by man's interaction with nature through socioeconomic activities. The interaction with the natural environment by human activities result in the emission of greenhouse gasses (GHGs) especially carbon (CO₂). According to Kempe (2009), climate change is attributed to greenhouse gases (GHGs) like carbon, methane, nitrous oxide and others, produced by human activities - burning of fossil fuels (coal, oil and natural gas) for industrial production, cutting down rainforests etc.- which change the atmosphere's composition by increasing the amount of greenhouse gases, which, in turn, traps more heat in the atmosphere and thereby facilitating climatic change. Carbon (CO₂) accounts for the overwhelming majority of the greenhouse effect that leads to climatic change. Anthropogenic emissions of carbon dioxide accounts for about 63% of the greenhouse gas warming effects in the long term and for 91% in the short term (May and Caron 2009). The advanced countries are quicker enough to realize the adverse environmental consequences of climate change and its resulting negative implications on wellbeing. This prompted strict environmental guidelines in those countries. Hence, with the strict environmental regulations in advanced countries and weak environmental guidelines at home in particularly developing countries, developed countries multinational corporations (MNCs) and other firms relocate their environmentally unsafe industrial activities to less developed countries (LDCs) making the developing countries to become pollution haven. In effect, FDI has brought environmental degradation in LDCs through its interaction with the environment thereby posing threat to sustainable development (Ahmed, et al., 2022; Neequaye & Oladi, 2015; Tang & Tan, 2015; and Al-mulali & Tang, 2013).

2.1.3 Economic Development

Economic growth and economic development have been used interchangeably but they do not necessarily refer to the same thing. Growth refers to the increase, overtime, of an economy's output of goods and services. It does not include the desirable structural changes in the society's socioeconomic arrangement. It only compares output in the current year with that of a previous and overlooks the nature of distribution and wellbeing of the citizens in the economy. The concept of development is more embracing as it is not only concerned with issues of growth but also focuses on the distribution of proceeds from growth. Thus, economic development is generally defined to include improvements in material welfare of people with lowest income, the eradication of mass poverty and illiteracy, reduction in unemployment and inequality, disease and early death, changes in the composition of inputs and outputs that generally include shift in the underlying structure of production away from agricultural towards industrial activities, and environmental sustainability. Therefore, the concept of economic development connotes entire transformation of an economy from a less desirable to a more desirable one, bringing overall improvement in the wellbeing of the entire citizenry or the human conditions (Jhingan, 2007; Todaro and Smith, 2014). In view of this conceptual clarification of development, one is confronted with complexity of indices that could be used in to measure development, hence difficulty in its measurement. The study adopts one of the traditional measurements of the concept in terms of growth in real per capita income which implies expansion in income per head and the output of an economy at a rate faster than the growth rate of its population and improvement in the capacity of the people to acquire more goods and services (Todaro and Smith, 2014).

2.2 Theoretical Framework

The study rests on a tripod of theories namely: The Harrod-Domar growth theory, the exogeneous growth model, and the pollution haven hypothesis (PHH). According to Harrods - Domar growth model, the main objective of foreign capital is filling the saving gap

Foreign Finance, FDI-Climate Interaction and Economic Development in Ethiopia: A Time Series Analysis

in order to enhance the level of investment then improve productivity and economic growth. Hence, it implies that the main purpose of aid is to enhance investment. Generally, the Harrod-Domar growth model also known as the AK model explains that an economy's growth depends directly on the national net savings rate(s) and inversely on the national capital-output ratio. It means that for every economy to grow, it must save a certain proportion of its national income, and must ensure that there is new investment representing net addition to capital stock with lower capital-output ratio. The capital-output ratio means how much and quality of resources needed to produce a certain output or that output growth depends on the efficiency of investment (Todaro and Smith, 2014; Ali, 2020). The conclusion of the H-D model is expressed in the following equation:

$$\frac{\Delta Y}{Y} = \frac{s}{c}$$

The left-hand side of the equation above represents the rate of growth of GDP. On the right-hand side, s is the net national savings ratio and c is the capital-output ratio. The policy implication of the H-D model is that the growth rate of the economy can be influenced by policy makers by designing policies to reduce the capital-output ratio such as investment in human capital and ensuring application of better technology, while influencing increase in the rates of savings and investment. The Harrod –Domar model conclude that the constraints of saving poses limitation to economic growth. Hence, given the realities of developing economies such as Ethiopia, domestic saving alone is not enough for the needed investment level that can attain the necessary growth level, implying that growth is limited by saving gap. Hence, the need for foreign capital to fill this gap and boost domestic saving to achieve the desired rate of growth becomes necessary (Duresa, 2022). However, the major shortcomings of the H-D model are its assumption of fixed capital-labour proportion and the fact that it does not provide for flexibility in factor substitution. The exogenous or traditional neoclassical growth theory developed by Solow and Swan (1956) is also used to investigate the nexus between foreign capital and economic growth. The Solow growth model was originally developed to explain how growths in the capital stock, labor force, and technological advancement interact in an economy to improve a nation's total output of goods and services (Todaro and Smith, 2014; Anyanwu and Oaikhenan, 1995; Mankiw, 1992). Jhingan (1997) asserts that the neoclassical assumption of substitution of labour and capital makes the growth process adjustable and more realistic. In other words, the traditional neoclassical growth model explains that growth comes from one or more of three factors; increase in labour quantity and quality (through population growth and education), increases in capital (through saving and investment), and improvement in technology (Ali, 2020). The growth function takes the following form:

$$Y = f(K, L, T)$$

Where Y = output; K = stock of physical capital; L = Labor force, and T = technological change. The Solow growth model assumes physical capital stock as the main determinant of economy's output, changes in it influences changes in economic growth. Among the different factors that influence capital stock in an economy are both private and public investment (Girma and Tilahun, 2022). They increase the physical capital stock of an economy which in turn result in positive contribution to gross national output. But public investment could be financed from different sources such as tax and foreign capital (Girma and Tilahun, 2022). However, the criticism of the theory is hinged on its assumption that technology and human capital are exogenously determined outside the model, and the theory seems to make developing economies to be dependent on the outside for the attainment of their development aspirations.

With respect to the PHH hypothesis, it is posited that opening up of the economies of developing countries for the inflow of international trade and FDI is likely to result to the degradation of the environment as the activities of the foreign firms is likely to constitute negative externalities such as pollution or emissions of GHGs in the host economy. The PHH in this regard rests on the assertion that the openness of the developing economies will attracts the influx of international trade and FDI of multinational corporations from developed countries with stringent environmental control policies. These multinational corporations by implication will move the production of their pollution intensive products to developing economies where there are poor environmental control policies (Eskeland & Harrison, 2003; Copeland, 2005).

2.3 Empirical Review

2.3.1 Review of Empirical Studies on Foreign Finance and Economic Development Nexus

A number of studies have examined the nexus between foreign finance and some measures of development. Girma and Tilahun (2022) examined the nature and extent of foreign aid and the macroeconomic policy environment contribution to economic growth in Ethiopia over the period 1985 to 2019 employing an autoregressive distributed lag (ARDL) approach. The empirical finding showed that foreign aid has a positive role in economic growth in the long run but its short run effect is found to be insignificant. On the whole, it revealed that both in the short run and long run the predictability of foreign aid has a positive effect both on economic growth. Also, macroeconomic policy index was found to have positive effect in the long run, but its short run effect was shown to be negative.

Foreign Finance, FDI-Climate Interaction and Economic Development in Ethiopia: A Time Series Analysis

Tadesse (2011) investigated the unresolved question of aid effectiveness (measured usually in terms of its impact on economic growth) in Ethiopia with data from 1970 to 2009. The study employed a multivariate cointegration technique. Foreign aid as entered alone revealed positive effect on growth. However, the aid-policy interaction term showed significant negative effect on growth which implies that bad policies have constrained aid effectiveness. Bad policies make aid not to be effective.

Mohd and Muse (2021) analysed the effect of foreign direct investment (FDI) on Ethiopia's economic growth in the years 1981 to 2017. The study used Vector Autoregressions (VARs) model. The empirical finding showed that FDI had positive and significant impact on Ethiopia's economic growth in both the long run and short run. Also, FDI impact on growth was found to be enhanced by human capital and stable macroeconomic environment. Gross fixed capital formation and government consumption had significantly negative impact on economic growth. Furthermore, the study showed that there is no causal relationship between FDI and economic growth.

Duresa (2022) investigated how foreign aid has influenced economic growth and investment in Ethiopia from time 1974 to 2014. The study employed both vector autoregressive model (VAR) and (Vector error Correction model (VECM) to capture short run dynamics. The study found that foreign aid has a significant positive effect on economic progress in both lengthy run and squat run. On other hands, aid has irrelevant and positive effect on gross domestic investment in both extensive time and short run. Foreign direct investment was revealed to be negatively but not significantly related to economic growth. Furthermore, unidirectional causality among foreign aid to economic growth and foreign aid to gross domestic investment was found.

Terefe (2018) examined the drivers of economic growth with focus on interaction between aid and policy and the resulting effect on economic growth of Ethiopia using time series data spanning from 1970 to 2016. It was revealed that foreign aid inflow entered alone is positively and significantly related to economic growth. Also, aid when complemented with policy have a positive contribution to economic growth of the economy.

Agbloyor et al. (2016) investigated the relationship among foreign direct investment (FDI), institutions and economic growth in sub-Saharan Africa. The study used a two-step generalized methods of moments technique. From the whole sample of countries examined, FDI was found not to promote growth; institutions and economic growth had no significant relationship; and institutions do not favourably modify the effect of FDI on economic growth. Excluding countries with developed financial market in the subsample, the study does not find a significant relation between FDI and economic growth. However, it was found that institutions play a direct role in spurring economic growth. Further, the quality of institutions seems to favourably modify the relationship between FDI and economic growth. Also, excluding countries with abundant natural resources in another subsample, evidence of a direct and positive relationship between FDI and economic growth was revealed. In addition, it was found that there exists a direct relationship between institutions and economic growth. However, the growth-enhancing effects of FDI reduced as the quality of institutions improves.

Zuniga (2011) examined the effect of remittances on macroeconomic growth of developing countries employing panel vector autoregression (panel VAR). It was found that remittances have a positive, although small, impact on economic growth with and without considering the role of institutions. However, a distinction by geographical region showed that Eastern European economies obtain more benefit from the flow, followed by the Americas and Asia. African economies do not appear to be significantly affected by remittances.

Adedokun (2017) investigated the differential relationship among foreign aid, governance and economic growth in sub-Saharan Africa (SSA) with data from 1996 to 2012 thus, examining heterogeneity issues in aid recipient countries with further focus on whether governance and size of aid matter, employing the system generalized methods of moments (system GMM) technique. Thus, differences in geographical location, economic status, level of governance, resource endowments and aid size/intensity (the percentage of foreign aid in gross national income, GNI) was considered. Hence, SSA were classified into ten groups to take care of heterogeneity in aid-growth investigation. The findings revealed that foreign aid is negatively and insignificant related to economic growth in aggregate SSA. However, heterogeneity existence across aid recipient economies has implications for aid effectiveness. Moreover, there is complementarity of governance and size of aid in improvement of growth in SSA.

Su and Nguyen (2020) assessed the relationship between the flow of foreign finance (i.e., FDI inflows, ODA, and remittances), human capital, and economic growth in Africa with data from 2002 to 2017, and employing two-step system GMM estimator and fixed effect panel quantile regression techniques. Foreign direct investment (FDI) inflows revealed different effects on economic growth, with negative and positive impacts at low and high levels, respectively. The effects are moderated by the human capital of hosting countries. In addition, ODA and remittances were found to have negative effects on economic growth but human capital of recipient countries reduces these negative impacts. On the whole, the results implications point to the conclusion that foreign financial flows have varying relationship with human capital in their influence on economic growth of recipient countries in Africa, hence pointing to the need for more attention on human capital in these countries, along with other measures to improve absorption of foreign finance.

Foreign Finance, FDI-Climate Interaction and Economic Development in Ethiopia: A Time Series Analysis

Wako (2017) used panel data from 43 sub-Saharan African countries spanning 1980 to 2013 to make contribution to aid-effectiveness debate. The study employed autoregressive distributed lag (ARDL) approach, and also examined roles of institutions, and recipient and donor heterogeneity. The results revealed that aid from traditional donors is negatively related to economic growth. It also revealed donor heterogeneity after disaggregation. Aid from China was found to perform better on economic growth than aid from traditional donors. However, it has a negative institutional effect. Aid effectiveness on growth based on heterogeneity of recipient is also established in the both the short run and long run.

2.3.2 Review of Empirical Studies on Foreign Direct Investment and Climate Change Nexus

Similarly, studies have specifically examined foreign capital (FDI) and climate change nexus. Among these studies is the one conducted by Ahmed et al. (2022) in a panel study of 55 Asian countries. It found that FDI has a negative impact on the environment. The study's finding aligns with the pollution haven hypothesis (PHH), which predicts that FDI inflow increases environmental degradation in developing countries (including Africa) that mostly do not strict regulation against carbon emission. In another study, Huang et al. (2021) examined the impact of FDI inflows on carbon emission in G20 economies using data from 1996 to 2018. It found that FDI inflows increase the emission of carbon. Though, they argued that while emission increases, mitigation of carbon emissions in developed economies increases.

Other empirical studies which results are in line with the PHH are Al-mulali & Tang (2013), Neequaye & Oladi (2015), Tang & Tan (2015). On the other hand, studies like Ren et al., (2014), Seker et al. (2015), Sapkota and Bastola (2017), and Vitenu-Sackey, 2020) produced results that are in contrast with the propositions of the PHH.

From the foregoing, it is obvious that there is inconclusive finding regarding studies that have been conducted on the impact of foreign finance on economic growth in developing countries. Studies have examined the conditions militating against the realization of efficiency in the impact of foreign capital on growth. They hinged the failure of external capital on among others, factors such as weak institutions, policy weakness, poor human capital, and macroeconomic instability. The argument here is that apart from the identified factors in previous empirical findings, the interaction of external capital with the environment in the form of greenhouse gas (GHGs) emissions have negative implications on economic growth influence of foreign capital. The findings from this study could point to the necessity of the need for careful designing of policies to reexamine foreign capital inflow implications on the environment and rethink its acceptability depending on its level of GHGs emissions, environmental compliance and indeed implications on climate change.

3.0 METHODOLOGY

3.1. Data and variables

In order to conduct a time series econometric analysis, the study used annual secondary data over the period 1981 to 2020. The data were sourced from the World Bank online database known as World Development Indicators (WDI), and the Food and Agricultural Organization (FAO) online data base. The 40-year period is selected to meet the requirement of the Central Limit Theorem that a sample size must not be less than thirty years for normality purpose, and that the larger the sample, the greater the reliability or validity of time series research findings (Gujarati, 2005).

3.2 Variables

GDP per capita is used as the dependent variable as it best reveals the extent of development in terms of income per head and it is one of the major indices used in classifying whether a country is developed or not. The independent variables used to capture foreign capital are those considered to be the major sources of foreign finance, and they are foreign direct investment (FDI), and the value of foreign debt. The variables used to measure climate change is carbon emission as a ratio of GDP. This was multiplied by the growth of FDI to derive the variable that measures FDI-climate interaction (FDICO). Thus, climate change (carbon emission) is used as a moderating variable that restrains the potential impact of FDI on economic development in Ethiopia. This measurement of the FDI-climate interaction variable follows from Agbloyor et al. (2016) whose study, in a bid to capture FDI-institutional quality interaction and the resultant impact on per capita GDP in sub-Saharan Africa, derived and included the product of FDI and the institutional indicators to capture the interactive effect between FDI and institutions. The control variables captured are gross fixed capital formation, human development, and openness. The variables selected were from adaptation of the studies of Duresa (2022), Girma and Tilahun (2022), Huang et al. (2021), Mohd and Muse (2021), Su and Nguyen (2020), and Agbloyor et al. (2016).

3.3 Model Specification

The econometric model used for the study is adapted from Agbloyor et al. (2016) and is specified as follows:

$$PCI_t = \beta_0 + \beta_1 FDI_t + \beta_2 FD_t + \beta_3 FDICO_t + \beta_4 GFCF_t + \beta_5 HD_t + \beta_6 OP_t + \beta_7 DUM_t + U_t \dots \dots \dots (1)$$

Where, PCI_t = Growth of GDP per capita

Foreign Finance, FDI-Climate Interaction and Economic Development in Ethiopia: A Time Series Analysis

β_0	=	Constant parameter
β_i	=	Coefficients of the explanatory variables
FDI_t	=	Foreign direct investment
FD_t	=	Foreign debt
$FDICO_t$	=	FDI-climate interaction i.e. FDI growth multiplied by carbon emission (CO ₂) with CO ₂ emission measured as CO ₂ emissions (kg per 2015 US\$ of GDP)
$GFCF_t$	=	Gross fixed capital formation
HD_t	=	Human development
OP_t	=	Openness
DUM_t	=	A dummy variable, with zero (0) representing period of socialist leaning of the country, (i.e period before 1991), and one (1) representing period of adoption of neoliberal policies (1991 and beyond).
U_t	=	Stochastic disturbance term
t	=	Time subscript

Equations 1 is employed as models for this research.

3.4 Technique of Analysis

The model for this research was estimated using Autoregressive Distributed Lag (ARDL) model along with error correction model. The ARDL model is used in the estimation of time series econometrics and it was developed by Pesaran and Shin (1996); Pesaran and Pesaran (2001); for testing the existence of co-integration among variables. The ARDL approach as a cointegration technique has the advantage of allowing for inclusion of variables irrespective of whether they are purely I(0) or I(1), or a mixture of both (Khosravi and Karimi, 2010). However, it cannot accommodate I(2) variables as the computed F-statistics provided by Pesaran, Shin and Smith (2001) will become invalid. This necessitates testing for unit root in the variables of model to be subjected to the ARDL approach to ensure that none of the variables is integrated of order I(2) or beyond. The unit root test was conducted using the Augmented Dickey-Fuller (ADF) technique based on the model expressed below:

$$\Delta Y_t = \beta_0 + \beta_1 Y_{t-1} + \alpha_i \sum Y_{t-i} + \Delta_t \dots \dots \dots (2)$$

- Where:
- Δ = Differenced value of a given time series variable
 - β_0 = Constant Parameter
 - β_1 = Coefficient of the first lag value of the series variable
 - Y_{t-1} = First lag value of a series variable
 - α_i = Coefficient of the lag values of the differenced time series variable
 - ΔY_{t-i} = Lag values of the differenced series variable
 - u_t = Error term.

The Autoregressive Distributed Lag (ARDL) model used in this study is expressed as follows:

$$\Delta PCI_t = \delta_0 + \delta_1 PCI_{t-1} + \delta_2 FDI_{t-1} + \delta_3 FD_{t-1} + \delta_4 FDICO_{t-1} + \delta_5 GFCF_{t-1} + \delta_6 HD_{t-1} + \delta_7 OP_{t-1} + \delta_8 DUM_{t-1} + \sum \lambda_1 \Delta PCI_{t-i} + \sum \lambda_2 \Delta FDI_{t-i} + \sum \lambda_3 \Delta FD_{t-i} + \sum \lambda_4 \Delta FDICO_{t-i} + \sum \lambda_5 \Delta GFCF_{t-i} + \sum \lambda_6 \Delta HD_{t-i} + \sum \lambda_7 \Delta OP_{t-i} + \sum \lambda_8 \Delta DUM_{t-i} + \lambda_8 ECM_{t-1} + u_t \dots \dots \dots (3)$$

- Where δ_0 = Constant Parameter
- Δ = First difference operator
 - δ_i, λ_i = Vector of the parameter of the lagged values of the explanatory variables.
 - ECM_{t-1} = Error correction term
 - u_t = Error term

The error correction dynamics of the model is represented by the parts with terms that have the summation signs (\sum) in the above equation while the second part of the equation with δ_i correspond to the long-run relationship. The null hypothesis in the ARDL equations is $H_0 = a_1 = a_2 = a_3 = 0$. This denotes the absence of long-run relationship while the alternative hypothesis is $H_1: a_1 \neq a_2 \neq a_3 = 0$. The calculated F-statistic is compared with two sets of critical values. One set assumes that all the variables are I(0) and the other assumes they are I(1). If the calculated F – statistic exceed the lower and upper critical value, the null hypothesis of no co-integration will be rejected irrespective of whether the variables are I(0) or I(1). If it is below the upper value bound, there is no cointegration. Once a co-integration relationship has been ascertained the long-run and short run parameters of the relationship are then estimated.

4.0 PRESENTATION AND ANALYSIS OF RESULTS

The findings of the study are presented as follows.

4.1 Trend of FDI and Carbon Emission in Ethiopia

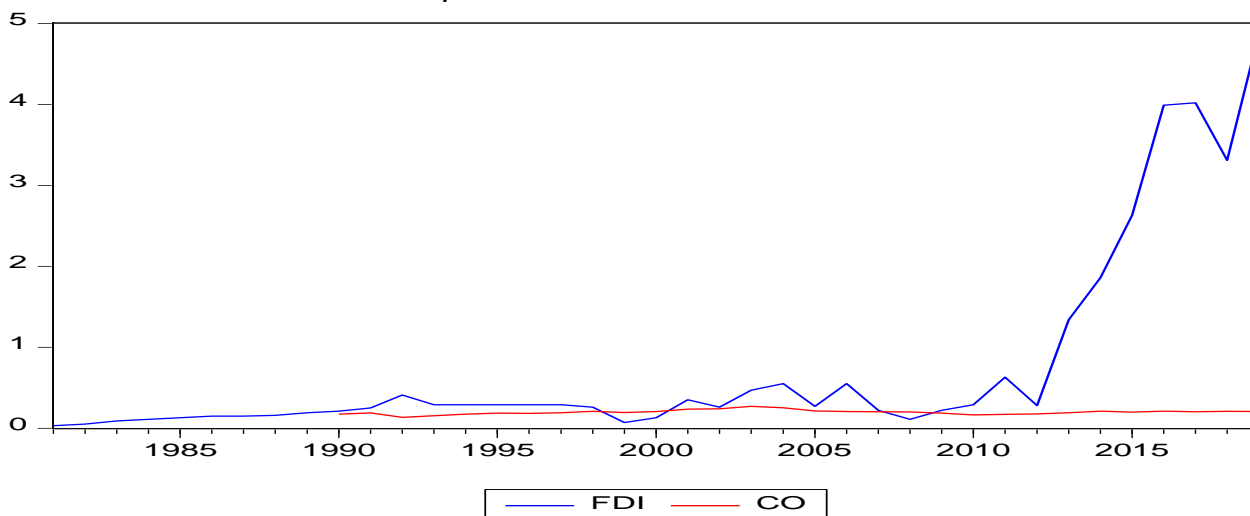

Fig 1: Trend of FDI and Carbon Emission in Ethiopia

Fig 1 presents the trend of FDI and carbon emission in Ethiopia. It could be observed that starting from 1990, CO2 emission as percentage of GDP has remained relatively stable and did not reduce even in the years of reduction in FDI inflow. Also, increase in FDI inflow into the country is not matched with reduction in carbon (CO2) emissions in Ethiopia. Thus, the country could have been a pollution haven for foreign companies that bring in FDI.

4.2 Unit Root Test Results

Table 4.1: Unit Root Tests Results

Variables	Critical Values	ADF Unit Root Test		
		At level I(0)	Critical Values	At First Difference I(1)
PCI	-2.941145	-3.517244**		
FDI			-4.226815	-5.954990***
FD			-4.226815	-5.047204***
FDICO			-3.626784	-9.677495***
CO			-3.689194	5.293716***
GFCF			-3.202445	-3.364282***
HD			-4.226815	-10.94836***
OP			-4.226815	-7.338187***

Source: Authors' estimation using E-views 10

Note: *** Denotes statistical significance at 1% level;

** statistical significance at 5%; and

* Statistical significance at 10%

The outcome of the unit root tests using the Augmented Dickey Fuller (ADF) test presented in Table 4.1 reveals that all the variables satisfy the condition for inclusion in the ARDL model. Table 4.1 shows that per capita income growth (PCI) was found to be stationary at level I(0), while FDI, foreign debt (FD), carbon emission (CO), FDI-climate interaction (FDIGCO), gross fixed capital formation (GFCF), human development (HD) and openness (OP) were all stationary at first difference i.e. I(1). This is because in absolute term, the t-test statistic values of the variables examined were found to be significantly greater than their critical values. Thus, the test statistic values of the variables were either significant at 1% or 5% as the case may be. This implies that none of the series is I(2). Therefore, all the variables were included in the ARDL estimation.

4.3 ARDL Bound Test for Cointegration

Table 4.2: ARDL Bounds Test for Cointegration (ARDL 2,1,2,1,0,1,1,2 Model)

Dependent Variable: ΔPCI	
F-Statistics	8.989313***

Foreign Finance, FDI-Climate Interaction and Economic Development in Ethiopia: A Time Series Analysis

Critical Value	Lower Bound	Upper Bound
10%	1.92	2.89
5%	2.17	3.21
1%	2.73	3.90

Note: *** Statistical significance at 1% level; ** statistical significance at 5%;

* Statistical significance at 10%.

Critical values could also be obtained from Pesaran, shin and Smith (2001).

Source: Authors' computation using E-views 10

The empirical findings of the ARDL bound test results as reported in Table 4.2 implies the existence of cointegration and thus, a long-run relationship between foreign finance, its climate change interaction and economic development in Ethiopia. The F-statistic, 8.989313 is greater than the critical value, 3.90, at the upper bound at 1% level. In view of this, the estimated long-run coefficients are as follows.

4.4 Results of Estimated Long Run Impact of Foreign Finance and FDI-Climate Interaction on Economic Development in Ethiopia

Table 4.3: Estimated Long run and Short Run Coefficients of the Selected ARDL (2, 1, 2, 1, 0, 1, 1, 2) Model

Dependent Variable: D(PCI)		
Independent Variables	Coefficients	P-values
C	163.8132**	0.0123
PCI(-1)	-0.468731****	0.0020
FDI(-1)	385.1698***	0.0059
FD(-1)	-0.282485*	0.0775
FDICO(-1)	-1659.633***	0.0065
GFCF(-1)	10.09293***	0.0002
HD(-1)	-10.58296**	0.0298
OP(-1)	8.650002***	0.0027
DUM(-1)	-65.08281**	0.0312
D(PCI(-1))	0.408973 **	0.0108
D(FDI)	40.05337	0.2751
D(FD)	0.171503	0.5269
D(FD(-1))	0.326634*	0.0618
D(FDICO)	-206.7309	0.2413
D(HD)	1.295582	0.6123
D(OP)	2.375932**	0.0217
D(DUM)	62.04199***	0.0008
D(DUM(-1))	34.29730*	0.0574
ECM(-1)	-0.468731***	0.0000

R² = 0.854499; Adjusted R² = 0.805998

F-Statistic = 296.2038 (0.000000)

Durbin-Watson Statistic = 2.517607

Note: *** Denotes statistical significance at 1% level; ** statistical significance at 5%; and,

* Statistical significance at 10%.

Source: Authors' computation using E-views 10.

Table 4.3 reports the findings on the long run and short run impact of foreign capital, FDI-climate interaction on economic development in Ethiopia. Starting with the lag value of per capita income, the findings reveal that it has negative and significant impact on economic development in Ethiopia. This could be because Ethiopia is a developing economy with low per capita income hence its negative and significant impact on economic development in the country. The general low per capita income is not enough to result in more savings and investment that could bring about the needed development in the long term. However, in the short run, the lag value of per capita income results in positive and significant impact on development in Ethiopia. This could be because the variable could serve as funds needed to take care of current consumption needs thereby boosting aggregate demand which could spur investment in the short run.

Foreign Finance, FDI-Climate Interaction and Economic Development in Ethiopia: A Time Series Analysis

Foreign direct investment (FDI), which is a component of foreign capital in the model is found to have positive and significant impact on economic development in Ethiopia in the long run. This aligns with the argument by Adedokun (2017), Duresa (2022), and Terefe (2018), that external finance in view of the resource gap in developing economies like Ethiopia which impedes the realization of desired investment and prosperity, is needed to fill the savings gap, foreign exchange gap and fiscal gap which then results in positive contribution to economic development. It also conforms with the propositions of the Harrod-Domar growth and neoclassical growth theories that explain the need for saving and growth of capital to enhance economic growth. Therefore, FDI closes the savings gap and serve as capital to boost economic development. The long run empirical finding on FDI is in agreement with the work of Mohd and Muse (2021) that found that FDI had positive impact on economic growth in Ethiopia in the years 1981 to 2017. However, the result is not in conformity with the empirical findings of Duresa (2022) and Agbloyor et al. (2016) that revealed FDI to have negative impact on economic growth in Ethiopia and sub-Saharan Africa respectively. Conversely, the short run impact of FDI on development was found to be though positive but it is not significant. The non-significant positive short run impact could have emanated from challenges of absorptive capacity which could be very worse in the short term before some long run adjustment.

On the other hand, foreign debt was revealed to have long run negative and significant impact on economic development in Ethiopia. This could have resulted from the fact that governance and internal policies and other factors that relate to the absorptive capacity of the economy do not provide enabling ground for positive impact of foreign debt on economic development in the long run. Also, the terms or conditionalities of the debt could have hampered its desired impact on the economy. The result is in line with the works of Wako (2017), Adedokun (2017) but negates the findings of Terefe (2018) and Mohd and Muse (2021). However, external debt could have positive and significant contribution to development in the short run. This could be because in the short run, debt could help in boosting aggregate demand which could enhance growth and development. But in the long run, the impact of debt on economic development becomes negative due to the needed resources to be committed to debt servicing considering the possible unfavourable debt to revenue ratio, as the servicing constitute leakage which goes outside the economy and it could have been used to finance other development projects.

FDI-climate interaction term was found to have long run negative and significant effect on economic development in Ethiopia. This implies that though FDI on its own could have positive contribution to development but the moment it tinkers with the climate through carbon emission, it results in negative implication on economic development of Ethiopia. This is because climate change could be exacerbated by FDI inflows as revealed in studies by Ahmed et al. (2022), Huang et al. (2021), Al-mulali & Tang (2013), Neequaye & Oladi (2015), and Tang & Tan (2015). The intensification of environmental problems by FDI brings about loss of livelihoods as it affects agriculture and other climate-sensitive sectors, result in health challenges, and loss of biodiversity due to ecosystem disruption. These erode or constrains the positive impact which FDI could have potentially had on the economic development of recipient countries such as Ethiopia. As could be seen from Table 4.3, the negative coefficient of FDI-climate interaction term is more than the positive coefficient of FDI, implying the complete eroding of FDI's potential impact on development. The non-significant negative short run impact of the variable on economic development could have resulted from the fact that climate change, and indeed the one that could have emanated from FDI inflow and its interaction with the environment manifests its much negative impact on the economy in the long run.

Gross fixed capital formation was revealed to have significant and positive impact on economic development in Ethiopia. In addition, human capital was found to be negatively associated with economic development in Ethiopia the long term, and the short term impact of the variable which was though found to be positive is insignificant. This could be due to low human development or inadequate investment on human capital development in the country which have negative implications on the earnings of the people that could translate in their better living hence entire development of the economy. However, the finding is not in line with the work of Su and Nguyen (2020) that found positive and significant impact of human capital on economic growth in Africa. On the other hand, openness was found to result in positive and significant impact on economic development of the country in both the long run and short run. The positive coefficient of the variable could be because trade liberalization result in better access to commodities which could not be produced locally and also facilitate technological diffusion hence translates in better living/welfare, more investment, and general development in the long run. However, the dummy variable representing years of adoption of neoliberal policies revealed negative impact on economic development in Ethiopia, which implies that neoliberal policies as adopted by the country in order to boost foreign capital inflow has not resulted in economic prosperity of the Ethiopian economy. The error correction term has the expected negative sign and it is significant, implying that the model reverts back to long run equilibrium after disturbance hence it is a stable model.

4.5 Robustness Test

Table 4.4: Robustness Test (Post-Estimation Test)

Diagnostic Test	F-Statistics	DF	Probability
Serial Correlation (B-G)	3.536097	2,8	0.0507
Heteroscedasticity	1.102735	16,20	0.4127
Jaque-Bera Normality Test	1.757143		0.4154
Ramsey RESET Test	0.060332		0.8066

Source: Authors' computation using E-views 10.

From the Linear ARDL model, the post estimation tests of serial correlation, heteroscedasticity and normality are insignificant at 5 percent level of significance which means that their null hypotheses are not rejected. That is, the model is well specified, free from serial correlation, heteroscedasticity and normally distributed respectively. The Rasmsey RESET test also reveals that the model is stable. The value of the normality test is further revealed in the histogram and table below, and they show that the model follows normal distribution assumption.

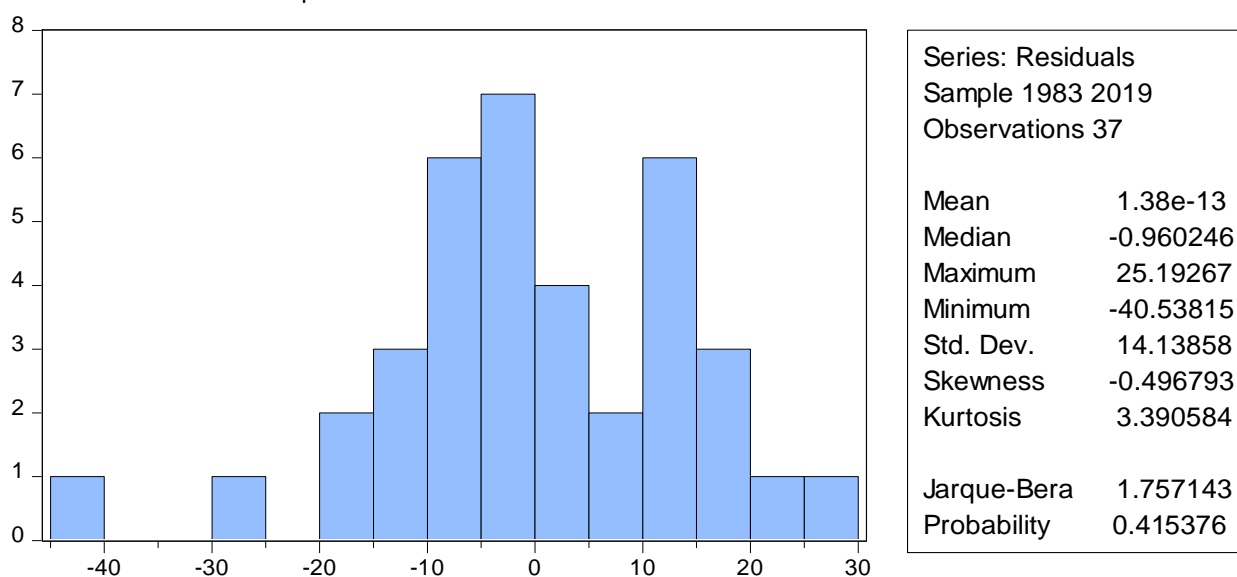

Figure 2: Normality Test for the ARDL Model

5.0 CONCLUSION, POLICY IMPLICATIONS AND RECOMMENDATIONS

The study has revealed the long run and short run impact of foreign finance on economic development in Ethiopia. It has also explained that the economy has tilted its macroeconomic management strategy along the path of neoliberalism and that this had resulted in more inflow of foreign capital. However, it could be concluded from the empirical findings that foreign capital constituents have mix of positive and negative development outcome depending on the component, and whether it is examined from the short-term and long-term impacts. While FDI was found to have long run positive impact, foreign debt revealed long run negative effect on Ethiopia's prosperity measured by per capita income. It could be concluded also that any study on foreign capital and development nexus would be better conducted if certain potential factors which limit its growth and development outcome are incorporated into the research in the area. Therefore, apart from issues around conditionality, the policy environment of the recipient country, human capital, macroeconomic and political stability, governance and institutions, and exogenous economic shocks and structural economic vulnerability as well as external influence examined in existing studies (Terefe, 2018; Mercieca, 2010; Guillaumont, 2008; Zuniga, 2011; Agbloyor et al., 2016; Adedokun, 2017; Wako, 2017; Su and Nguyen, 2020; and Mohd and Muse, 2021), the environmental/climate impact of foreign capital which further limit its impact on development should also be the focus of empirical studies.

The further conclusion here is that foreign finance especially FDI could positively influence development and it is an important component of the economy of Ethiopia but its ensuing interaction with the environment/climate could result in its limited and even negative implication on economic prosperity in the economy. Therefore, the effectiveness and efficiency of foreign finance on growth and development outcome in Ethiopia and the gains from its adoption of neoliberal policies is conditional particularly in the sense of whether it produces long run sustainable environmental outcome, and upon the absorptive capacity of the

Foreign Finance, FDI-Climate Interaction and Economic Development in Ethiopia: A Time Series Analysis

economy particularly in terms of infrastructure and institutional quality. In addition, the study also reveals that the adoption of market-oriented policies starting from 1991 and jettisoning of socialist orientation of the country to attract foreign capital into the economy of Ethiopia has not resulted in its economic development. Based on the empirical findings, the study provides policy implication to the government of Ethiopia as well as development partners in the area of assessment of the long run potential environmental impact of foreign capital before they are deployed on the economy. There is need for adoption of debt-for-climate swap as currently being advocated, where bilateral and multilateral debts of Ethiopia and other developing countries are forgiven in exchange for a commitment by the debtor to use outstanding debt service payments for national climate change mitigation and adaptation programs.

The government of Ethiopia should ensure stable macroeconomic environment, proper negotiation, and optimal allocation of foreign capital to sustainable development projects (or to growth and development enhancing sectors) and reducing wastage rather than spending it on overheads that have no meaningful bearing on long term sustainable economic development. Furthermore, there is need for consideration of, and building the absorptive capacity and ensuring proper mechanism for monitoring and evaluation in order to bring about better effectiveness of foreign capital and reforms. Finally, government should be inward-looking through enhancement of the tax base and tax revenue to reduce dependency on foreign finance.

REFERENCES

- 1) Adebayo, T. S. & Kalmaz, D. B. (2020). Ongoing Debate between Foreign Aid and Economic Growth in Nigeria: A Wavelet Analysis. *Social Science Quarterly*. DOI: 11.111/ssqu.12841.
- 2) Adedokun, A. J. (2017). Foreign aid, governance and economic growth in Sub-Saharan Africa: Does one cap fit all? *African Development Review*, 29(2), 184–196.
- 3) Agbloyor, E. K., Gyeke-Dako, A., Kuipo, R. & Yindenaba Abor, A. Y. (2016). Foreign Direct Investment and Economic Growth in SSA: The Role of Institutions. Accessed from <http://wileyonlinelibrary.com>. DOI: 10.1002/tie.21791.
- 4) Ahmed, F. Ali, I., Kousar, S., & Ahmed, S. (2022). The environmental impact of industrialization and foreign direct investment: Empirical evidence from Asia-Pacific region. *Environmental Science and Pollution Research*, 29, 29778–29792.
- 5) Ali, M. (2020). 'Economic Growth and Development in Nigeria: Theoretical Review'. Chapter 6, pp. 71-80. *Topical Issues in Social Sciences: A Book of Readings*. Faculty of Social Science Book of Readings, Kogi State University, Anyigba, Nigeria.
- 6) Ali, M. (2022). Climate Change and Africa: Rising Population, and Constraints to Socioeconomic Development. Being a Public Lecture Delivered to Participants of Executive Intelligence Management Course Fifteen (EIMC 15), On Thursday 24th March, 2022, at the National Institute for Security Studies, Bwari-Abuja, Nigeria.
- 7) Al-mulali U., & Tang, C. F. (2013). Investigating the validity of pollution haven hypothesis in the gulf cooperation council (GCC) countries. *Energy Policy*, 60, 813–819.
- 8) Anyanwu, J.C & Oaikhenan, H.E. (1995); *Modern Macroeconomics: Theory and Applications in Nigeria*, Joanie Educational Publisher Ltd, Onitsha, Nigeria.
- 9) Asongu, S. A., Nwachukwu, j., & Biekpe, N. (2018). Foreign aid, terrorism and growth: conditional evidence from quantile regression. *Annals of Public and Cooperative Economics*, 90(3), 457–486. doi:10.1111/apce.12235.
- 10) Copeland, B. R. (2005). Policy endogeneity and the effects of trade on the environment. *Agricultural Resource. Economics Review*. 34 (1), 1–15.
- 11) Demissie, F. (2008). Situated neoliberalism and urban crisis in Addis Ababa, Ethiopia. *African Identities*, 6(4), 505-527.
- 12) Domar, E. (1946). Capital expansion, rate of growth and employment. *Econometrica*. 14, 137-147.
- 13) Duresa, M. K. (2022). Effect of Foreign Aid on Economic Growth and Investment in Ethiopia. *International Journal of Economics, Finance and Management Sciences*, 10(1), 12-2. Doi: 10.11648/j.ijefm.20221001.12.
- 14) Eskeland, G. S., & Harrison, A. E. (2003). Moving to greener pastures? Multinationals and the pollution haven hypothesis. *Journal of Development Economics*. 70 (1), 1–23.
- 15) Girma, T. & Tilahun, S. (2022) Predictability of foreign aid and economic growth in Ethiopia, *Cogent Economics & Finance*, 10(1), 1 – 24, 2098606, DOI: 10.1080/23322039.2022.2098606.
- 16) Guillaumont, P. (2008). To move out of the trap-The least developed countries. *Pari: Economica*.
- 17) Gujarati, D. N. 2005. *Basic Econometrics* (Fifth Reprint). New Delhi: Tata MacGraw Hill.
- 18) Harrod, R. F. (1948). *Towards a dynamic economics*, Macmillan.
- 19) Huang, Y., Chen, F., Wei, H., Xiang, J., Xu, Z., & Akram, R. (2022). The Impacts of FDI Inflows on Carbon Emissions: Economic Development and Regulatory Quality as Moderators. *Frontiers in Energy Research*, 9, 1-11.
- 20) Jhingan, M.L. (1997). *Macro-economic Theory*. Vrinda Publications (p) Ltd, Delhi.

Foreign Finance, FDI-Climate Interaction and Economic Development in Ethiopia: A Time Series Analysis

- 21) Mankiw N.G. (1992). *Macroeconomics*, Worth publisher, New York.
- 22) Mekuria, W. (2021). Neo-liberalism and structural adjustment programs: Effects of institutional reforms on agriculture based economy in Ethiopia. *Acta Scientific Agriculture*, 5(5), 75-85.
- 23) Mercieca, P. (2010). Aid and economic growth in developing countries: A literature review. Retrieved from <https://www.bov.com/documents/bov-review-41-paper-1>.
- 24) Mohd, S. & Muse, A. N. (2021). Impact of foreign direct investment on economic growth in Ethiopia: Empirical evidence. *Latin American Journal of Trade Policy* 10, 56 – 77.
- 25) Moyo, D. (2009), 'The world of aid' in dead aid: Why aid is not working and how there is a better way for Africa, pp. 1–70. Farrar, Strauss, and Giroux, New York.
- 26) Neequaye, N. A., & Oladi, R. (2015). Environment, growth, and FDI revisited. *International Review of Economics and Finance journal homepage*, 39, 47–56.
- 27) Opoku, E.E.O., & Boachie, M.K. (2019). The environmental impact of industrialization and foreign direct investment. *Energy Policy*. <https://doi.org/10.1016/j.enpol.2019.111178>.
- 28) Ren, S., Yuan, B., Ma, X., & Chen, X. (2014). International trade, FDI (foreign direct investment) and embodied CO2 emissions: a case study of Chinas industrial sectors. *China Economic Review* 28, 123–134.
- 29) Sapkota, P, & Bastola, U. (2017) Foreign direct investment, income, and environmental pollution in developing countries: Panel data analysis of Latin America. *Energy Economics*, 64, 206–212.
- 30) Seker, F., Ertugrul, H.M., & Cetin, M. (2015). The impact of foreign direct investment on environmental quality: a bounds testing and causality analysis for Turkey. *Renewable and Sustainable Energy Reviews*, 52, 347-356.
- 31) Solow, R. M. (1956). A contribution to the theory of economic growth. *Quarterly Journal of Economics*, 70(1); 65-94.
- 32) Su, T. D. & Nguyen, C. P. (2020). Foreign financial flows, human capital and economic growth in African developing countries. *Int J Fin Econ*, 1–22. DOI: 10.1002/ijfe.2310
- 33) Swan, T. W. (1956). Economic growth and capital accumulation. *Economic Record* 32(2); 334-361.
- 34) Tadesse, T. (2011). Foreign aid and economic growth in Ethiopia: A cointegration analysis. *The Economic Research Journal*, 1(2), 88-108.
- 35) Tang, C. F., & Tan, B. W. (2015). The impact of energy consumption, income and foreign direct investment on carbon dioxide emissions in Vietnam. *Energy*, 79, 447–454.
- 36) Terefe, K. D. (2018). Drivers of economic growth in Ethiopia: Does foreign aid and policy complementarity matter? *Journal of Economics and International Finance*, 10(8), 95 - 110. DOI: 10.5897/JEIF2017.0866.
- 37) Todaro, M. P. & Smith, S. C. (2014). *Economic Development* (12th Edition). Pearson Educational Limited, England.
- 38) Vitenu-Sackey, P. A. (2020). Financial development, foreign direct investment and Carbon emissions: A comparative study of West Africa and Southern Africa Regions. *International Review*, 6 (1), 1550-1569.
- 39) Wako, H. A. (2017). Aid, institutions and economic growth in sub-Saharan Africa: Heterogeneous donors and heterogeneous responses. *Review of Development Economics*, 22(1), 23–44. doi:10.1111/rode.12319
- 40) Zuniga, M. C. (2011). On the path to economic growth, do remittances help? Evidence from panel VARs. *The Developing Economies* 49(2), 171–202.



There is an Open Access article, distributed under the term of the Creative Commons Attribution – Non Commercial 4.0 International (CC BY-NC 4.0) (<https://creativecommons.org/licenses/by-nc/4.0/>), which permits remixing, adapting and building upon the work for non-commercial use, provided the original work is properly cited.

Design and Implementation of Line Follower Robot for Automatic Watering of Orchid Plants



Aep Setiawan¹, Irzaman², Mahfuddin Zuhri³, Muchammad Alifandino Satrio⁴, Herlambang Nurasyid Ramdhani⁵, Muhammad Iqbal⁶, Raihan Abrar Baihaki⁷

^{1,4,5,6,7}Computer Engineering Technology: IPB University Vocational School, Bogor, Indonesia

^{2,3}Department of Physics, Faculty of Mathematics and Natural Sciences, IPB University, Bogor, Indonesia

ABSTRACT: This study studies how the line follower robot is made and used for the automation of watering orchid plants. The purpose of using this robot is to reduce the involvement of human hands in the watering process and improve the efficiency of water use. This robot, which is made with an Arduino microcontroller, has an infrared sensor that can detect paths and has an automatic water pump for water distribution. The tests were carried out in a greenhouse where the orchids were well cared for. The results show that the robot can effectively water plants by saving up to 35% water compared to manual methods and increasing productivity by 20%. This invention can be applied on a larger scale in the horticultural industry.

KEYWORDS: Line Follower Robot, Automatic Watering, Water Efficiency, Orchid Plants, Microcontroller

I. INTRODUCTION

Agriculture continues to develop automation to address issues such as labor limitations and resource efficiency, especially water. Orchids, one of the most valuable ornamental plants, require special care, including regular and regular watering [1]. Manual watering methods often pose problems such as moisture imbalances, which can lead to stress on the plant or death due to rotting roots or lack of water [2]. To address this issue, automatic watering technologies, including robots, have become an increasingly popular option.

The line follower robot is one of the technologies that has been widely used in various industries. These robots perform repetitive tasks automatically by using sensors, usually infrared sensors, to follow a predetermined path [3]. Depending on the specific needs of the plant, the path-following robot can be used in agriculture for a variety of tasks, such as watering, fertilizing, or harvesting [4]. Orchids, which have a specific pattern of water needs, are one type of plant that is perfectly suited to using this technology. The line follower robot equipped with an automatic watering system allows for more accurate watering settings, which results in increased productivity and reduced human error [5].

Previous research has shown that line follower robots are useful in horticulture. For example, research conducted by Hsiao (2011) found that the line-following robot has the ability to reduce water use by up to 30% in the use of automatic watering in greenhouses [6]. Since orchids are very sensitive to unsuitable water conditions, the orchid's watering needs are more important [7]. Instead, the study focused more on vegetable crops. Additional research by Baharuddin (2006) looked at the use of line follower robots for automatic watering in open fields, which showed a 25% increase in water efficiency [8]. However, the study also had problems with the robot's accuracy when moving on uneven surfaces. Unlike previous research, this study concentrates on the use of line follower robots in greenhouse environments.

The purpose of this study is to create and apply a line follower robot intended to water orchid plants on a greenhouse scale. The robot in this study will be equipped with infrared sensors to detect watering paths and automatic water pumps that are controlled at certain points along the path. Tests are conducted to evaluate the robot's performance under various environmental conditions, including path accuracy, water use efficiency, and reliability. The results of this study will be compared with previous research to help understand the advantages and disadvantages of this system and help the advancement of automatic watering technology in the agricultural sector, especially for orchid plants.

Design and Implementation of Line Follower Robot for Automatic Watering of Orchid Plants

Path-following robots were first used in the manufacturing and transportation industries to follow specific paths. However, it is starting to be used more in agriculture due to the need for efficiency, especially in water management [9]. In some studies, path-following robots have been used to water plants in greenhouses; The study found that robotic watering can improve water efficiency by up to 30% compared to manual watering [10].

Unlike other plants, orchids need consistent watering without too much water. Too much watering can lead to root rot, while too little watering can stunt growth [11]. Sensor-based, the automation system can monitor soil moisture in real-time and adjust watering according to the needs of specific plants [12].

II. MATERIALS AND METHODS

A. Robot Design

The ESP32 microcontroller was used as the control center of the robot designed for this study. The system has a mini water pump for automatic watering, a DC motor that functions as a drive, and an infrared sensor that detects the path [13]. The watering path consists of a black line laid between the orchid pots, and the infrared sensor detects this path to determine the route [14].

B. Network Schematics

Figure 1 is a schematic of the circuit for the car and Figure 2 is a schematic of the circuit for the remote.

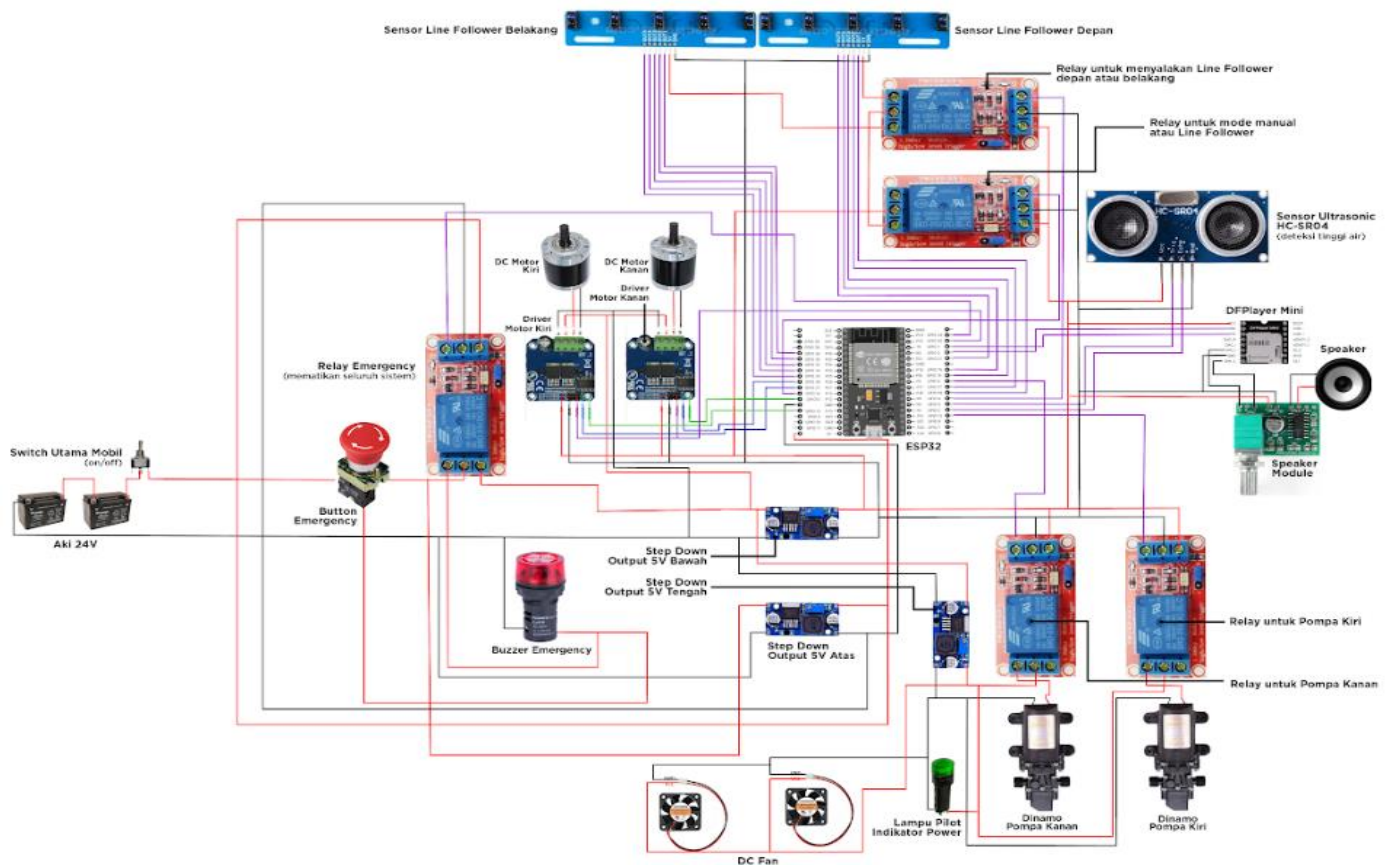

Figure 1. Car Range

Design and Implementation of Line Follower Robot for Automatic Watering of Orchid Plants

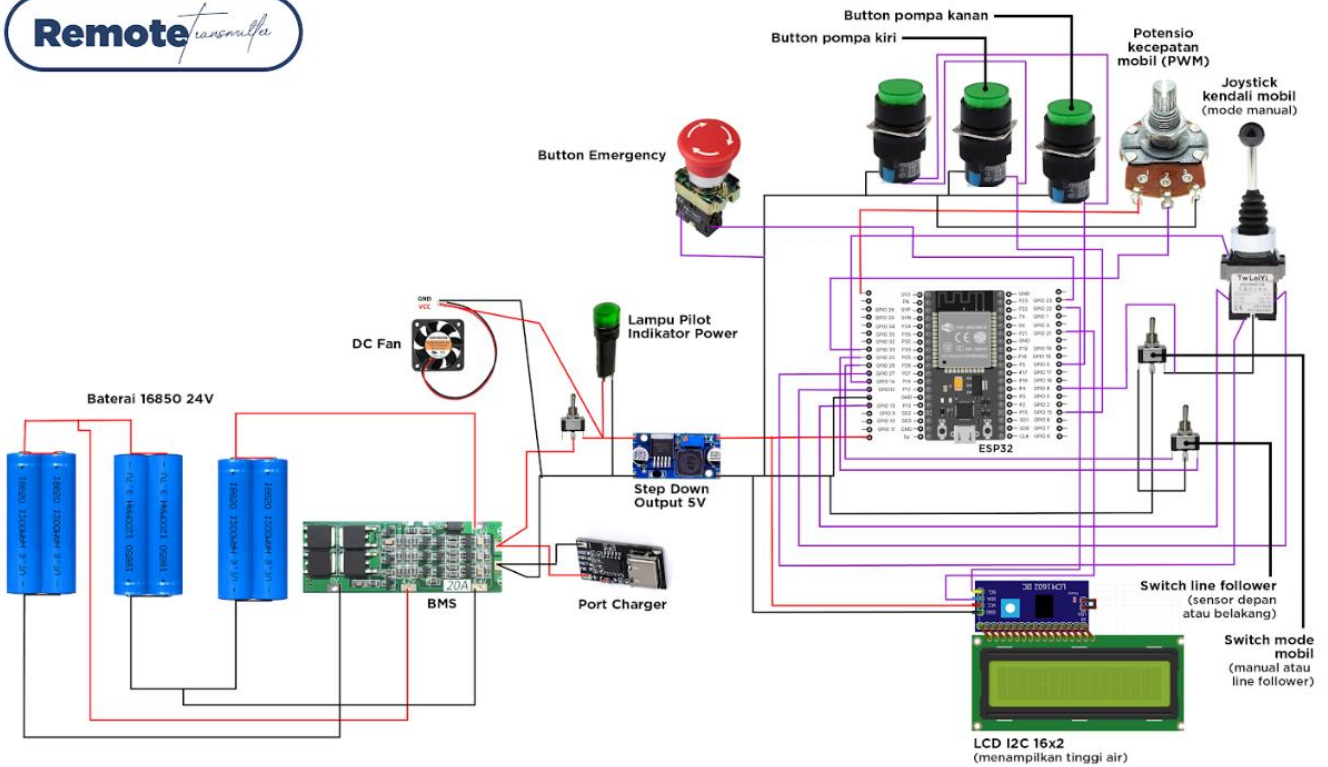

Figure 2. Car Remote Series

C. Robot Structure

Figure 3 is the structure of the robot.

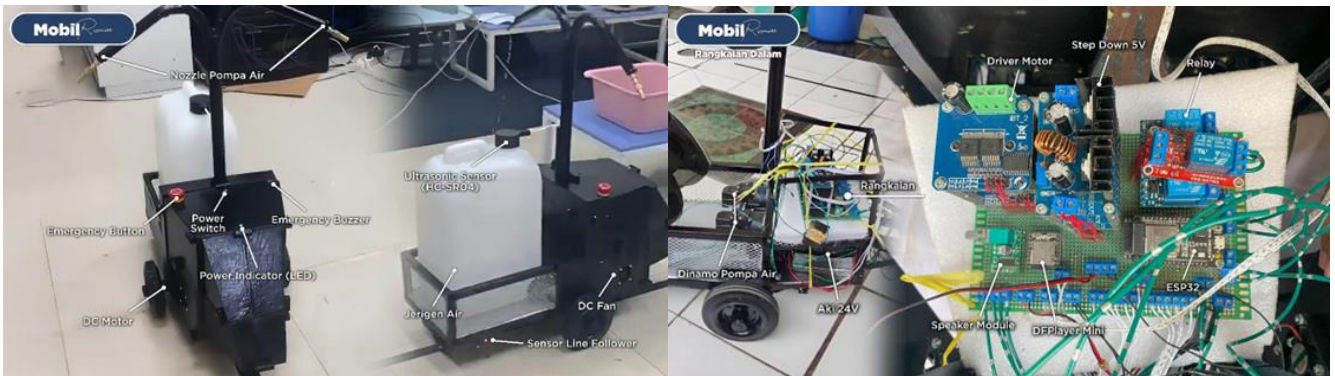

Figure 3. Robot Structure

D. Remote Structure

In Figure 4 is the structure of the remote



Figure 4. Remote Structure

Design and Implementation of Line Follower Robot for Automatic Watering of Orchid Plants

E. Software Implementation

The robot's control algorithm, developed using the C++ programming language and integrated within the Arduino IDE platform, is designed to follow the path very accurately, reducing errors such as out-of-path or watering failures [15]. The sensor identifies the location of the plant, which causes the watering conditions. When the robot reaches a pre-programmed point, the water pump works.

F. Trial and Testing

In a greenhouse, the trial was carried out with 20 pots of orchid plants arranged in a row along a certain path [16]. To ensure consistent performance, the robot is tested under a variety of humidity and temperature conditions. Each testing session involves five watering cycles with time intervals set according to the needs of the orchid plant [17].

III. RESULTS AND DISCUSSION

The Plant Watering Line Follower Robot, as the name implies, is a car that has two modes, namely manual and line follower, which can be used to water plants on the right and left. For the turning system, this car uses the Skid Steering method where the car turns by making one side of the wheel forward, the other side backward. For example, if you want to turn right, then the right wheel will go backwards while the left wheel will go forward, and vice versa.

The Plant Sprinkler Line Follower Robot has a variety of features, including Manual Mode where users can move the car manually using the joystick on the remote. Line Follower mode where users can also change the car mode to line-following mode where the car will follow the path created through the line follower sensor. The Line Follower mode itself has two options on the remote, namely Forward and Backward. When Forward mode is activated, the car will follow the path forward, using the line follower sensor in front of the car. Backward mode is activated, then the car follows the path towards the rear, using the line follower sensor behind the car. The Sound of the Mode Indicator is activated when switching car modes (between manual or line follower), there is an indicator sound that tells what mode is being used. The speed of the car can be adjusted using the potentiometer located at the bottom of the remote, so it can be controlled. The process of watering plants uses buttons on the side and back of the remote, then there are two nozzles on the car located on the right and left to water the plants. The Water Level can be displayed on the LCD so that you can see the water level on the jerry can. The water level in the jerry can is detected using the ultrasonic sensor HC-SR04. The remote used uses a battery that can be cashed, where the port for the charger uses type-C so it is easier to charge the battery. There is an emergency button on the remote and car where its function is to stop the entire car system and turn on the emergency buzzer on the car. The line follower robot has been successfully created and running as expected.

The trail-following robot successfully completes the watering cycle correctly. The robot showed path accuracy of 98% and proper watering in 96% of the 100 watering sessions carried out over 20 days. Water use becomes much more efficient, with a 35% reduction in water consumption when compared to manual watering. The use of infrared sensors has been shown to be successful in detecting paths, but problems arise when paths are obstructed by soil or other materials. The solution to this problem could be an improvement in algorithms to detect obstacles more accurately or the use of more advanced sensor technologies such as LIDAR. The automatic watering system increases the productivity of farmers and allows for more consistent and scalable crop maintenance. In addition, this system reduces the amount of time required for watering.

V. CONCLUSION

There is evidence that the use of line follower robots for watering orchid plants simplifies the process of plant maintenance and improves water use efficiency [18]. The horticulture industry has a lot of room for the application of this technology, especially for plants such as orchids that are in dire need of watering [19]. The development of hardware and controller algorithms is expected to improve the performance of robots, especially in more complex environments [20].

REFERENCES

- 1) P. Nongdam *et al.*, "Orchid Micropropagation Using Conventional Semi-Solid and Temporary Immersion Systems: A Review," *Plants*, vol. 12, no. 5, pp. 1–32, 2023.
- 2) E. Semiarti, A. Purwantoro, A. Indrianto, A. B. Sasongko, O. Herawati, and A. F. Milasari, "Innovation of Natural Orchid Cultivation Technology for Tourism Development in Banyunganti Hamlet, Jatimulyo Village, Girimulyo Sub-District, Kulon Progo District, Yogyakarta," *J. Trop. Biodivers. Biotechnol.*, vol. 5, no. 3, pp. 178–182, 2020.
- 3) F. I. Khawaja, A. Kanazawa, J. Kinugawa, and K. Kosuge, "A human-following motion planning and control scheme for collaborative robots based on human motion prediction," *Sensors*, vol. 21, no. 24, pp. 1–17, 2021.

Design and Implementation of Line Follower Robot for Automatic Watering of Orchid Plants

- 4) M. F. Saleem *et al.*, "Applications of sensors in precision agriculture for a sustainable future," *Agric. Aquac. Appl. Biosens. Bioelectron.*, no. February, pp. 109–137, 2024.
- 5) S. Touil, A. Richa, M. Fizir, J. E. Argente García, and A. F. Skarmeta Gómez, "A review on smart irrigation management strategies and their effect on water savings and crop yield," *Irrig. Drain.*, vol. 71, no. 5, pp. 1396–1416, 2022.
- 6) M. A. Baballe, A. I. Adamu, A. S. Bari, and A. Ibrahim, "Principle Operation of a Line Follower Robot," *Far East J. Electron. Commun.*, vol. 27, no. August, pp. 1–12, 2023.
- 7) Y. Y. Hsiao *et al.*, "Research on orchid biology and biotechnology," *Plant Cell Physiol.*, vol. 52, no. 9, pp. 1467–1486, 2011.
- 8) M. Z. Baharuddin, I. Z. Abidin, and S. S. K. Mohideen, "Analysis of Line Sensor Configuration for the Advanced Line Follower Robot," *Proc. Student Conf. Res. Dev. (SCOReD), Bangi, Selangor, Malaysia.*, no. December, pp. 1–12, 2006.
- 9) R. Ramin Shamshiri *et al.*, "Research and development in agricultural robotics: A perspective of digital farming," *Int. J. Agric. Biol. Eng.*, vol. 11, no. 4, pp. 1–11, 2018.
- 10) A. A. Kulkarni, P. Dhanush, B. S. Chetan, C. S. Thamme Gowda, and P. K. Shrivastava, "Applications of Automation and Robotics in Agriculture Industries; A Review," *IOP Conf. Ser. Mater. Sci. Eng.*, vol. 748, no. 1, 2020.
- 11) K. R. Aravind, P. Raja, and M. Pérez-Ruiz, "Task-based agricultural mobile robots in arable farming: A review," *Spanish J. Agric. Res.*, vol. 15, no. 1, 2017.
- 12) Y. Jin, J. Liu, Z. Xu, S. Yuan, P. Li, and J. Wang, "Development status and trend of agricultural robot technology," *Int. J. Agric. Biol. Eng.*, vol. 14, no. 4, pp. 1–19, 2021.
- 13) W. Budiharto, E. Irwansyah, J. S. Suroso, and A. A. S. Gunawan, "Low-Cost Vision-Based Face Recognition Using Esp32-Cam for Tracked Robot," *ICIC Express Lett. Part B Appl.*, vol. 13, no. 3, pp. 321–327, 2022.
- 14) M. H. Widiyanto and B. Juarto, "Smart Farming Using Robots in IoT to Increase Agriculture Yields: A Systematic Literature Review," *J. Robot. Control*, vol. 4, no. 3, pp. 330–341, 2023.
- 15) A. Latif, H. A. Widodo, R. Rahim, and K. Kunal, "Implementation of line follower robot based microcontroller atmega32a," *J. Robot. Control*, vol. 1, no. 3, pp. 70–74, 2020.
- 16) H. Chowdhury, D. B. P. Argha, and M. A. Ahmed, "Artificial Intelligence in Sustainable Vertical Farming," 2023.
- 17) G. B. Caceres, P. Millan, M. Pereira, and D. Lozano, "Economic Model Predictive Control for Smart and Sustainable Farm Irrigation," *2021 Eur. Control Conf. ECC 2021*, pp. 1255–1260, 2021.
- 18) C. Cheng, J. Fu, H. Su, and L. Ren, "Recent Advancements in Agriculture Robots: Benefits and Challenges," *Machines*, vol. 11, no. 1, pp. 1–24, 2023.
- 19) M. Wakchaure, B. K. Patle, and A. K. Mahindrakar, "Application of AI techniques and robotics in agriculture: A review," *Artif. Intell. Life Sci.*, vol. 3, no. November 2022, p. 100057, 2023.
- 20) A. T. Balafoutis, F. K. van Evert, and S. Fountas, "Smart farming technology trends: Economic and environmental effects, labor impact, and adoption readiness," *Agronomy*, vol. 10, no. 5, pp. 1–26, 2020.

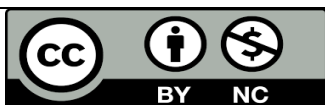

There is an Open Access article, distributed under the term of the Creative Commons Attribution – Non Commercial 4.0 International (CC BY-NC 4.0) (<https://creativecommons.org/licenses/by-nc/4.0/>), which permits remixing, adapting and building upon the work for non-commercial use, provided the original work is properly cited.

Commodity Analysis of Carbohydrate Food Availability in the Banyumas Regency Area



Fitrizka Acha Fimbriata¹, Mukson, Bambang Dwiloka²

Fakultas Peternakan Dan Pertanian, Universitas Diponegoro, Indonesia

ABSTRACT: The study aims to determine the potential of carbohydrate food sources regarding the availability of carbohydrate food sources in Banyumas Regency. The research method is carried out through descriptive research. The data used in this study are primary data sourced from the services or agencies related to the problem being studied, namely the Banyumas Regency BPS, and the Banyumas Regency Agriculture Service. With SPSE analysis. The results of the study concluded that in Banyumas Regency there is availability of carbohydrate food sources, namely rice, corn, and cassava. The suitability of land and climate conditions is the main consideration for farmers to grow rice, corn, and cassava. Dry or marginal land in Banyumas Regency can be planted with one or even all three of these plants. In carbohydrate commodities in the last 5 years, namely in 2019-2023, almost every sub-district has a good food security value. Where these conditions make rice, corn and cassava the main commodities to meet food availability

KEYWORDS: Carbohydrate Commodities, Rice, Corn, Cassava, Food Availability

I. INTRODUCTION

Food is an important and strategic commodity, considering that food is a basic human need (Rozi et al., 2023). At all times in every settlement, food needs to be available, in sufficient quantities, with adequate quality, safe for consumption and at a price that is affordable for the community (Mkhize et al., 2023). Providing food for the entire population is one of the most crucial issues in every country (Odo et al., 2023) states that the most basic need is the need for food. In general, 100% fulfillment, which means that almost all households consume rice. Every era of government in Indonesia has consistently committed to maintaining the availability of domestic rice because of its very important role. In addition to rice, other carbohydrate sources that are commonly consumed are rice, corn, cassava, sweet potatoes, and wheat and its derivatives such as bread and instant noodles (Farida et al., nd). Rice, cassava and sweet potatoes are important commodities in the staple food diversification program (Mulyaningtiyas & Supriyono, 2024a). Meanwhile, according to Law Number 18 of 2012 concerning Food, it is food consumed by the local community in accordance with local wisdom. The policy of food diversification in accordance with local wisdom is based on Presidential Regulation Number 22 of 2009 concerning the Policy for Accelerating the Diversification of Food Consumption Based on Local Resources (Wijayati & Suryana, 2019a).

Each region has different potential resources. Banyumas Regency has a very diverse variety of food (Floresti et al., 2023). Several important raw materials that support the food security system are developed here on a large scale, including plants containing carbohydrates, rice, corn, cassava, and sweet potatoes (Mulyaningtiyas & Supriyono, 2024b). So that in every sub-district of Banyumas Regency must have fulfillment and income for special needs in carbohydrates. Household income will increase the amount demanded at a certain price level (Odo et al., 2023). The nature of food consumption generally has positive income elasticity. The nature of carbohydrate food consumption is interrelated. This relationship can be known through cross elasticity which describes the percentage change in the amount of commodities demanded (Rozi et al., 2023). Through cross elasticity, the direction of changes in consumer preferences can be determined when the price of one of the carbohydrate-source food commodities increases (Mulyaningtiyas & Supriyono, 2024a). This can happen either due to internal factors such as reduced foreign exchange or external factors such as limited supply in the international market (Panunggul et al., 2023). In Indonesia, according to the Center for Agricultural Data and Information Systems of the Ministry of Agriculture (Pusdatin Kementan 2018),

Commodity Analysis of Carbohydrate Food Availability in the Banyumas Regency Area

in 2018, rice consumption/capita was 81.60 kg, down from 2017 which was 86.82 kg (Qinthara et al., 2024). The data shows that there is a change in the pattern of carbohydrate food consumption from rice to other carbohydrate sources.

The availability of food is indeed very important, especially to meet daily food needs, so an analysis to see the availability of food in Banyumas Regency is indeed necessary, with the condition of the area already densely urbanized, it does not rule out the possibility that farmers can still plant carbohydrates. Research on food availability is always needed from time to time because consumer preferences are always changing following changes in economic capacity and community knowledge (Fatkhan & Chasanah, 2024). One important issue is whether food availability is sufficient to complete the source of carbohydrates in the community, which has never been studied significantly (Qinthara et al., 2024). Analysis of carbohydrate food consumption is very important to provide information in formulating policies related to increasing carbohydrate food consumption (Wijayati & Suryana, 2019b). Therefore, this study aims to analyze the availability of carbohydrate sources on a district scale by considering the future food availability of each sub-district in Banyumas Regency.

II. METHOD

The research method was carried out through descriptive research (Rustamana et al., 2024), the data used in this study are primary data sourced from the service or agency related to the problem being studied. The data obtained in this study are related to the potential and availability of local food sources of carbohydrates, rice, corn, and cassava. This study was analyzed using SPSE food security analysis (Aprianti & Chairuddin, 2024), with the following formula:

$$SPSE = \frac{\{(1-F) \times O - T \times L\} (V \times B \times E) \times 10.000}{U \times 365}$$

Information :

F : Correction factor for feed, losses, industry

O : Production (tons)

T : Correction Factor for Seeds

L : Planted area (ha)

V : Conversion value of paddy to rice = 0.68

B : Edible parts

E : Energy Content

U : Population

There are 3 (three) levels of balance between Supply and Demand:

- Food Security: $S > D$, $SPSE > 1$
- Balanced: $S=D$, $SPSE =1$
- Food Insecurity: $S < D$, $SPSE < 1$

The results of this analysis can describe the availability of non-rice carbohydrate food sources in Banyumas Regency from 2019-2023.

III. RESULTS

Based on the results of the analysis of food security of carbohydrate source foods, the following results were obtained:

Table 1. SPSE Value of Rice Commodity

No.	SUBDISTRICT	PADDY				
		2019	2020	2021	2022	2023
1	Lumbier	0.84	1.61	0.89	0.85	0.85
2	Wangon	1.02	1.04	1.24	1.11	1.04
3	Jatiluwih	1.53	1.58	1.25	0.6	1.58
4	Rawalo	1.56	1.61	1.16	1.61	1.61
5	Basement	0.7	0.9	1.21	1.19	0.9
6	Kemranjen	1.55	1.58	1.47	0.89	1.58
7	Sumpiuh	1.4	1.5	1.43	1.5	1.5
8	Pond	1.79	1.89	1.3	1.89	1.89
9	Somagede	0.6	1.04	1.21	0.76	0.76
10	Kalibagor	1.9	1.58	1.47	1.11	1.11

Commodity Analysis of Carbohydrate Food Availability in the Banyumas Regency Area

11	Banyumas	0.5	1.61	1.43	0.6	0.6
12	The King	1.54	0.9	1.3	1.61	1.61
13	Purworejo	1.1	1.58	1.19	1.19	1.19
14	The Good	0.75	1.5	0.89	0.24	0.89
15	Gumelar	1.22	1.89	1.21	0.11	1.24
16	The Headmaster	1.19	0.9	1.43	0.35	1.25
17	The Climbing	1.13	1.58	1.3	1.47	1.16
18	Karanglewas	1.02	1.5	1.21	1.43	1.07
19	Bullfighting	1.12	1.89	1.47	1.3	1.21
20	Baturraden	1.22	1.04	1.43	1.16	1.47
21	Discordant	1.32	1.61	1.3	0.18	1.43
22	Twins	1.1	0.9	1.3	1.3	1.3
23	Sokara	1.09	1.58	1.16	1.16	1.16
24	South Purwokerto	0.1	1.5	1.19	1.89	0.18
25	West Purwokerto	0.19	1.89	0.89	0.76	0.24
26	East Purwokerto	0.09	0.9	1.24	1.11	0.11
27	North Purwokerto	0.23	1.89	1.25	0.6	0.35

Based on the SPSE analysis that has been carried out on rice commodity production in Banyumas Regency, the SPSE value can be seen in Table 4. The SPSE value is used to determine the level of regional food availability in Banyumas Regency. Based on Table 4, in the last 5 years of rice commodities, namely in 2019-2024, almost every sub-district has a good food security value. In 2019, there were 18 sub-districts that were considered to have good food availability (SPSE > 1), namely Wangon, Jatilawang, Rawalo, Kemranjen, Sumpiuh, Tambak, Kalibagor, Patikraja, Purwojati, Gumelar, Pekuncen, Cilongok, Karanglewas, Kedungbanteng, Baturraden, Sumbang, Kembaran, and Sokaraja Districts. In 2020, there were 22 sub-districts that had good food availability (SPSE >1), namely Wangon, Jatilawang, Rawalo, Kemranjen, Sumpiuh, Tambak, Somagede, Kalibagor, Banyumas, Purwojati, Ajibarang, Gumelar, Cilongok, Karanglewas, Kedungbanteng, Baturraden, Sumbang, Sokaraja, South Purwokerto, West Purwokerto and North Purwokerto. In 2021, there were 24 sub-districts that had good food availability (SPSE >1), namely Wangon, Jatilawang, Rawalo, Kebasen, Sumpiuh, Tambak, Somagede, Kalibagor, Patikraja, Purwojati, Gumelar, Pekuncen, Cilongok, Karanglewas, Kedungbanteng, Baturraden, Sumbang, Kembaran, Sokaraja, South Purwokerto, East Purwokerto, North Purwokerto. In 2022, there were 17 sub-districts that had SPSE values >1, namely Wangon, Rawalo, Kebasen, Sumpiuh, Tambak, Somagede, Kalibagor, Patikraja, Purwojati, Cilongok, Karanglewas, Kedungbanteng, Baturraden, Kembaran, Sokaraja, South Purwokerto, East Purwokerto. In 2023, there will be 18 sub-districts that have good rice food availability (SPSE > 1), namely Wangon, Jatilawang, Rawalo, Kemranjen, Sumpiuh, Tambak, Kalibagor, Patikraja, Purwojati, Gumelar, Pekuncen, Cilongok, Karanglewas, Kedungbanteng, Baturraden, Sumbang, Kembaran, Sokaraja.

Table 2. SPSE Value of Corn Commodity

No.	SUBDISTRICT	CORN				
		2019	2020	2021	2022	2023
1	Lumbier	0.01	0.01	0.02	0.01	0.01
2	Wangon	0.02	0.01	0.1	0.01	0.01
3	Jatiluwi	0.01	0.01	0.01	0.01	0.01
4	Rawalo	0	0	0	0	0
5	Basement	0	0	0	0	0
6	Kemranjen	0	0	0	0	0
7	Sumpiuh	0.02	0.02	0.02	0.02	0.02
8	Pond	0	0	0	0	0
9	Somagede	0.07	0.07	0.07	0.07	0.07
10	Kalibagor	1.3	1.6	2.1	1.4	1.6
11	Banyumas	0.01	0.01	0.01	0.01	0.01
12	The King	0	0	0	0	0

Commodity Analysis of Carbohydrate Food Availability in the Banyumas Regency Area

13	Purworejo	0.01	0.06	0.06	0.06	0.06
14	The Good	0.01	0.65	0.02	0.02	0.02
15	Gumelar	1.5	1.5	0.9	1.4	1.5
16	The Headmaster	0.06	0.02	0.02	0.02	0.02
17	The Climbing	0.02	0.01	0.01	0.01	0.01
18	Karanglewas	0.06	0.01	0.01	0.01	0.01
19	Bullfighting	0	0	0	0	0
20	Baturraden	0.02	0.02	0.07	0.02	0.02
21	Discordant	1.6	1.7	1.4	1.1	1.7
22	Twins	2.0	1.9	1.2	1.3	1.9
23	Sokara	0.01	0.01	0.02	0.03	0.03
24	South Purwokerto	0	0	0	0	0
25	West Purwokerto	0	0	0	0	0
26	East Purwokerto	2.0	3.8	1.4	2.0	3.8
27	North Purwokerto	1.7	3.2	1.7	3.1	3.2

Based on the SPSE analysis in Table 5. It can be seen that there are 6 sub-districts that have an SPSE value of >1 in 2019-2020 and 2022-2023. These sub-districts are Gumelar, Sumbang, Kembaran, East Purwokerto and North Purwokerto. Meanwhile, in 2019 there was a change in Gumelar sub-district, which initially had an SPSE value of >1, in 2019 there was a decrease in production, so that in 2021 the SPSE value was <1. So it can be concluded that based on the SPSE calculation there are 6 sub-districts that have a good level of food availability in 2019, 2020, 2022, and 2023, while in 2021 there are only 5 sub-districts that have a good level of food availability.

Table 3. SPSE Value of Cassava Commodity

No.	SUBDISTRICT	CASSAVA				
		2019	2020	2021	2022	2023
1	Lumbier	1.31	1.49	1.06	1.46	1.49
2	Wangon	0.06	0.27	0.02	0.33	0.27
3	Jatiluwh	0.33	0.54	0.08	0.34	0.54
4	Rawalo	0.27	0.06	0.06	0.26	0.06
5	Basement	1.6	1.6	0.9	1.1	1.2
6	Kemranjen	0.14	0.26	1.49	0.34	0.27
7	Sumpiuh	0.94	0.08	1.49	0.26	0.46
8	Pond	0.16	0.27	0.27	0.08	0.23
9	Somagede	1.94	0.54	0.54	0.94	0.56
10	Kalibagor	0.1	0.06	0.06	0.12	0.34
11	Banyumas	0.26	0.34	0.02	0.02	0.26
12	The King	0.08	0.26	0.08	0.14	0.08
13	Purworejo	1.3	1.3	1.6	1.7	0.0
14	The Good	1.3	1.3	1.0	0.7	0.7
15	Gumelar	1.94	0.06	1.49	0.01	1.94
16	The Headmaster	0.1	0.34	0.27	0.01	0.1
17	The Climbing	0.27	0.54	0.54	0.12	0.38
18	Karanglewas	0.54	0.06	0.06	0.02	0.14
19	Bullfighting	0.06	0.26	0.12	0.01	0.01
20	Baturraden	0.33	0.27	0.01	0.01	0.01
21	Discordant	0.27	0.54	0.1	0.12	0.12
22	Twins	0.46	0.06	0.38	0.02	0.02
23	Sokara	0.14	0.34	0.14	0.14	0.14
24	South Purwokerto	0	0	0	0	0

Commodity Analysis of Carbohydrate Food Availability in the Banyumas Regency Area

25	West Purwokerto	0.01	0.01	0.01	0.01	0.01
26	East Purwokerto	0	0	0	0	0
27	North Purwokerto	0	0	0	0	0

Based on the SPSE analysis in Table 6. There are 6 sub-districts that have SPSE values > 1 in 2019, namely Lumbir, Kebasen, Somagede, Purwojati, Ajibarang and Gumelar sub-districts. In 2020 there are 4 sub-districts that have SPSE values > 1 , namely Lumbir, Kebasen, Purwojati, Ajibarang sub-districts. In 2021 there are 6 sub-districts that have SPSE values > 1 , namely Lumbir, Kemranjen, Sumpiuh, Purwojati, Ajibarang, and Gumelar. In 2022 there are 3 sub-districts that have SPSE values > 1 , namely Purwojati, Kebasen, and Lumbir. While in 2023 there are 3 sub-districts that have SPSE values > 1 , namely Gumelar, Kebasen, and Lumbir sub-districts. So it can be said that the sub-districts that had good food availability in 2019 were Lumbir, Kebasen, Somagede, Purwojati, Ajibarang and Gumelar sub-districts, in 2020, namely Lumbir, Kebasen, Purwojati, Ajibarang, in 2021, namely Lumbir, Kemranjen, Sumpiuh, Purwojati, Ajibarang, and Gumela, in 2022, namely Purwojati, Kebasen, and Lumbir, in 2023 namely Gumelar, Kebasen, and Lumbir. This is in accordance with the withdrawal of the SPSE value decision, if the SPS value ≥ 1 , then an area is said to have sufficient food availability, while if the SPSE value < 1 , then it can be said that an area still does not have enough food.

IV. DISCUSSION

Based on the analysis above, it is known that in the last 5 years, namely in 2019-2024, almost every sub-district has a good food security value. Where this condition makes rice the main commodity. Food availability cannot be separated from the existence of potential natural resources supported by research. In rice cultivation, it is also known as dryland rice cultivation (Khatri et al., 2024). This cultivation is carried out on dry agricultural land such as fields or dry fields which have many irrigation channels, so that the fulfillment of water needs is very significant (Bwire et al., 2024). Although the amount of harvest area, production and productivity are not as large as other regencies, dryland rice can be an alternative pattern of rice cultivation farming which until now is still a source of carbohydrate food that is widely consumed, especially by the people of Banyumas Regency. So it can be concluded that the availability of rice food as a carbohydrate commodity is quite good and is a top priority sector in the planning of economic development of Banyumas Regency.

Corn commodities in Banyumas Regency have a high level of food needs. Corn commodities are the third highest production commodity when compared to other carbohydrate source commodities in Banyumas Regency. Although classified as 3rd, corn is a staple food that is widely used by the community. This condition can be seen from the corn harvest which can be done 4-5 times in well-maintained and good conditions (Mayo & Villarta, 2023). It is often seen that the character of corn plants does not require much water and this plant is very suitable for planting in dry environments, although Banyumas Regency has a rare soil culture in dry conditions, but a good and well-maintained cultivation system actually increases the harvest (Koryati et al., 2022). Not all corn is planted in Banyumas Regency, but farmers choose corn seeds that are cultivated to meet the needs of food sources of carbohydrates for the community, especially rural communities, but are more widely used for mixed or composite materials in animal feed. However, efforts to continue to introduce corn as a non-rice carbohydrate source continue to be carried out by both the government and the private sector. Corn plants require good aeration and drainage so that soil loosening is needed (Utami & Budiningsih, 2015). In general, land preparation for corn plants is done by plowing to a depth of 15-20 cm, followed by harrowing the soil until it is even (Koryati et al., 2022). When preparing the land, the soil should not be too wet but moist enough so that it is easy to work and not sticky (Utami & Budiningsih, 2015). For heavy soil types with excess, it is necessary to make drainage channels, with these results it is concluded that by looking at natural conditions and analyzing corn commodities, it can be used to fulfill good food needs in the Banyumas Regency area.

Until now, some Indonesian people consider cassava to be a secondary crops or second class commodity (Utami & Budiningsih, 2015). Cassava is more widely known, cultivated and processed for the fulfillment of staple foods and snacks. Easy and cheap cultivation techniques are the main considerations for many farmers in Banyumas Regency to choose this plant compared to other types of tubers or others. Moreover, many areas in Banyumas Regency are included in the category of marginal land or dry land, especially the Wangon, Ajibarang, and Gumelar areas. So cassava is very suitable for cultivation both in mass on large land and on a household scale in yards or gardens (Sari et al., 2024). The amount of local food source production shows the amount of food available for household consumption and industry needs (Zaid et al., 2024). With the availability of abundant food, cassava has become an alternative for the community to replace rice carbohydrates, where cassava is very easy to plant and cultivate, even with limited land conditions, you can plant and produce abundant cassava so that cassava in Banyumas Regency has increased from year to year.

Commodity Analysis of Carbohydrate Food Availability in the Banyumas Regency Area

V. CONCLUSIONS

Based on the analysis above, it is known that in the last 5 years, namely in 2019-2023, almost every sub-district has a good food security value. Where this condition makes rice, corn and cassava the main commodities to meet food availability. This condition is seen from the harvest from each year experiencing stability and there are areas that have increased. With these results, it is concluded that by looking at natural conditions and analyzing the right carbohydrate commodities, it can be used to meet good food needs in the Banyumas Regency area.

REFERENCES

- 1) Aprianti, D. I., & Chairuddin, S. (2024). Green Public Procurement Sebagai Salah Satu Implementasi SDGs Sektor Publik Kota Samarinda. *Nusantara Innovation Journal*, 2(2), 137–144.
- 2) Bwire, D., Saito, H., Sidle, R. C., & Nishiwaki, J. (2024). Water Management and Hydrological Characteristics of Paddy-Rice Fields under Alternate Wetting and Drying Irrigation Practice as Climate Smart Practice: A Review. *Agronomy*, 14(7), 1421.
- 3) Farida, S., Elfi, A. S., Damat, D., & Ahmad, W. (n.d.). Potensi Ubi Jalar Ungu (Analisis Kandungan Antosianin).
- 4) Fatkhan, R. A., & Chasanah, U. (2024). Dampak Inovasi Produk dan Digital Marketing Pada Pertumbuhan UMKM: Studi Kasus di Sektor Industri Kreatif. *Socius: Jurnal Penelitian Ilmu-Ilmu Sosial*, 1(12).
- 5) Floresti, D. A., Arifin, A., & Supriadi, D. (2023). Diversifikasi Olahan Ikan Lele Pada Poklahsar Laparama di Desa Karanggintung Kecamatan Sumbang Kabupaten Banyumas. *Darma Sabha Cendekia*, 5(1), 22–31.
- 6) Khatri, P., Kumar, P., Shakya, K. S., Kirilas, M. C., & Tiwari, K. K. (2024). Understanding the intertwined nature of rising multiple risks in modern agriculture and food system. *Environment, Development and Sustainability*, 26(9), 24107–24150.
- 7) Koryati, T., Ningsih, H., Erdiandini, I., Paulina, M., Firgiyanto, R., Junairiah, J., & Sari, V. K. (2022). Pemuliaan Tanaman. *Yayasan Kita Menulis*.
- 8) Mayo, R. E., & Villarta, L. J. S. (2023). Obstacle in Corn Production and the Livelihood Activities of Smallholder Farmers in South Central Philippines. *Open Journal of Social Sciences*, 11(10), 573–586.
- 9) Mkhize, X., Mthembu, B. E., & Napier, C. (2023). Transforming a local food system to address food and nutrition insecurity in an urban informal settlement area: A study in Umlazi Township in Durban, South Africa. *Journal of Agriculture and Food Research*, 12, 100565.
- 10) Mulyaningtiyas, R. D., & Supriyono, S. (2024a). Efektifitas Pengembangan Ubi Jalar Galur Gading Sebagai Sumber Pangan Lokal Unggulan Di Kabupaten Trenggalek. *Manajemen Agribisnis: Jurnal Agribisnis*, 24(2), 334–339.
- 11) Mulyaningtiyas, R. D., & Supriyono, S. (2024b). Efektifitas Pengembangan Ubi Jalar Galur Gading Sebagai Sumber Pangan Lokal Unggulan Di Kabupaten Trenggalek. *Manajemen Agribisnis: Jurnal Agribisnis*, 24(2), 334–339.
- 12) Odo, C. O., Okeke, C. C., & Agu, N. B.-J. (2023). Does the Maslowian Theory of Hierarchy of Needs Explain the Perceived Insurance—Buying Apathy of Nigerians? *Journal of Financial Risk Management*, 12(3), 225–237.
- 13) Panunggul, V. B., Yusra, S., Khaerana, K., Tuhuteru, S., Fahmi, D. A., Laeshita, P., Rachmawati, N. F., Putranto, A. H., Ibrahim, E., & Kamarudin, A. P. (2023). *Pengantar Ilmu Pertanian*. Penerbit Widian.
- 14) Qinthara, F., Kusuma, F. N. D., & Dzahabiyah, S. A. (2024). Potensi Singkong Sebagai Alternatif Beras Menjunjung Diversifikasi Pangan Nasional: Pengaplikasian Singkong Sebagai Bahan Pokok Kampung Adat Cireundeu. *Madani: Jurnal Ilmiah Multidisiplin*, 2(7).
- 15) Rozi, F., Santoso, A. B., Mahendri, I. G. A. P., Hutapea, R. T. P., Wamaer, D., Siagian, V., Elisabeth, D. A. A., Sugiono, S., Handoko, H., & Subagio, H. (2023). Indonesian market demand patterns for food commodity sources of carbohydrates in facing the global food crisis. *Heliyon*, 9(6).
- 16) Rustamana, A., Rohmah, N., Natasya, P. F., & Raihan, R. (2024). Konsep Proposal Penelitian dengan Jenis Penelitian Kualitatif Pendekatan Deskriptif. *Sindoro: Cendikia Pendidikan*, 5(5), 71–80.
- 17) Sari, F. P., Munizu, M., Rusliyadi, M., Nuryanneti, I., & Judijanto, L. (2024). *Agribisnis: Strategi, Inovasi dan Keberlanjutan*. PT. Green Pustaka Indonesia.
- 18) Utami, P., & Budiningsih, S. (2015). Potensi dan ketersediaan bahan pangan lokal sumber karbohidrat non beras di Kabupaten Banyumas. *Jurnal Dinamika Ekonomi Dan Bisnis*, 12(2).
- 19) Wijayati, P. D., & Suryana, A. (2019a). Permintaan pangan sumber karbohidrat di Indonesia. *Analisis Kebijakan Pertanian*, 17(1), 13–26.
- 20) Wijayati, P. D., & Suryana, A. (2019b). Permintaan pangan sumber karbohidrat di Indonesia. *Analisis Kebijakan Pertanian*, 17(1), 13–26.
- 21) Zaid, S., Palilati, A., Madjid, R., & Syaifuddin, D. T. (2024). *RANTAI PASOK PANGAN*. Uwais Inspirasi Indonesia.

The Asean Action towards the Impact Trade War between The Us and China



Cheah Chang Jiang¹, Noraini Zulkifli²

¹Department of International Relations, Security and Law,

²Faculty of Management and Defence Studies, National Defence University of Malaysia

ABSTRACT: The trade war between the United States (US) and China has significantly impacted the Association of Southeast Asian Nations (ASEAN), posing a direct threat to its diplomatic and economic structures. The aim of this study is to study the impacts of Trade War between US and China towards the ASEAN. By employing a qualitative method, secondary data was collected from scientific materials such as books, papers, journals, and online sources. The study utilizes the concept of national interests to explain the phenomenon under investigation. The research highlights that ASEAN has begun taking actions to mitigate the drawbacks of the trade war while maximizing the benefits it brings. These actions include promoting regional economic integration, developing local businesses, strengthening internal cooperation within ASEAN, and diplomatic efforts externally.

KEYWORDS: ASEAN, China, Cooperation, the US, Trade War

INTRODUCTION

ASEAN has made various efforts in responding to the US-China trade war. These efforts encompass external diplomatic measures, the establishment of economic special zones, assistance to local businesses, and the enhancement of internal cooperation within ASEAN. Notably, ASEAN has sought to promote regional economic integration and strengthen cooperation within the ASEAN Economic Community (AEC). Under the AEC framework, ASEAN has improved its competitiveness in international markets and bolstered its overall economic position. Additionally, ASEAN member states are encouraged to support local businesses through measures such as investment attraction and favorable policies. Given the context of the trade war, where the global economy has been significantly impacted, cooperation within ASEAN is crucial to achieve mutual benefits. Strengthening this cooperation ensures a unified voice within ASEAN, particularly concerning the US-China trade war. ASEAN has also consistently focused on resolving the US-China trade conflict through diplomatic means. The trade war between the US and China has had a significant impact on the global economy, especially in the ASEAN region (Mehmood & Khan, 2021). However, behind this impact lies a tremendous opportunity for the overall economic development of ASEAN. While this backdrop has led to a sluggish global economy, ASEAN has effectively seized this opportunity to vigorously boost its local economies. This action has not only driven local economic growth but has also attracted a substantial amount of foreign investment into ASEAN. The influx of foreign investment has provided ASEAN with additional capital to foster the growth of local businesses (Giovanni, 2020). This strategy reflects the resilience and adaptability of the ASEAN region in the face of economic challenges. By capitalizing on the opportunities presented by the trade war, ASEAN has demonstrated its ability to navigate global economic shifts and harness them for its own development. It is a testament to the region's potential and its capacity to attract investment and encourage local entrepreneurship.

PROMOTING REGIONAL ECONOMIC INTEGRATION

Promoting regional economic integration was one of the goals of ASEAN's founding in 1967 (Baviera, 2020). The term "regional economic integration" describes the process of integrating the economies of two or more nations or regions through trade and economic policy development, including the signature of trade agreements or treaties. Economic integration is a useful tool for achieving fiscal policy consensus and is particularly useful in lowering or eliminating trade barriers between nations. Since its inception, ASEAN has, with the efforts of its member states, taken various measures and mechanisms to promote regional economic integration in the ASEAN region (Cerutti et al., 2019). One of the outcomes of ASEAN's efforts to promote regional

The Asean Action towards the Impact Trade War between The Us and China

economic integration is the ASEAN Economic Community (AEC). After the US initiated a trade war against China, the country, which had been providing many manufacturing services to the international market, suddenly faced various issues due to American sanctions. ASEAN immediately simplified the tariff system among its member countries through the AEC organization (Liu, 2018). This move can significantly attract manufacturers who are forced to move out of China to develop within ASEAN. If ASEAN successfully captures these manufacturers relocating from China, it can greatly boost its economic growth.

AEC continued its efforts to promote regional economic integration during the US-China trade war. ASEAN member states, in response to the trade war, remained committed to reducing intra-regional trade barriers (Lighthizer, 2021). They worked on simplifying customs procedures and lowering tariffs to facilitate trade among member countries. Simplifying customs procedures is essential because time is money (Felbermayr & Steininger, 2019). If goods spend too much time in customs, it can result in additional costs, which is detrimental to both businesses and customers. Furthermore, bureaucratic inefficiencies within certain agencies can raise production costs and lead to a decline in product quality. Lowering tariffs is also necessary. Reduction in tariffs can decrease manufacturing costs and attract more domestic and foreign investments to set up factories in ASEAN.

Regional economic integration allows countries to achieve market diversification (Richter, 2020). When a trade war affects a major trading partner, countries can rely on their integrated regional partners to maintain trade flows. This reduces their vulnerability to disruptions in any single market. In this context, while the US-China trade war impacted China's manufacturing sector, ASEAN member states could still rely on their integrated regional partners to sustain trade. When ASEAN member states engage in economic cooperation, they can have greater economic and negotiating power in the global market (Visentini & Thudium, 2021). ASEAN has its own identity and ASEAN are stronger as an ASEAN Community than as a single country (Itakura, 2019). ASEAN as a community have an enhanced role and voice internationally. Regional economic cooperation can enhance ASEAN's international influence and allow it to take a more proactive stance on many issues. This will create a more unified market within the region and reduce trade barriers among member states. As a resilient Community ASEAN help each other adapt and respond to social and economic vulnerabilities, disasters, and climate change

(Krugman, 2022). This particularly highlights the economic vulnerability faced by ASEAN. Against the backdrop of the trade war and a sluggish global economy, ASEAN must find ways to minimize the impact of the trade war on the world, especially on ASEAN member countries.

ASEAN should also consider establishing economic zones with tax exemptions or incentives. These economic zones can further attract domestic and foreign manufacturing investments. These preferential policies can be established through agreements among ASEAN member countries. Creating economic zones with favourable tax and regulatory conditions can stimulate development and trade throughout the region. Such initiatives can enhance the competitiveness of ASEAN member states, attract foreign companies, provide more employment opportunities, and promote local economic development (Ziavrou et al., 2022). However, ASEAN member states should carefully consider the specific details of the zones to ensure that these policies do not undermine fiscal stability or distort markets. This requires a careful balance to ensure that zone policies both attract investment and safeguard the economic health of the country (Lau, 2019). The trade imbalance between China and the US was one of the primary causes of the trade war (Liu & Qiu, 2016). As a major economic bloc, ASEAN can help address the US-China trade deficit, even though it is not the root of the problem. Even though it might not have a significant impact, there are things that can be done to assist in putting an end to the trade war, which has an effect on the world economy. By encouraging regional trade, ASEAN members can lower the trade deficit between the US and China (Lau, 2019). ASEAN member countries can increase their exports to China and the US by facilitating trade, improving connectivity, and fostering trade cooperation.

The main solution to trade deficits is achieving trade balance and transferring trade deficits. As a third party, ASEAN can work on transferring trade deficits to reduce the US-China trade deficit. As a third-party bloc, ASEAN can adjust its imports and exports with the US and China (Lighthizer, 2021). This can help reduce the US-China trade deficit and ease tensions. In simpler terms, ASEAN can increase its imports of US products and reduce its imports from China, if US products meet quality and availability standards. Reducing imports from China also helps reduce overreliance on Chinese products. ASEAN can also shift the trade deficit from the US and China to the ASEAN region. This can be achieved by promoting manufacturing and encouraging US companies to choose ASEAN over China for trade, effectively reducing the US-China trade deficit (Krugman, 2022). Increasing trade with the US can help ASEAN expand into new markets.

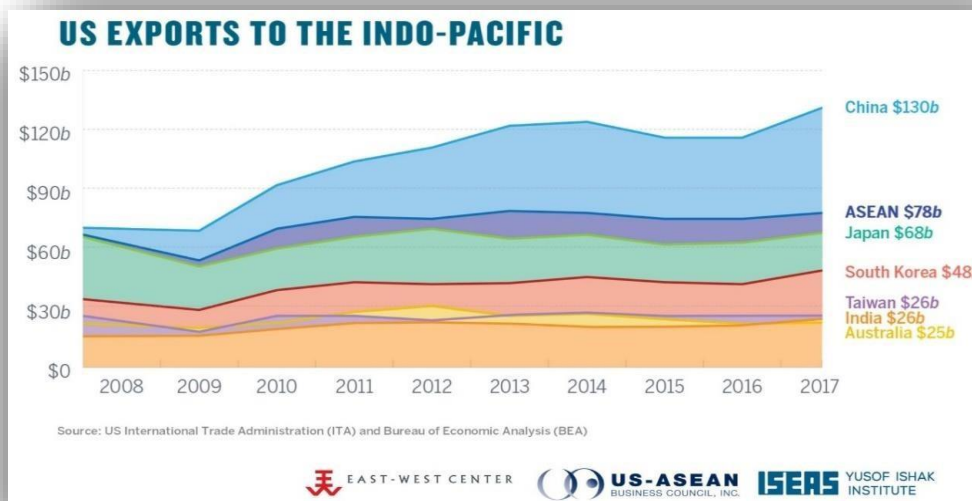

Figure 1.1: The US exports to the Indo-Pacific from 2008 to 2017.

Source: US-ASEAN Business Council (2019) <https://www.usasean.org/why-asean/trade-and-investment>

Figure 1.1 depicts US exports to the Indo-Pacific region from 2008 to 2017. In 2017, US exports to ASEAN amounted to \$78 billion, making ASEAN the second-largest export destination for the US in the Asia-Pacific region and the fourth-largest goods export market overall. The US exported a total of \$75 billion in goods and \$31 billion in services to ASEAN, experiencing a growth of 59% over the decade. During this period, bilateral trade between the US and ASEAN increased by 28%, rising from \$177 billion to \$227 billion. ASEAN maintained a goods trade surplus of \$91 billion with the US, while the US held a services trade surplus of \$10 billion with ASEAN.

DEVELOP LOCAL COMPANY

ASEAN member states should vigorously promote the development of local businesses (Chad, 2018). During the US-China trade war, many Chinese companies faced sanctions, and some were restricted from exporting. China, as a crucial component of the global supply chain, undoubtedly had a significant impact on global manufacturing, including in ASEAN member states (Ha & Lars Willnat, 2022). Therefore, ASEAN member states must strongly support local businesses at this time so that they can, to some extent, replace China in the global supply chain. This can reduce ASEAN's excessive dependence on China's manufacturing sector. Excessive reliance on a single major trading partner, such as China, can make ASEAN member states highly vulnerable to the policies of China. Most of the world's manufacturing is concentrated in China, often referred to as the "world's factory" (Mehmood & Khan, 2021). ASEAN needs to support local manufacturers and simultaneously attract foreign investors to invest in the region. The US-China trade war has indeed contributed to the growth of ASEAN's manufacturing sector (Weixing, 2018). ASEAN's excellent geographical location and skilled workforce make it well-suited for mid-to-high-end manufacturing. While ASEAN currently may not have the direct capacity to replace China's crucial role in the global manufacturing chain, its potential is significant enough to attract a substantial portion of manufacturing away from China. The ongoing US-China trade war presents a rare opportunity for China's manufacturing to shift to ASEAN (Ziavrou et al., 2022). ASEAN must be prepared to welcome and attract these manufacturing industries relocating from China. If ASEAN can effectively seize this opportunity, it can significantly boost the region's overall economy and even enhance ASEAN's global influence.

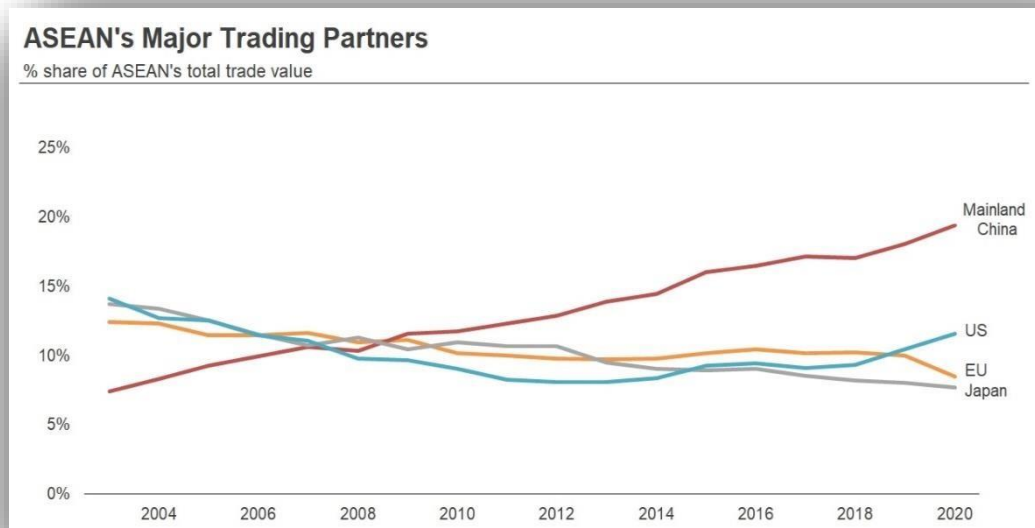

Figure 1.2: The ASEAN’s major trading partners from 2004 to 2020. Source: ASEAN States (2020)

Figure 1.2 illustrates the major trading partners of ASEAN from 2004 to 2020. In 2009, China surpassed the rest of the world to become the largest trading partner of ASEAN. According to statistics from the ASEAN Secretariat, China accounted for a quarter of ASEAN's external trade (24.7%, a significant increase from 15.3% in 2009), with a total trade volume of \$516.9 billion. In 2019, ASEAN surpassed the 27 member states of the European Union (EU-27) to become China's largest trading partner for the first time, contributing to 14.7% of China's total trade. Since 2009, mainland China has surpassed the US and Europe to become the largest trading partner of ASEAN. China, near ASEAN, has experienced robust economic growth, establishing a long-term and stable bilateral trade relationship. Following the signing of the "China-ASEAN Comprehensive Economic Cooperation Framework Agreement" in 2002, the China-ASEAN Free Trade Area was officially launched in 2010, marking China's first negotiation of a free trade area with a foreign entity (Petri & Plummer, 2020). With the reduction of tariffs and liberalization of investment markets resulting from these measures, bilateral trade between China and ASEAN has rapidly expanded.

ASEAN needs to vigorously develop its local businesses. Over-reliance on another economy can expose an economy to various constraints (Jack, 2022). China, being the largest trading partner for ASEAN, has facilitated significant imports and exports between ASEAN countries and China. However, in the event of disruptions in international relations, there is a high likelihood of trade being terminated, posing a potentially fatal blow to ASEAN. ASEAN should enhance its own supply capabilities and actively seek markets beyond China to avoid excessive dependence on the Chinese economy (Ha & Lars Willnat, 2022). Vigorously developing local businesses can also promote the growth of the local economy. The development of local businesses can stimulate economic growth, create job opportunities, and contribute to the overall prosperity and stability of a country (Lau, 2019). When the basic needs of the people are met, and there are rewarding employment opportunities, a country can move towards prosperity and stability. However, when people struggle to meet their basic needs, it can lead to social unrest. Therefore, the development of local businesses is crucial. Additionally, ASEAN should focus on education to cultivate a skilled workforce (Liu, 2018). By training more skilled labour, countries can enhance manufacturing capabilities, producing higher value and higher quality products. This reform is necessary as ASEAN countries should shift from low-end manufacturing to mid-range and even high-end manufacturing. High-end manufacturing is less easily replaceable by manufacturing from other regions and can bring substantial income to the country (Choi & Mun, 2019). While ASEAN is nurturing more technical talents, it can also increase investment and encourage research and development (R&D) activities. R&D activities can promote innovation and the adoption of technology in the manufacturing process (Khuong, 2020).

Additionally, governments can provide a platform for universities, research institutions, and the private sector to establish strong partnerships. ASEAN can also foster collaboration among related manufacturers, such as having components of a mobile phone produced in different ASEAN member countries and then transported to one ASEAN member country for assembly and sale (Chad, 2018). This can significantly enhance production efficiency and product quality. ASEAN should indeed seize the opportunity presented by the US-China trade war. The trade war has led to many foreign investments and foreign companies relocating out of

The Asean Action towards the Impact Trade War between The Us and China

China to mitigate the impact of the trade war (Alee, 2019). If ASEAN can successfully attract these foreign investments and companies to invest in and develop local businesses within the region, it would be highly beneficial (Kapustina et al., 2020). These foreign companies can provide local businesses with much-needed capital to venture into mid- to high-end manufacturing. Furthermore, with effective policies in place, these foreign investments can generate significant returns for the entire ASEAN region.

Each member state in ASEAN, particularly Vietnam, Malaysia, and Indonesia, has immense potential. By effectively harnessing this opportunity, ASEAN can stimulate economic growth in the surrounding regions as well (Alee, 2019). ASEAN can also offer tax incentives, subsidies, and other economic support to attract and retain local manufacturing businesses (Zeng et al., 2022). The most used incentives to attract manufacturing businesses are tax reductions and financing. The focus should primarily be on providing financial support and financing channels for local manufacturing enterprises, especially small and medium-sized enterprises (SMEs). This can enable these small businesses to expand their manufacturing operations, contributing significantly to the overall income of ASEAN (Abiad et al., 2018).

Trade war between US-China, was significant increase in FDI in ASEAN. This indicates that ASEAN indeed has tremendous potential. By actively supporting local businesses, FDI can continue to increase. ASEAN needs to cultivate relationships with multinational companies to integrate local manufacturing into the global supply chain. ASEAN can facilitate cooperation between local and foreign companies, providing opportunities for local businesses to enter global markets and enabling technology transfer (Stromseth, 2020). ASEAN should also assist local manufacturers, whether they are large or small enterprises, in expanding their export markets and gaining international opportunities. ASEAN needs to provide a platform for them to access international customers (Lam & Nguyen, 2019). Supporting trade promotion activities and trade agreements is crucial. Ensuring compliance with international quality standards and certifications is essential to enhance the competitiveness and reputation of local products (Setiawan, 2020). While foreign markets offer great potential, they often have high product quality requirements. Therefore, governments must ensure that their products meet international standards and are certified by reputable authorities. This will enhance the competitiveness of local products and prevent reputation issues.

ASEAN can indeed strive to enhance supply chain resilience. Regional supply chain capabilities can make ASEAN more resilient to the disruptions caused by trade wars (Setiawan, 2020). Member states need to improve infrastructure, such as necessities like roads and utilities. ASEAN member states can also collaborate, for example, by having certain products produced in Vietnam, then sent to Malaysia for further processing or assembly, and finally exported to international markets. The existence of favourable trade agreements within ASEAN simplifies processes and is advantageous for internal development (Ma, 2023). ASEAN should also focus on improving logistics and transportation networks, including building, or upgrading ports. More ports can facilitate increased trade, especially among ASEAN member states. ASEAN is the world's most populous region, following China and India. Its estimated 660 million inhabitants will account for 8.5% of the global population by 2020. The average age of the ASEAN area is 30.3 years, according to UN "World Population Prospects," which is significantly lower than the average age of mainland China (38.4 years) and Hong Kong (44.8 years). Forecasts by the World Economic Forum indicate that over the next ten years, ASEAN will bring 140 million new consumers to the global market, with an average annual GDP per capita growth of 4%. This growth is attributed to the significant purchasing power generated by a comparatively large number of young people. By 2030, ASEAN is predicted to move up to the fourth largest economy from its current position as the world's fifth largest.

In addition to market demand, the ten ASEAN nations' business environments have significantly improved, winning over investors (Graham, 2023). The region's ease of doing business has steadily increased, according to the World Bank's Doing Business report. Singapore remains one of its top three member nations; Malaysia jumped from 23rd place in 2010 to 12th place in 2020; Indonesia and the Philippines saw tremendous gains, moving up from 122nd and 144th place to 73rd and 95th place, respectively. This indicates that ASEAN has the potential to become a center for global economic development in the future. Therefore, ASEAN must make all necessary preparations to create a favorable investment environment and actively support local businesses. Due to ASEAN's favorable environment, coupled with the current backdrop of the trade war, ASEAN is highly likely to become a new hub for economic development in the future (Khuong, 2020). ASEAN needs to prepare now to embrace the significant changes in the future era. It should also cherish this hard-earned opportunity.

STRENGTHENING INTRA ASEAN COOPERATION

Through the ASEAN Free Trade Area (AFTA), ASEAN has made major efforts to strengthen internal cooperation and promote regional economic integration. In order to create a regional market that serves 500 million people, the original six members of the Asia-Pacific Association (AFTA)—Brunei, Indonesia, Malaysia, the Philippines, Singapore, and Thailand—agreed to remove tariffs in 1992. The promotion of economic integration with regional and international partners, the facilitation of intra ASEAN trade, and the growth of the manufacturing sector are all made possible by the ASEAN Free Trade Area. Supporting multiple multilateral

The Asean Action towards the Impact Trade War between The Us and China

forums, such as the Asia Pacific Economic Cooperation (APEC), the East Asia Summit, and the Regional Comprehensive Economic Partnership (RCEP), it is one of the biggest and most important free trade areas in the world (Andrew, 2020).

The trade tensions between the US and China have caused a global strain on the supply chain, significantly impacting the global economy and manufacturing, including the member countries of ASEAN (Ha & Lars Willnat, 2022). In this situation, ASEAN countries should help each other by adjusting their respective supply chains to maximize the utilization of ASEAN's resources. Mutual adjustment of supply chains is a prudent approach that can reduce dependence on the interruption of the Chinese supply chain (Davis & Wei, 2020). If ASEAN doesn't unite and provide mutual assistance during these challenging times, it is less likely that other parts of the world will extend help to ASEAN. During this period, ASEAN countries should diversify their supply chains (Jack, 2022). By establishing closer trade and production relationships among ASEAN member countries, the dependence on China can be reduced (Weixing, 2018). The trade tensions between the US and China have profound effects on the global supply chain and economy, and as a regional organization, ASEAN needs to take coordinated action to mitigate the negative impacts.

Additionally, the tense trade situation between the US and China has led to a global economic downturn. In this moment, ASEAN member countries should help each other to better cope with the global economic slowdown. Strengthening intra-ASEAN trade is crucial (Visentini & Thudium, 2021). Furthermore, ASEAN can avoid seeking trade cooperation with distant economies. In difficult times, unity and mutual assistance are crucial. ASEAN member countries can collectively address the trade tensions and the global economic downturn by enhancing internal cooperation, thus increasing overall resilience. ASEAN member countries can strengthen trade among themselves by reducing trade barriers, simplifying import and export procedures, and promoting the growth of intra-regional trade (Zhu et al., 2018). This can be achieved through the signing of bilateral or multilateral trade agreements.

ASEAN can also facilitate the free movement of talent within the region, allowing for more flexible allocation of labour resources to meet the industrial needs of each country (Thiel, 2019). Encouraging local businesses in ASEAN member countries to collaborate and form synergies in industrial chains is another strategy. This helps improve production efficiency and enhances overall competitiveness. Through common economic development plans, ASEAN can promote collaboration among its member countries, making joint investments in infrastructure, technological innovation, and industrial upgrading to drive overall economic growth (Li et al., 2020). By fostering a closer economic alliance through strengthened internal cooperation, ASEAN can better withstand the uncertainties brought about by trade tensions and the global economic slowdown.

Simplifying and streamlining regulatory processes is essential for ASEAN member states (Li et al., 2020). Excessive bureaucracy within government agencies can erode the credibility of the entire ASEAN region. Both foreign and local businesses are discouraged from dealing with government bodies that are laden with red tape. Cumbersome paperwork and application processes can drive enterprises away from the ASEAN region. ASEAN must simplify these procedures while ensuring that qualified and quality businesses can thrive within the region (Huang et al., 2017). Increasing the efficiency of government agencies and reducing internal bureaucracy are critical to alleviate concerns of local businesses. ASEAN also needs to foster collaboration between the public and private sectors. The primary objective is to identify and address specific challenges and opportunities in various industries. Encouraging dialogue and partnerships can lead to mutual benefit and win-win outcomes (Mehmood & Khan, 2021).

Strengthening internal cooperation through AFTA and expanding free trade zones or increasing the number of items on the duty-free list can be effective in the current state of international markets, especially amid the US-China trade war. These measures can help boost intra-ASEAN trade, encourage further cooperation, and enhance diplomatic relations among ASEAN member countries (Davis & Wei, 2020). While ASEAN member states generally share common interests and goals in the context of the US-China trade war, each country may have its own priorities and preferences (Finley & Johnson, 2018). Increasing trade and cultural exchanges within ASEAN can foster better understanding and stronger diplomatic ties among member states. Given their geographical proximity and interdependence, such cooperation is crucial for maintaining peace and stability in the region (Li et al., 2020). It is crucial for ASEAN member countries to strengthen their relationships with each other to ensure greater unity within the ASEAN community (Giovanni, 2020). Consistency in the external stance, particularly concerning trade tensions, is essential.

In the face of significant issues, such as the trade war, maintaining a united front and a neutral or carefully considered stance is paramount for ASEAN. While individual member countries may have diverse relationships with China and the US, it is imperative for ASEAN to present a unified external position to avoid division and promote cohesion among its member states (Choi & Mun, 2019).

DIPLMATIC EFFORT

ASEAN's stance in the US-China trade war is to maintain neutrality and emphasize the resolution of issues through dialogue. ASEAN is committed to using dialogue and diplomatic means to address the trade war and the conflicts between the US and China

The Asean Action towards the Impact Trade War between The Us and China

(Soeparna, 2021). Through promoting regional dialogue and stability, ASEAN has played a diplomatic role in addressing the US-China trade war. ASEAN has consistently called for both parties to resolve their issues through dialogue rather than allowing the situation to deteriorate. ASEAN's neutral stance and emphasis on dialogue as a means of resolution represent a constructive diplomatic strategy (Aba, 2021). Maintaining neutrality helps to preserve regional stability and avoid becoming entangled in bilateral disputes. It also creates conditions for the diplomatic resolution of conflicts. If ASEAN were to favor one side, its strategy of seeking a diplomatic resolution would be perceived as biased. By promoting regional dialogue and stability, ASEAN aims to mitigate the negative impact of the US-China trade war on the Asian region, while also fostering economic cooperation and mutual trust (Ng, 2021). ASEAN's call for conflict resolution through diplomatic means is built on the principles of multilateralism (Zhao et al., 2020). Multilateralism emphasizes international cooperation among multiple countries to address international issues through collaboration and negotiation, rather than unilateral actions or confrontation (Egberink & van der Putten, 2020). ASEAN underscores the importance of multilateralism, particularly in the realm of international trade, encouraging countries to adhere to international law and trade rules to uphold global and regional peace and stability. In the context of the US-China trade war, ASEAN promotes conflict resolution through multilateral channels by emphasizing multilateralism. This approach underscores international cooperation, negotiation, and compliance with international trade rules to ensure the peaceful resolution of trade disputes. Multilateralism is an integral part of ASEAN's diplomatic strategy, contributing to the maintenance of regional stability and trust (Setiawan, 2020). Through this approach, ASEAN emphasizes the importance of cooperation and dialogue when dealing with international trade issues (Wang et al., 2020).

ASEAN member countries have expressed concerns about the trade war and its impact on Southeast Asia and the global economy (Felbermayr & Steininger, 2019). ASEAN has repeatedly emphasized on the international stage that the trade war is detrimental to both China and the US, as well as the global economy. They stress the urgency of resolving the dispute through dialogue and negotiation to prevent further ramifications on more people and nations (Chen, 2022). China is the largest trading partner of ASEAN, while the US is the third-largest. Disputes between these two major trading partners have had varying impacts on ASEAN's trade volumes. These diplomatic appeals are essential as they represent ASEAN's stance and convey the message that the trade war affects the global economy, underscoring the need to enter a dialogue phase and find a peaceful resolution (Jack, 2022). Once again, ASEAN urges the US and China to seek a peaceful solution to their trade disputes, emphasizing it as the optimal course of action.

ASEAN is not limited to merely calling for dialogue; it is also actively playing the role of a neutral mediator and providing essential assistance in the context of the US-China trade war (Mehmood & Khan, 2021). Given its geographic proximity to China and extensive trade ties with both China and the US, ASEAN certainly does not want to witness a full-blown conflict between the two superpowers that could ultimately affect the region. As a result, ASEAN has consistently appealed and actively positioned itself as a neutral mediator on various platforms, working to mitigate the impact of the trade war on the global and regional economies. Although ASEAN does not have the power to directly resolve the trade war between US and China, it uses its diplomatic platform to advocate for peaceful solutions, promote economic stability, and strengthen regional cooperation (Abiad et al., 2018). At a time of global trade tensions, ASEAN's diplomatic efforts are critical to maintaining peace, stability, and economic development in the region. ASEAN calls on both sides to resolve issues through dialogue, reflecting its commitment to maintaining peace, stability, and prosperity, and playing an important diplomatic role in regional development (Boylan et al., 2020). ASEAN conducted discussions with dialogue partners such as the US and China to advance collaboration, economic stability, and adherence to global trade laws. In resolving international issues, ASEAN, a significant regional organization, has been a vital mediator and promoter (Giovanni, 2020). Its appeals and initiatives demonstrate a dedication to maintaining multilateralism, cooperation, and stability—all of which are essential for regional and international peace and prosperity. In addition, ASEAN is making a concerted effort to establish itself as an impartial mediator in order to lessen the negative effects of the trade war on the local and international economies (Jack, 2022). Such diplomatic initiatives are advantageous as they support the peaceful settlement of disputes and foster regional and worldwide cooperation.

CONCLUSION

During the trade war between the US and China, the AEC continued its efforts to promote regional economic integration by working on various measures to facilitate trade, attract investment, and enhance economic resilience within the ASEAN region. It aimed to leverage the disruption caused by the trade war to position ASEAN as a more attractive and stable economic partner in the global arena. ASEAN also needs to enhance the capabilities of local businesses. This can help local businesses grow and elevate the overall manufacturing industry in ASEAN. The aim is to fill the significant gap left by China, which has been significantly affected by the trade war and disruptions in the global supply chain. This enormous void requires governments to invest in local businesses and

The Asean Action towards the Impact Trade War between The Us and China

attract investments to the region from companies looking to move out of China. With foreign investments and favourable policies from local governments, the capabilities of local businesses are sure to improve. Furthermore, ASEAN members should strengthen cooperation internally, including economic cooperation and cultural exchanges. During these times of global economic turmoil caused by the trade war, intra-regional support is crucial. By reinforcing collaboration within ASEAN, governments can communicate better to avoid significant differences in their stances on the US-China trade war. Lastly, ASEAN has consistently sought to resolve trade disputes between the US and China through diplomatic means. The world economy, including that of ASEAN, has been impacted to varying degrees by the trade war. To prevent the situation from worsening further, ASEAN is committed to acting as a neutral mediator, further coordinating issues between the US and China, particularly regarding the trade war.

REFERENCES

- 1) Aba, F. X. L. (2021). Institutional Change and Macroeconomic Variables in the ASEAN—Indonesia, Vietnam, and Cambodia: The Effects of a Trade War between China and USA. *Economies*, 9(4), 195. <https://doi.org/10.3390/economies9040195>
- 2) Abiad, A., Baris, K., Bernabe, J. A., Bertulfo, D. J., Camingue, S., Feliciano, P. N., Mariasingham, M., & Mercer-Blackman, V. (2018). The Impact of Trade Conflict on Developing Asia. *SSRN Electronic Journal*. <https://doi.org/10.2139/ssrn.3339178>
- 3) Alee, K. (2019). The US-Sino Trade War: The Bigger Picture. *California State University Maritime Academy*. chrome-extension://efaidnbmnnnibpcajpcgiclfndmkaj/https://scholarworks.calstate.edu/downloads/hm50tt97g?locale=en
- 4) Baviera, A. (2020). China's Relations with Southeast Asia: Political Security and Economic Interests. *Philippine APEC Study Center Network*, 99(17).
- 5) Boylan, B. M., McBeath, J., & Wang, B. (2020). US–China Relations: Nationalism, the Trade War, and COVID-19. *Fudan Journal of the Humanities and Social Sciences*, 14(1). <https://doi.org/10.1007/s40647-020-00302-6>
- 6) Cerutti, E., Gopinath, G., & Mohommad, A. (2019). *The Impact of US-China Trade Tensions*. IMF. <https://www.imf.org/en/Blogs/Articles/2019/05/23/blog-the-impact-of-us-china-trade-tensions>
- 7) Chad, P. B. (2018, June 18). *Statement from the President Regarding Trade with China – The White House*. trumpwhitehouse.archives.gov. <https://trumpwhitehouse.archives.gov/briefings-statements/statement-president-regarding-trade-china-2/>
- 8) Cheng- Chwee, K. (2005). Multilateralism in China's ASEAN Policy: Its Evolution, Characteristics, and Aspiration. *Contemporary Southeast Asia*, 27(1), 102–122. <https://doi.org/10.1355/cs27-1f>
- 9) Choi, S. K., & Mun, T. S. (2019). State of Southeast Asia: US-China Trade War. *ISEAS - Yusof Ishak Institute*. chrome-extension://efaidnbmnnnibpcajpcgiclfndmkaj/https://www.iseas.edu.sg/images/pdf/ASEANFocus%20FINAL_Jan19.pdf
- 10) Davis, B., & Wei, L. (2020). *Superpower showdown: how the battle between Trump and Xi threatens a new cold war*. Harper Business, An Imprint Of Harpercollinspublishers.
- 11) Egberink, F., & van der Putten, F.-P. (2010). ASEAN and Strategic Rivalry among the Great Powers in Asia. *Journal of Current Southeast Asian Affairs*, 29(3), 131–141. <https://doi.org/10.1177/186810341002900307>
- 12) Felbermayr, G., & Steininger, M. (2019). Trump's trade attack on China – who will have the last laugh. *Ifo Institut – Leibniz-Institut Für Wirtschaftsforschung an Der Universität München, München*, 20(1), 27–32. <http://hdl.handle.net/10419/199025?>
- 13) Finley, L. L., & Johnson, M. (2018). *Trumpism: the politics of gender in a postpropitious America*. Cambridge Scholars Publishing.
- 14) Giovanni, C. (2020). The ASEAN Economy un The Regional Context: Opportunities, Challenges, and Policy Options. © *Asian Development Bank*. <http://hdl.handle.net/11540/2271>
- 15) Graham, J. (2023, April 15). *U.S.-China technology cold war heats up as Beijing returns fire*. Investor's Business Daily. <https://www.investors.com/news/u-s-china-trade-war-over-technology-heats-up-what-it-means-for-apple-microntesla/>
- 16) Ha, L., & Lars Willnat. (2022). *The U.S.–China Trade War*. MSU Press.
- 17) Huang, K. G.-L., Geng, X., & Wang, H. (2017). Institutional Regime Shift in Intellectual Property Rights and Innovation Strategies of Firms in China. *Organization Science*, 28(2), 355–377. <https://doi.org/10.1287/orsc.2017.1117>
- 18) Itakura, K. (2019). Evaluating the Impact of the US–China Trade War. *Asian Economic Policy Review*, 15(1), 77–93. <https://doi.org/10.1111/aep.12286>
- 19) Jack, Z. (2022). The U.S.-China Trade War and the Tariff Weapon. *Wilson Center*. chrome-extension://efaidnbmnnnibpcajpcgiclfndmkaj/https://www.wilsoncenter.org/sites/default/files/media/uploads/documents/Zhang_The%20US-China%20Trade%20War%20and%20the%20Tariff%20Weapon.pdf

The Asean Action towards the Impact Trade War between The Us and China

- 20) Kapustina, L., Lipková, L., Silin, Y., & Drevalov, A. (2020). US-China Trade War: Causes and Outcomes. *SHS Web of Conferences*, 73(1), 01012. <https://doi.org/10.1051/shsconf/20207301012>
- 21) Khuong, V. (2020). ASEAN: ASEAN Economic Prospects Amid Emerging Turbulence: Development Challenges and Implications for Reform. *Brookings Institution*.
- 22) Krugman, P. (2022, December 13). Opinion | Why America Is Getting Tough on Trade. *The New York Times*. <https://www.nytimes.com/2022/12/12/opinion/america-trade-biden.html>
- 23) Lam, T. H., & Nguyen, P. (2019). The US-China Trade War: Impact on Vietnam. © ISEAS Yusof Ishak Institute, 102. <http://hdl.handle.net/11540/11697>.
- 24) Lau, L. (2019). *The China-U.S. trade war and future economic relations*. Hong Kong Chinese University Press.
- 25) Lighthizer, R. (2021, October 5). *Robert Lighthizer on the need for tariffs to reduce America's trade deficit*. The Economist. <https://www.economist.com/byinvitation/2021/10/05/robert-lighthizer-on-the-need-for-tariffs-to-reduceamericas-trade-deficit>
- 26) Liu, K. (2018). Chinese Manufacturing in the Shadow of the China-US Trade War. *Economic Affairs*, 38(3), 307–324. <https://doi.org/10.1111/ecaf.12308>
- 27) Liu, Q., & Qiu, L. D. (2016). Intermediate input imports and innovations: Evidence from Chinese firms' patent filings. *Journal of International Economics*, 103(5), 166–183. <https://doi.org/10.1016/j.jinteco.2016.09.009>
- 28) Ma, Y. (2023, February 8). *U.S. trade deficit with China 2019*. Statista. <https://www.statista.com/statistics/939402/us-china-trade-deficit/>
- 29) Mehmood, Z. H., & Khan, R. (2021). Revisiting The Us-China Trade War: A *ernational Relations*, 10(19). <https://doi.org/10.22456/2238-6912.113193>
- 30) Ng, L. (2021, August 13). *A Comprehensive Introduction to Commodity Trade Finance - ICC Guide*. ICC Academy. <https://icc.academy/commodity-tradefinance-guide/>
- 31) Petri, P. A., & Plummer, M. G. (2013). ASEAN Centrality and the ASEAN-US Economic Relationship. *SSRN Electronic Journal*. <https://doi.org/10.2139/ssrn.2319426>
- 32) Richter, F. (2020, February 18). *Infographic: China's Rise to Manufacturing Dominance*. Statista Infographics. <https://www.statista.com/chart/20859/chinese-and-us-share-of-globalmanufacturing-output/>
- 33) Setiawan, B. (2020). Does US-China Trade War Matter on ASEAN Stock Market: Event-study Approach. *Sriwijaya International Journal of Dynamic Economics and Business*, 4(3), 161. <https://doi.org/10.29259/sijdeb.v4i3.16174>
- 34) Soeparna, I. (2021). The Role of The Asean Summit In The Asean Economic Dispute Settlement. *Journal of ASEAN Studies*, 9(2). <https://doi.org/10.21512/jas.v9i2.7771>
- 35) Stromseth, J. (2020). Navigating Great Power Competition in Southeast Asia. *Brookings Institution*. https://www.brookings.edu/wpcontent/uploads/2020/12/9780815739142_ch1-1.pdf
- 36) The State Council Information Office of the People's Republic of China. (2018, July 19). *China and the World Trade Organization*. Sl.china-Embassy.gov.cn. http://sl.china-embassy.gov.cn/eng/zt_1/WTO/
- 37) Thiel, A. (2019). Cheat Me in the Price, but Not in the Goods: Negotiating Imaginaries of Authenticity in Accra's China Trade. *Chinese and African Entrepreneurs*, 25(5). https://doi.org/10.1163/9789004387423_013
- 38) Visentini, P., & Thudium, G. (2021). Austral: 10 Anos De Cooperação Sul-Sul. *AUSTRAL: Brazilian Journal of Strategy & International Relations*, 10(20). <https://doi.org/10.22456/2238-6912.121429>
- 39) Wang, X., Wang, X., Zhong, Z., & Yao, J. (2020). The impact of US–China trade war on Chinese firms: Evidence from stock market reactions. *Applied Economics Letters*, 28(7), 1–5. <https://doi.org/10.1080/13504851.2020.1764477>
- 40) Weixing, H. (2018). *Trump's China Policy and Its Implications for the "Cold Peace" across the Taiwan Strait*. *The China Review*, 18(3), 61–88.
- 41) Zeng, K., Wells, R., Wilkins, A., & Gu, J. (2022). Bilateral Tensions, the Trade War, and US–China Trade Relations. *Business and Politics*, 24(4), 1–31. <https://doi.org/10.1017/bap.2022.8>
- 42) Zhao, X.-X., Wen, J., Wanaguru, S., & Chang, C.-P. (2020). The Impact of Trade Conflict on Monetary Policy in Target Economies. *The Singapore Economic Review*, 1–24. <https://doi.org/10.1142/s0217590821410022>
- 43) Zhu, Z., Yang, Y., & Feng, S. (2018). Trade War between China and US. *Proceedings of the 2018 International Conference on Advances in Social Sciences and Sustainable Development (ASSSD 2018)*, 206. <https://doi.org/10.2991/asssd-18.2018.88>



There is an Open Access article, distributed under the term of the Creative Commons Attribution – Non Commercial 4.0 International (CC BY-NC 4.0) (<https://creativecommons.org/licenses/by-nc/4.0/>), which permits remixing, adapting and building upon the work for non-commercial use, provided the original work is properly cited.

Women Discrimination in Mexico and Impact towards The National Security



Ain Sofea Md Salleh¹, Noraini Zulkifli²

¹Department of International Relations, Security and Law,

²Faculty of Management and Defence Studies, National Defence University of Malaysia

ABSTRACT: Mexico is currently grappling with a humanitarian crisis, particularly affecting its female population, which has the potential to lead to severe consequences such as the degradation of the country. This research aims to study the impact of women's discrimination towards Mexican national security. The objective of this research is to ascertain the specific manifestations of discrimination against women in Mexico, examine the implications of such discrimination on national security, and analyze the proactive measures implemented by the Mexican government and non-governmental organizations in addressing this pervasive issue. The qualitative methodology employed in this study originates from secondary sources and the concept used was national security. The results of this study indicate that discrimination against women in Mexico has been influenced by factors within the political, economic, and social domains. It highlights risks for women in Mexican politics and underscores societal discrimination, particularly affecting Indigenous women. During the COVID-19 pandemic, it intensifies gender-based issues, emphasizing the urgency of addressing inequality in Mexico. The ramifications of women's discrimination in Mexico extend across societal facets, contributing to increased crime rates, societal instability, and heightened poverty levels. In anticipation of these consequences, it is imperative to evaluate the vulnerability of various economic sectors and formulate strategies to mitigate their susceptibility. Collaboration between the government and non-governmental organizations is essential to implement initiatives focused on enhancing adaptation capabilities, fortifying legal frameworks, and providing support to affected communities.

KEYWORDS: Communities, Mexico, National security, Women Discrimination, societal instability.

INTRODUCTION

Mexico, officially known as the United Mexican States, is situated in southern North America and shares its borders with the United States to the north, Belize, and Guatemala to the south. It is bounded by three bodies of water: the Pacific Ocean, the Caribbean Sea, and the Gulf of Mexico. Covering an approximate area of 770,000 square miles, Mexico stands as the thirteenth largest country globally, with a population exceeding 120 million inhabitants. The nation is a federation comprising 31 states and Mexico City, which also functions as the capital (Bada, F. 2018).

According to Ferdinand (2018), the country had a considerable nominal gross domestic product (GDP) of roughly \$1.199 trillion, ranking it 15th in the world. According to a prediction, the country might be the fifth-largest economy in the world by 2050. This robust economy is supported by a diverse range of sectors, including considerable amounts of natural resources throughout the country. The primary natural resources in Mexico include minerals like gold, copper, silver and petroleum. Additionally, the country possesses vast forests that provide timber, and there is fertile agricultural land that contributes to its resource wealth.

Unlike men, women in this region face greater challenges in satisfying their basic needs since they work in low-productivity occupations and earn less income both wage and non- wage. Gender violence is a persistent issue for women throughout the region. A significant number of women in Central America have faced violence during their lives, with approximately half of them experienced it. Shockingly, two out of every three women who are murdered in the region fall victim to femicide, which means they are targeted and killed specifically because they are women. Despite significant increases over the last two decades, women's participation in economic activities of 40% to 49% remains lower than men's which is 79% to 86% (IFAD, 2013).

Women Discrimination in Mexico and Impact towards The National Security

Discriminatory gender norms play a significant role in perpetuating violence against women and girls (VAWG). Gender norms refer to unwritten societal rules and commonly held expectations that prescribe specific behaviors based on an individual's gender. Gender norms (the most prominent of which is machismo) are prevalent in Latin America and impact attitudes and behaviors about VAWG. Machismo associates being a "real man" with dominance, aggression, and pride. A "good woman," on the other hand, is relegated to a reproductive function and is expected to be submissive, pure, and stay at home for care tasks. These masculinity and femininity understandings are critical for understanding gender interactions and family dynamics in Mexico, as well as the drivers of VAWG in this national setting (Meyer & Conroy, 2022).

This research aims to examine the issue of women's discrimination in Mexico and its impact on national security. Women, who are Mexico's largest untapped resource, face significant challenges. Despite their educational achievements matching those of men, only 47% of working-age Mexican women are employed. A majority of working women, nearly 60%, engage in informal employment characterized by limited social protection and low wages. Mexico has a high rate of adolescent pregnancies, and a considerable proportion of young women are neither employed, enrolled in school, nor participating in any training programs, with the number being approximately four times higher than young men in the same situation. Compared to other OECD countries, Mexican mothers, regardless of age, are less likely to be employed (OECD, 2017).

In recent years, there has been a rise in the percentage of women engaged in the workforce in Mexico, but it still trails behind other Latin American nations in this regard (OECD, 2016a). Only 40% of women in Mexico are part of the workforce, and the significant proportion of young women who are neither studying nor working (31% of women under 24 compared to 9% of men in the same age group) indicates that gender disparities begin early in life. Women face underrepresentation across all levels of employment. Despite comprising 46% of university graduates, they hold only 37% of entry-level positions and a mere 10% of executive committee seats. This inequality is even more pronounced in domestic businesses, where, on average, there are 10% fewer women employed compared to international companies operating in Mexico. These statistics demonstrate the discrimination faced by women in Mexico (Kinsey. M & Company, 2018).

LITERATURE REVIEW

In this literature review, two themes will be used. Firstly, discrimination against women and secondly mitigation for women's discrimination.

a. Discrimination against women

Mexico stands out as one of the most unequal nations in Latin America, marked by significant disparities across states and regions concerning education, poverty levels, development, access to basic services, and healthcare (Fuentes & Montes, 2004). These inequalities underscore the necessity for the establishment of a Gender Equality Index in Mexican States (GEIMS) to evaluate and analyze the state of gender equality across different regions. Notably, women constitute 51.3% of the Mexican population, with 94.8 men for every 100 women. Despite certain exceptions, Mexico has traditionally been a society dominated by males, and the influence of machismo remains pervasive in various segments of the country (Tony, 2020). Over the last decade, shifting male and female role patterns have introduced the Spanish term "machismo" into the American language (Basham. R, 1976).

In an article written by Frías. S, (2014), *Structural and Ideological Gender Equality in Mexico*, women's representation in public offices may vary depending on the political atmosphere or the type of election. Mexico has seen a contentious democratic transition in recent years, in addition to the high number of elections held every three years and the non-re-election rule. The passage of mandatory gender quota laws has contributed to a chaotic pattern of female representation in the political sphere, as females tend to occupy substitute positions and have been documented as being forced to resign in favor of substitute men.

According to an article written by Henry & Fraga in 2019, *Gender Equality and Old-age Income Security*, in the case of Mexico, Mexican women are over represented in low- wage sectors and are primarily involved in an informal work. Part-time employment is more common among Mexican women than among men. These gaps during working years contribute to severe gender differences in old-age income security, with far fewer people eligible for contributory pension payouts and generating significantly less income from labor later in life. Closing these gaps would make a major difference in lowering a future economic dependency. Martinez et al. (2021) in a journal of Women in formal and informal labor markets in Mexico stated that a marriage and other forms of union and having children limit women's labor-force involvement. Moms have 5.5% lower employment rates and 6.3% lower hourly wages than childless women. Being a mother is also linked to a lower likelihood of having a paid employment (López et al, 2021). According to studies, women who try to re-enter the work market after having a child, would experience a salary penalty. Besides, women who return to the labor forces after giving birth would also

Women Discrimination in Mexico and Impact towards The National Security

experience the same. Martinez also stated that moms in Mexico have a 4.4 percentage point lower labor force participation rate as compared to childless women.

Gupta J. (2018), in a study written in the Article of *Intimate Partner Violence against Low-income Women in Mexico City and Associations with Work-related Disruptions: A Latent Class Analysis using cross-sectional data*, emphasized the need to address certain social considerations. Specifically, there is a crucial requirement to explore the impact of intimate partner violence (IPV) on the employment outcomes of women in Mexico. Despite making strides towards achieving Millennium Development Goal indicators for gender and women's empowerment, a national survey revealed a 33% prevalence of IPV. Additionally, national data indicated that 37.8% of economically active Mexican women experienced some form of IPV in the preceding year, with higher rates of severe violence observed among women employed outside the home (Indey, G. 2013). Given the limited financial resources and increased reliance on abusive relationships among lower-income women in Mexico, researching the effects of IPV on work becomes particularly pertinent. Moreover, women constitute 51% of the informal self-employed workforce (Gupta et al., 2018).

For its part, it has been stated that cases of gender-based violence against women in Mexico and around the world are the result of systematic violations of human rights and cultural and sociologically deeply rooted conditions within a context of generalized violence and systemic discrimination. Only one frightening fact from the United Nations (UN) reveals the scale of this global phenomenon, one out of every three women has experienced some form of violence during their lives, whether physical, psychological, institutional, or economic. In comparison, 6 out of 10 Mexican women had experienced at least one form of violence (López, G. A. 2019).

b. Mitigation for women's discrimination

Friás, S. (2014) claimed in an article about *gender inequality in Mexico* that women in Mexico are still far from achieving gender equality in the social structure. Nonetheless, the progress is astonishing. In 2005, women had only achieved 26% political equality with males. The gender difference was similar 42% in the business and legal sectors, and 35% in the educational sector. Men and women were still treated differently under the law. In terms of education, both genders were more on the same level still, there was a 35% discrepancy. After seven years, the level of gender equality in Mexico has grown dramatically, from a state average of 43.9% in 2005 to 66.9% in 2012. The legal component has seen the greatest development in gender equality (41.7% in 2005 vs. 69.2% in 2012), followed by the educational dimension (64.8% vs. 82.2%). Gender equality has improved less noticeably in the economic realm (42.4% vs. 49.5%).

The Organization for Economic Co-operation and Development (OECD) noted in 2017, in its report titled *"Building an Inclusive Mexico: Policies and Good Governance for Gender Equality,"* that the Mexican government has taken limited measures to address gender equality issues. The government of Mexico has integrated gender equality as a cross-cutting axis in the National Development Plan and has recently pledged to elevate the National System for Gender Equality between Men and Women to ministerial status. In 2016, the President of Mexico presided over the inaugural meeting of the National System, unveiling key equity initiatives, including enhanced gender mainstreaming in the Federal Public Administration, and reiterating Mexico's commitment to eliminating gender-based violence. The National Women's Institute (INMUJERES) plays a crucial role in supporting and promoting the gender equality agenda.

Centro De Investigation International (2020), in an article *Conceptualizing Feminist Foreign Policy: Notes for Mexico* claimed that since a few years ago, Mexico has emphasized the need to incorporate into all government actions, including foreign policy. The organization of the inaugural World Conference on Women in Mexico City in 1975, where the first standards on gender equality were created in multilateral fora, was maybe the beginning point (The PND 2019). Since then, and in line with Mexico's activism to include a gender perspective in the United Nations (UN) development agenda, particularly the adoption of the Beijing Platform for Action in 1995, multilateral measures have been turned into national policies. The National Commission for Women (CONMUJER) was established inside the Ministry of the Interior in 1998 and was renamed the National Institute for Women (INMUJERES) in 2001, with additional state and local entities following.

In a 2020 article titled *"Gender Equality and the Empowerment of Women for Inclusive Growth in Mexico,"* authored by Gurria, it was highlighted that Mexico has made significant advancements in the pursuit of gender equality and addressing gender disparities. The introduction of gender quotas in the legislature in 2002, reiterated in 2008 and 2014, along with the implementation of the 2015-2018 National Program for Equality between Women and Men (PROIGUALDAD), and the mandate for political parties to actively promote gender parity in nominations and allocate 3% of their ordinary expenditure for women's training, are indicative of the country's commitment to addressing gender imbalances. A key focus in achieving gender equality involves enhancing the representation of women in leadership positions. Mexico has been at the forefront of implementing policies aimed at augmenting women's participation in public life. By the year 2017, women held more than 40%

Women Discrimination in Mexico and Impact towards The National Security

of congressional seats, surpassing the OECD average of 30%.

López, G. A. (2019), in an article discussing *"Femicide and Gender Violence in Mexico: Elements for A Systemic Approach"*, highlights that Mexico formally established a legal framework for women's rights in 2007. This legal framework, specifically aimed at ensuring the right to live free of violence and discrimination, was realized through the adoption of the General Law of Access for Women to a Life Free of Violence (GLAWLFV). The enactment of this law aimed to address the alarming prevalence of violence against women in Mexico, particularly in its extreme manifestation as femicide. The GLAWLFV defines femicide as the intentional murder of women resulting from gender-based violence against them. In other words, femicide involves violent killings driven by misogyny, discrimination, and hatred, wherein perpetrators, whether relatives or strangers, engage in acts of extreme brutality against the victims. This occurs within a context of permissiveness by the State, which is seen as failing in its responsibility to protect the lives and safety of women, either through direct actions or omissions, as noted in the report "Femicide and Impunity in Mexico" by the Observatorio Ciudadano Nacional Del Femicidio (OCNF) in 2012.

"The Generation Equality" article by UN Women in 2021, Generation Equality is the world's premier project to accelerate gender equality funding and implementation. It brings organizations from all walks of life together to catalyze development, lobby for change, and take daring actions. The effort, gathered by UN Women, aims to ensure that the high objectives of the 1995 Beijing Platform for Action on Women's Rights are ultimately understood as well as that the Sustainable Development Goals are met. Generation Equality also attempts to increase public support for gender equality, with a particular emphasis on harnessing young people's energy, activity, and ideas. The Generation Equality Forum, held in Mexico City and Paris in 2021, inaugurated Generation Equality. The Forum launched a 5-year action agenda for gender equality, encapsulated in a Global Acceleration Plan for Gender Equality, which specifies the most crucial steps required to accelerate progress over the next five years. The forum held in Mexico shows how the country and the government itself were trying to solve this issue.

In an article titled *"Rights in Gender Times"* by Nieto (2015), it is asserted that despite persistent violence against women, female involvement in the public sphere in Mexico has experienced significant growth since the 1950s. The advancement of women's political rights has been a gradual outcome of legal reforms propelled by the feminist movement and broader social struggles. Noteworthy among these reforms are changes in electoral tribunal judgments, evolving jurisprudence, and the implementation of gender quotas. A pivotal moment in Mexican legal history occurred with the political-electoral reform of February 10th, 2014, as it mandated political parties to present an equal number of male and female candidates, based on the principles of relative majority and proportional representation, in the Chamber of Deputies, Senate of the Republic, and local legislative bodies. Additionally, as per the law, both the officeholder (propietario) and the deputy substitute (suplente) must belong to the same gender.

In a 2002 article titled *"Mexican Women Still Face Discrimination, despite Significant Steps"* by Committee Told, Patricia Espinosa Torres, the President of the National Institute for Mexican Women, extended a welcome to all and presented a film prepared by the National Women's Institute. As depicted in the film, the Institute was the outcome of decades of dedicated efforts by Mexican women and had acquired the status of a decentralized Federal Government agency under the current government. The Institute, during this period, conducted 54 public consultations and formulated the National Program for Equality of Opportunity and Non-discrimination against Women (Proequidad). It further organized 72 events and engaged in discussions with individuals responsible for implementing gender policy in various state ministries. The Institute sponsored training and development courses and provided guidance to facilitate the inclusion of a gender perspective in the plans and initiatives of the Ministry of Health and the Political Development Directorate of the Ministry of the Interior.

In Marin's work from 2023, titled *"The EU as A Gender Equality Actor in Mexico: An Active Agent with A Potential for Further Engagement,"* it is suggested that the European Union (EU) has solidified its position as a global influencer in the realm of human rights. Notably, the EU and Mexico engaged in negotiations for the Global Agreement, a modernized version of their Free Trade Agreement (FTA). An 'agreement in principle' was reached on April 21, 2018, and the finalization of negotiations for a modernized trade component occurred on April 28, 2020. This collaboration led to the formalization of a strategic partnership and the signing of a free trade agreement between the EU and Mexico. These agreements set the stage for various dialogues, including the Joint Parliamentary Committee and the High-Level Dialogue on Human Rights, serving as platforms for exchanging ideas and best practices in pursuit of gender equality. Additionally, the EU actively supports numerous projects in Mexico aimed at assisting the country in advancing its goals for gender equality.

Ngo's Promoting Gender Equality in Mexico by Tri Truong (2021) announced that for non-governmental organizations, few agencies have been established to aid this matter. Firstly, Fondo Semillas ("Seeds Fund") is a Mexican non-profit feminist organization. The organization's ultimate goal is to build an equal country in which women have the ability to make their own decisions. Fondo Semillas attempts to mobilize domestic and international resources. It seeks institutional, corporate, and

Women Discrimination in Mexico and Impact towards The National Security

individual contributions to accomplish this. Secondly, Las Libres is a feminist organization whose principal goal is to promote women's human rights and to demand that women's rights be respected across Mexico. The organization's main goal is to give women access to legal and medical services. It also emphasizes the empowerment of indigenous, uneducated, or low-income women.

CONCEPTUAL FRAMEWORK

In this research, the national security concept will be used. The phrase "national security" is one that is relatively recent. Its features can be seen in Madison's works, and more recently in Walter Lippmann's 1943 work "US Foreign Policy." It was not until World War I that the term "national security" secured a position in the "strategic" vocabulary alongside terms like military affairs, external and military policy, and more. Even at the current level of social development, the phrase national security is usually associated with a sovereign nation-state in the sense of physical integrity protection. This is evident in many of the ways that "national security" has been defined in the social science literature.

Dimitrijević, V (1973) has listed the following five characteristics as the fundamental components of national security. Firstly, maintaining the existence of the state as a political community, the existence of the country (which is not the same as the existence of a specific state), and the physical survival of its citizens. Secondly, defending territorial integrity as a fundamental right of the state. Thirdly, preserving political independence is an element of the state's globally recognized national status. Next, is by ensuring the citizen's life quality and lastly inclusion of the state's "vital interest" in national security strategy.

Nobilo, M. (1988), an academic delving into the security aspects of contemporary international relations, offers a definition of national security as "a complex interplay involving political, economic, military, ideological, legal, social, and various internal and external factors through which individual states seek to guarantee satisfactory conditions for preserving their sovereignty, territorial integrity, the physical well-being of their population, political independence, and opportunities for equitable and swift social development on an equitable basis" (Grizold A, 1994).

METHODOLOGY

This research paper uses the qualitative method. Secondary data will be mainly used in this paper as the main sources. The data is acquired from published or printed resources such as books as well as online data sources. This includes publicly available publications, scientific e-books, articles, journals, and reports. All secondary data material is essential and necessary for the completion of this research and can be referred to through a trusted website or the National Defense University of Malaysia (NDUM) library. Reliable websites and newspapers for the newest information, thesis including individuals who accomplish studies on the problem addressed, that can be obtained through the public website were also being used as references in this research.

URLs for several websites were used such as <https://www.un.org/en/> for United Nations and <https://nationalinterest.org/> for National Interest. The text analysis approach is the second area of concentration in this work. A clear understanding and the discovery of opposing viewpoints on the subject are both assisted by the approach. The materials used are generally straightforward and informative. E-books, journals, and articles from a variety of sources provided help as the research materials.

DISCUSSION

Women discrimination in Mexico is a deeply entrenched and multifaceted issue that has persisted over decades, manifesting in various forms and impacting the lives of women across the country. Despite legal reforms and international commitments to promote gender equality, Mexico continues to grapple with the pervasive challenges of gender-based discrimination. This discrimination affects women across different facets of their lives, from their personal safety and economic opportunities to their access to education and political representation. Understanding the type, implications of women's discrimination and preventive measures taken in Mexico is essential for addressing not only the immediate concerns of women but also the broader social and economic well-being of the nation.

In the realm of Mexican politics, women encounter substantial obstacles, including instances of violence and economic discrimination. The political sphere frequently exhibits inherent gender bias, creating formidable hurdles for women seeking candidacy or positions of authority. Even initiatives designed to foster women's participation, such as quotas, can provoke resistance and, in some cases, escalate to violence. Kidnapping and physical assault are also threat women may confront. Additionally, economic maltreatment becomes evident as allocated funds intended to support women's leadership

Women Discrimination in Mexico and Impact towards The National Security

development are often diverted for unrelated purposes, despite legislative guidelines.

Furthermore, it is imperative to acknowledge that gender-based economic inequality, frequently recognized as the gender pay gap, endures as a significant and enduring issue of global magnitude. Within the Mexican context, women grapple with a multitude of economic discriminations that impede their progress. These discriminations manifest in several forms, including underrepresentation within the workforce, an obligation to work more extended hours, and the allocation of a disproportionate amount of their time to tasks of lower productivity. Despite notable advancements, the presence of women in managerial and leadership roles, particularly within the healthcare sector, still lags, underscoring a persistent deficiency. This state of affairs necessitates continued efforts to rectify gender-based economic disparities.

Additionally, it is crucial to recognize that women in Mexico bear a substantial and disproportionate load of unpaid household and childcare responsibilities, a burden that constrains their active participation in paid employment. These responsibilities, although vital, limit women's ability to engage fully in the workforce. Gender-based wage disparities are palpable, with women consistently earning less in both the formal and informal economic sectors. This wage gap is further compounded by disparities in educational attainment and the complexities introduced by motherhood, which amplifies these existing disparities. Women encounter considerable challenges in seeking gainful employment and establishing job security, factors that often lead to a higher proportion of women engaging in the informal sector. This informal sector is characterized by lower remuneration and a lack of comprehensive employment benefits, painting a stark picture of gender-based economic inequalities that demand attention and rectification.

In the social sector, discrimination against women in Mexican society spans various aspects, including education, healthcare, and social services. Women, especially those from marginalized communities, face layers of discrimination due to factors like gender, race, ethnicity, religion, disability, and socioeconomic status. Physical violence against women is a significant issue, with high rates of assault, homicide, kidnapping, and sexual violence. A substantial portion of these cases go unreported due to public mistrust in the legal system. Indigenous women are particularly vulnerable to forced sterilization, driven by discrimination, inadequate access to healthcare services, and high rates of illiteracy. In addition, the provision of care for unmarried Indigenous women is insufficient, particularly concerning access to abortion services. Men often have better access to healthcare than women, who also bear caregiving responsibilities and are more susceptible to infections. The COVID-19 pandemic has also exacerbated gender inequality, increasing women's caregiving burdens, especially in informal settlements. There have been protests against femicide, domestic violence, and sexual exploitation, with a notable surge in requests for support during the pandemic, emphasizing the urgency of addressing these issues in Mexico.

Discrimination against women in Mexico has profound impacts across various sectors. In the political arena, limited women's participation hampers inclusive policy decisions, contributing to societal instability. Protests and movements, such as "Ni Una Menos" and International Women's Day Marches, draw attention to gender-based violence and influence political engagement. Such protests can have global implications, affecting perceptions of Mexico and eroding trust in the government. Within the economic sector, the gender wage gap exacerbates poverty among women, with single mothers being particularly affected. The informal workforce, where women are prevalent, faces challenges in accessing pensions and benefits, leaving them financially vulnerable in their later years. These disparities not only perpetuate economic inequality but also hinder overall economic growth by underutilizing the country's human potential, ultimately impeding Mexico's progress and development. It is crucial for Mexico to address these issues comprehensively to ensure a more equitable and prosperous future for all its citizens. Lastly, discrimination's social impact includes driving some women into prostitution due to limited job opportunities, low wages, and financial struggles. Gender discrimination limits education and employment prospects, affecting not only women's economic well-being but also their children's access to quality education. This complex problem also increases the risk of sexually transmitted infections and health issues among children of sex workers, compounding social challenges. Failings in investigating gender-based violence, including femicides, not only violate women's human rights but also have profound societal and economic costs. Addressing these issues is essential for Mexico's progress and the well-being of its population.

The Mexican government has taken significant steps to address gender disparities and promote gender equality. Over the past decade, Mexico has made notable commitments both domestically and internationally to achieve genuine gender equality, including enacting the General Equality Law between Women and Men in 2006 and implementing the National Program for Equality between Women and Men (PROIGUALDAD). These initiatives have placed gender equality at the forefront of the country's goals. Mexico has also established an institutional framework for advancing gender equality, with the 2006 General Law on Equality between Women and Men assigning the federal government the responsibility of designing and implementing gender equality policies. The Institute of the Women of Mexico City (INMUJERES) serves as the primary agency for

Women Discrimination in Mexico and Impact towards The National Security

coordinating these initiatives at federal, state, and municipal levels, with a significant standing within the Executive Cabinet. Various governmental bodies such as Mexico's Ministry of Foreign Affairs, The Ministry of Transportation and Secretariat of Welfare and the Institute of Indigenous Peoples, have implemented measures to support women in every sector, and particularly those facing violence and discrimination. These initiatives underscore the government's commitment to gender equality and the well-being of women.

Non-governmental organizations (NGOs) play a crucial role in advancing gender equality in Mexico. Some prominent NGOs, such as Fondo Semillas, Simone de Beauvoir Leadership Institute (ILSB), Nuestras Hijas de Regreso a Casa, and Las Libres, are actively involved in empowering women and addressing gender-based challenges through advocacy, support, and awareness initiatives. These combined efforts by the Mexican government and NGOs demonstrate a commitment to addressing gender disparities and promoting gender equality, even as challenges persist, highlighting the ongoing need for transformation and advocacy in Mexico.

CONCLUSION

It becomes evident that gender discrimination in Mexico has ramifications that extend across multiple sectors, encompassing political, economic, and social domains, thereby impacting national security. It is noteworthy that other countries may encounter similar issues of discrimination but with varying actors involved. These actors could encompass gender-based discrimination, discrimination against transgender individuals, indigenous communities, or immigrants. Therefore, it is highly advisable that future researchers delve into these specific actors. Drawing from the substantial findings and data generated by this research on the protection of national security in Mexico, Malaysian governmental agencies could leverage this platform to address their own national security concerns related to various forms of discrimination against their citizens. This research could serve as a valuable reference or comparative study for forthcoming research endeavors in Malaysia, facilitating a deeper understanding of the implications of discrimination on national security.

REFERENCES

- 1) Agren, D. (2021, September 20). Ten women and girls are killed every day in Mexico, an amnesty report says. The Guardian. <https://www.theguardian.com/global-development/2021/sep/20/mexico-femicide-women-girls-amnesty-international-report>
- 2) Bada, F. (2018, October 23) What Are The Major Natural Resources Of Mexico? WorldAtlas.
- 3) <https://www.worldatlas.com/articles/what-are-the-major-natural-resources-of-mexico.html>
- 4) Basham, R. (1976). Machismo. *Frontiers: A Journal of Women Studies*, 1(2), 126–143. <https://doi.org/10.2307/3346074>
- 5) Convention on the Elimination of all Forms of Discrimination against Women. (2012). Femicide and Impunity in Mexico. https://www2.ohchr.org/english/bodies/cedaw/docs/ngos/CDDandCMDP_DH_forthesessi on_Mexico_CEDAW52.pdf
- 6) Cultural Survival. (2018). Observations on the State of Indigenous Women's Rights in Mexico Alternative Report Submission Prepared for the 70th Session of the Committee on the Elimination of Discrimination against Women. Observations on the State of Indigenous Women's Rights in Mexico. <https://doi.org/10.1016/j.hgmx.2016.07.004>
- 7) Economic Commission for Latin America and the Caribbean (ECLAC). (2020, November). Violence against children and adolescents in the time of COVID-19 CEPAL. https://www.cepal.org/sites/default/files/publication/files/46486/S2000610_en.pdf
- 8) Escobar, A. O. (2023, April 19). "I Don't Want to Disappear": How Mexico's Criminal Violence Reshapes Women's Lives. <https://www.crisisgroup.org/latin-america-caribbean/mexico/i-dont-want-disappear-how-mexicos-criminal-violence-reshapes-womens-lives>
- 9) Frias, S. M. (2014). Gender inequality in Mexico. ResearchGate. https://www.researchgate.net/publication/272237871_Gender_inequality_in_Mexico
- 10) Gamero, A. J. (2022, January 6). Failings in investigations of feminicides in the state of Mexico violate women's rights. Amnesty International. <https://www.amnesty.org/en/latest/news/2021/09/mexico-failings-investigations-feminicides-state-mexico-violate-womens-rights-life-physical-safety-access-justice/>
- 11) Goldenberg, S. M., Silverman, J. G., Engstrom, D., Bojorquez-Chapela, I., Usita, P., Rolón, M. L., & Strathdee, S. A. (2015, April). Exploring the context of trafficking and adolescent sex industry involvement in Tijuana, Mexico: Consequences for HIV risk and prevention. *Violence against women*. <https://www.ncbi.nlm.nih.gov/pmc/articles/PMC4703414/>

Women Discrimination in Mexico and Impact towards The National Security

- 12) González, Adriana A. (14 June 2016) "Mexican Shelter Supports Young Mothers, Indigenous Culture Rejects Them." Global Press Journal. globalpressjournal.com/americas/mexico/mexican-shelter-supports-young-mothersindigenous-culture-rejects/
- 13) Grizold, A. (1994). The Concept of National Security in the Contemporary World. *International Journal on World Peace*, 11(3), 37–53. <http://www.jstor.org/stable/20751984>
- 14) Gupta, J., Willie, T. C., Harris, C. K., Campos, P. M., Falb, K. L., Moreno, C. E., Olavarrieta, C. D., & Okechukwu, C. A. (2018). Intimate partner violence against low-income women in Mexico City and associations with work-related disruptions: a latent class analysis using cross-sectional data. *Journal of Epidemiology and Community Health*, 72(7), 605–610. <https://doi.org/10.1136/jech-2017-209681>
- 15) Gurria, A. (2020, January 9). Gender Equality and the Empowerment of Women for Inclusive Growth in Mexico - OECD. www.oecd.org. <https://www.oecd.org/about/secretary-general/gender-equality-and-empowerment-of-women-for-inclusive-growth-mexico-january-2020.htm>
- 16) International Research Center (2020). Conceptualizing Feminist Foreign Policy: Notes for Mexico. https://www.gob.mx/cms/uploads/attachment/file/545654/Note_6-Feminist_foreign_policy.pdf
- 17) Krook, Mona Lena and Juliana Restrepo Sanin (2014), "Mapping Violence against Women in Politics", paper presented at the Annual Meeting of the American Political Science Association, Washington, D.C., and August 28-31.
- 18) Londoño, P. a. V., González, M. L. G., Solera, C. M. B., & Paz, P. S. (2021). The exacerbation of violence against women as a form of discrimination in the period of the COVID-19 pandemic. *Heliyon*, 7(3). <https://doi.org/10.1016/j.heliyon.2021.e06491>
- 19) López, G. A. (2019). Femicide and Gender Violence in Mexico: Elements for a Systemic Approach. *The Age of Human Rights Journal*, (12), 158-183. <https://doi.org/10.17561/tahrj.n12.9>
- 20) Marin, S. (2023). The European Union as a Gender Equality Actor in Mexico: An Active Agent with a Potential for Further Engagement. Department of EU International Relations and Diplomacy Studies. https://www.coleurope.eu/sites/default/files/research-paper/EDP_1_2023_Marin.pdf
- 21) Mayoux, L. (2006). Quantitative, Qualitative or Participatory? Which Method, for What and When? <https://www.semanticscholar.org/paper/Quantitative%2C-Qualitative-or-Participatory-Which-Mayoux/a6debc883a45006f54644f4525c869d3d8344b3e>
- 22) Medina Espino, Adriana (2013), "Notes on Violence against Women in the Political Sphere in Mexico", http://archivos.diputados.gob.mx/Centros_Estudio/ceameg/ET_2013/22_NSVM.pdf
- 23) Nieto, S. (2015). Rights in times of gender (of women, feminism, and law). Mexico: Electoral Institute of the State of Mexico. <https://publicaciones.ieem.org.mx/index.php/publicacionesieem/catalog/download/28/22/107-1?inline=1>
- 24) Non-Governmental Organization source. (2017, May 27). Gender Equality in Mexico: How Education NGOs Helped an Organization Flourish. ngosource.org. <https://www.ngosource.org/blog/gender-equality-in-mexico-how-ed-helped-an-organization-flourish>
- 25) Organization for Economic Co-operation and Development (2017), Building an Inclusive Mexico: Policies and Good Governance for Gender Equality, OECD Publishing, Paris. <http://dx.doi.org/10.1787/9789264265493-en>
- 26) Ruiz, C. H., & Wangchuk, R. (2022, March). Unpacking barriers to Mexican women's equal participation in labor https://www.hks.harvard.edu/sites/default/files/WAPPP/Hernandez_Wangchuk_Final_S_YPA.pdf
- 27) Ruiz, L., & Pereznieto, P. (2022, November). Women in formal and informal labor markets in Mexico. https://assets.publishing.service.gov.uk/government/uploads/system/uploads/attachment_data/file/1133717/Query-70-Women-Informal-mexico.pdf
- 28) Statista Research Department. (2023, August 21). Topic: Crime and violence in Mexico. Statista. <https://www.statista.com/topics/6576/crime-and-violence-in-mexico/#topicOverview>
- 29) Tony. (2020). Female quality of life in Mexico. [MexConnect](http://mexconnect.com). <https://www.mexconnect.com/articles/3577-female-quality-of-life-in-mexico/>
- 30) Truong, T. (2021). Fondo Semillas - The Borgen Project. <https://borgenproject.org/tag/fondo-semillas/>
- 31) United Nations Women. (2022, May 25). Indigenous women leaders from across the region gather in Mexico to contribute to the development of the CEDAW General Recommendation on the rights of indigenous women and girls. UN Women – Americas and the Caribbean. <https://lac.unwomen.org/en/stories/noticia/2022/05/lideresas-indigenas-de-toda-la-region-se-reunen-en-mexico-para-contribuir-en-el-desarrollo-de-la-recomendacion-general-de-la-cedaw-sobre-los-derechos-de-las-mujeres-y-ninas-indigenas>

Women Discrimination in Mexico and Impact towards The National Security

- 32) Wilton Jen. "Mexican Politics and Economy: Report Reveals Indigenous Women Sterilized without Consent". PULSAMERICA, 18 Feb. 2013, www.pulsamerica.co.uk/2013/02/mexican-politics-and-economy-report-revealsindigenous-women-sterilised-without-consent/

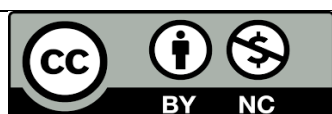

There is an Open Access article, distributed under the term of the Creative Commons Attribution – Non Commercial 4.0 International (CC BY-NC 4.0) (<https://creativecommons.org/licenses/by-nc/4.0/>), which permits remixing, adapting and building upon the work for non-commercial use, provided the original work is properly cited.

Digital Competency Development Among merchant Vocational Education Lecturers: An Analysis of Personal and Institutional Factors Influencing Teaching Effectiveness in Indonesian Higher Education



Suherman¹, Sukirno², Taufik Marjaman³, Pranyoto⁴, Endah Fauziningrum⁵, Kundori⁶, Sukrisno⁷

^{1,2,3,4}Merchant Marine Polytechnic, Singosari Raya No.2A, Kota Semarang, 50242, Indonesia.

^{5,6}Universitas Maritim AMNI, Sukarno Hatta street No. 180 Pedurungan Semarang, 50199, Indonesia

⁷Indonesian College of Tourism Economics Lamongan Tengah bendan, Kota Semarang, 50233, Indonesia

ABSTRACT: This study examines digital competencies among lecturers in Indonesian Maritime Vocational Colleges, aiming to analyze the relationship between lecturer profiles, institutional factors, and digital competency development. The research objectives focus on understanding how personal characteristics and institutional support mechanisms influence digital teaching capabilities while identifying effective strategies for enhancing digital competencies in maritime vocational education. Through a quantitative approach utilizing a comprehensive survey of lecturers across maritime institutions, the study employs DigCompEdu-based measurement tools to assess ten crucial dimensions of digital competency. The methodology combines questionnaires and structured interviews, analyzing data through confirmatory factor analysis and linear regression. Results reveal that while overall digital competency scores are above average on a Likert scale, significant variations exist across different competency domains. Digital tool usage demonstrates the strongest positive correlation with competency development, followed by attitudes toward technology. The study identifies age as negatively correlated with digital competency, while workload shows an unexpected positive relationship. Institutional factors, including curriculum support and professional development opportunities, significantly influence digital competency development. These findings contribute to understanding digital competency development in vocational education settings and provide practical insights for enhancing digital integration in maritime education institutions.

KEYWORDS: Digital Competency, Educational Technology Integration, Maritime Vocational Education, Professional Development, Teaching Digital Competencies (TDC).

I. INTRODUCTION

The educational landscape has witnessed a significant resurgence of digitalization as a central policy focus, particularly within vocational education and training (VET) sectors, where the intricate interplay between economic development and educational advancement remains inseparable. Initial research presented concerning predictions about digitalization's impact on labor markets and workforce dynamics (Bührer & Hagist, 2017; Frey & Osborne, 2013), particularly within the context of the fourth industrial revolution (Brynjolfsson & McAfee, 2014). However, these predicted disruptions have largely given way to a more nuanced understanding of human-machine collaboration, revealing positive complementary interactions that enhance rather than replace human capabilities (Aepli et al., 2017; Pfeiffer, 2018).

The evolution of digitalization from a potential threat to a strategic opportunity has fundamentally reshaped perspectives on maintaining economic competitiveness and educational excellence. This transformation has particularly highlighted vocational education's pivotal role in developing a robust digital economy. Indonesia's experience exemplifies this relationship, as

Digital Competency Development Among Maritime Vocational Education Lecturers: An Analysis of Personal and Institutional Factors Influencing Teaching Effectiveness in Indonesian Higher Education

documented in various policy analyses, showcasing one of the world's most sophisticated VET systems (Bonoli et al., 2018; OECD, 2009). The Indonesian model's distinctive feature lies in its comprehensive integration of school-based and work-based learning pathways, encompassing approximately two-thirds of upper secondary students. This dual system enables apprentices to spend three to four days weekly in corporate environments under professional guidance while completing their academic requirements at vocational institutions.

Significant policy developments emerged through two landmark Indonesian federal government reports in 2017, which emphasized vocational training's crucial role in addressing digital transformation challenges across both public and professional sectors (Indonesian Confederation, 2017a; 2017b). This initiative gained further momentum with the introduction of a specialized VET development program in 2018 (Indonesian Confederation, 2018). The successful implementation of digital transformation strategies necessitates a dual focus on developing both citizen digital competencies (Carretero et al., 2017; Indonesian Confederation, 2019) and professional capabilities.

The evolution of digital competency development in education has undergone significant transformation since the 1980s, when the primary focus centered on infrastructure accessibility. The 1990s marked a pivotal shift toward prioritizing lecturer professional development (Ottestad & Gudmundsdottir, 2018). While environmental and contextual considerations have since expanded the scope of digital integration strategies, lecturer digital competency remains a cornerstone of international educational policy frameworks (OECD, 2019).

Despite the development of various conceptual frameworks and measurement instruments for assessing digital competencies, existing self-assessment tools for educators and institutional leaders (Caena & Redecker, 2019; Ghomi & Redecker, 2019) predominantly target pre-service teachers (McGarr & McDonagh, 2019). Contemporary research increasingly highlights the necessity of expanding investigations beyond basic and lower secondary education contexts (Lucas et al., 2021).

A significant research gap exists in understanding in-service vocational lecturers' digital competencies, particularly within the unique context of VET systems. This environment demands specialized consideration of technology's role in facilitating connectivity between various learning locations and enhancing the integration of school and work-based pathways (Cattaneo, Gurtner, & Felder, 2021; Kilbrink et al., 2020). The diversity of lecturer profiles within these systems suggests varying approaches to digital competency development may be necessary. This research gap extends to understanding how personal characteristics (including age, gender, and technological attitudes) and contextual factors (such as infrastructure availability and institutional support) influence digital teaching competencies (TDC) development, particularly within Maritime Vocational Colleges. The maritime sector's unique technological requirements and rapid digital evolution create additional complexity in developing appropriate digital competency frameworks.

This study addresses these critical research gaps by developing and validating a measurement tool based on DigCompEdu that incorporates VET-specific elements. Through a comprehensive online survey involving 1,692 Indonesian Vocational College lecturers, the research examines the mechanisms through which Maritime Vocational Colleges can enhance their lecturers' digital competencies while identifying key influencing factors in this development process.

The significance of this research lies in its potential to bridge theoretical frameworks with practical implementation strategies in maritime vocational education. By examining both individual and institutional factors affecting digital competency development, this study aims to provide evidence-based insights for policy development and practical implementation strategies in specialized vocational education contexts. The findings will contribute to the growing body of knowledge on digital competency development while offering practical guidelines for maritime vocational institutions seeking to enhance their educational quality through improved digital integration.

II. LITERATURE REVIEW AND DEVELOPMENT HYPOTHESIS

The pivotal role of lecturers as 'true gatekeepers' (Ertmer et al., 2012) in educational digital transformation has emerged as a critical focus in understanding technological integration in education. Digital competency's relevance and influence on educational technology integration (Hatlevik, 2017) has prompted extensive research into identifying factors that enhance its development. These investigations have examined both personal characteristics of lecturers (including age, gender, attitudes, and beliefs) and institutional factors (such as school development and technical infrastructure availability) in relation to digital competencies.

Gender-based differences in digital competency present a complex and sometimes contradictory picture in existing research. While some studies indicate higher digital competency levels among male educators (Almerich et al., 2016; Guillén-Gámez et al.,

Digital Competency Development Among Maritime Vocational Education Lecturers: An Analysis of Personal and Institutional Factors Influencing Teaching Effectiveness in Indonesian Higher Education

2020, pp. 1-18; Siddiq & Scherer, 2019), other research challenges these findings (Krumsvik et al., 2016; Sánchez Prieto et al., 2020; Tondeur et al., 2018). The variability in these results appears to depend significantly on the specific type of digital competency being evaluated (Lucas et al., 2021).

Age as a determinant of digital competency among educators shows similarly complex patterns. Several studies identify age as a significant variable explaining differences in digital competency among lecturers (Hinojo-Lucena et al., 2019; Krumsvik et al., 2016; Lucas et al., 2021), while others find no significant correlation (Guillén-Gámez et al., 2020, pp. 1-18; Tondeur et al., 2018). These varying results may be attributed to differences in sample age distributions across studies. Notably, attitudes toward technology consistently emerge as a positive influencing factor in competency development and technology integration (Ertmer et al., 2012; Tondeur et al., 2018), while increased digital tool usage correlates strongly with higher competency levels (Hatlevik, 2017; Lucas et al., 2021; Tondeur et al., 2018).

The vocational education context presents unique considerations, particularly regarding lecturer workload and professional engagement. Many vocational lecturers maintain parallel professional careers alongside their teaching responsibilities (Vokasi et al., 2002, Clauses 45-46, 47; Boldrini et al., 2019), introducing workload as a potentially significant variable affecting digital competency development. This factor, notably absent from previous research focused on general education teachers, merits particular attention in the vocational education context.

Research on Teaching Digital Competencies (TDC) has traditionally emphasized individual factors while relatively neglecting institutional variables. Despite the acknowledged importance of technological infrastructure and institutional support for TDC development in facilitating pedagogically competent digital technology use in teaching and learning, research examining the impact of organizational infrastructure, leadership support, and institutional digital development on TDC remains limited (Pettersson, 2018).

Existing research presents conflicting evidence regarding the relationship between institutional digital infrastructure and technology utilization. Some studies suggest that the availability and quality of school digital infrastructure (including classroom equipment, internet access, and computer availability) show no significant correlation with technology usage (Gil-Flores et al., 2017) or TDC (Lucas et al., 2021). However, Lucas et al. (2021) identified significant effects of student technology access on all evaluated digital competencies and positive effects of curricular support on specific digital competencies related to learner empowerment and digital competency facilitation.

Based on these research findings and gaps, two primary hypotheses emerge:

H1: A significant relationship exists between lecturer profiles and digital competencies, with lecturers active in general education potentially scoring higher in areas related to student digital competency development compared to their colleagues in other fields.

H2: Workload represents a significant factor in digital competency development, with part-time lecturers potentially demonstrating lower TDC levels compared to their full-time counterparts.

III. METHOD

We chose Maritime Vocational Colleges in Indonesia to test our proposed model for several compelling reasons. Firstly, these institutions represent critical centers for developing maritime professional competencies, operating under the Ministry of Transportation's Directorate General of Sea Transportation. Specifically, we selected STIP JAKARTA, PIP MAKASSAR, PIP SEMARANG, and POLTEKPEL SURABAYA as our research locations. These institutions were chosen because they exemplify the current challenges and opportunities in integrating digital competencies within vocational education.

The selection of these institutions was motivated by several key factors. First, these institutions represent pure vocational education establishments, where the integration of technology with practical training is particularly crucial. Second, there is a notable gap in lecturers' contributions to effective technology integration in education at these institutions. Additionally, these institutions face challenges regarding attitudes and beliefs toward technology use in learning, technological proficiency and confidence levels, and the availability and accessibility of hardware, software, and infrastructure.

Furthermore, the selection of these maritime vocational colleges is expected to provide evidence of how teaching practices have yet to fully implement the concept of "pedagogy will skill tool," particularly in practical pedagogical applications. This aspect is especially relevant given the unique demands of maritime education, where digital competency directly impacts both classroom instruction and practical training outcomes.

To determine the sample size for this study, we followed Hair et al.'s (2006) methodology, which states that for structural equation modeling with five or more constructs, the minimum sample size should be 100. To achieve a statistical power level of

Digital Competency Development Among Maritime Vocational Education Lecturers: An Analysis of Personal and Institutional Factors Influencing Teaching Effectiveness in Indonesian Higher Education

0.95, we adopted Soper's (2006) sample size calculator, considering our five variables with 27 observed indicators and a probability level of 0.05. This calculation indicated a minimum required sample size of 292 (Hair et al., 2006; Soper, 2006).

Our research methodology employed both quantitative. The primary data collection was conducted through questionnaires administered to lecturers at the selected institutions. Additionally, we conducted structured interviews using open-ended questionnaires to provide justification and deeper insights into the closed questionnaire responses.

The implementation of the research took place from January to April 2024, focusing on various technical service units under the Ministry of Transportation's Directorate General of Sea Transportation. The research design employed a quantitative approach to test theoretical frameworks aimed at enhancing lecturers' digital competencies. By conducting the study at these specific institutions, we aimed to capture a representative sample of the maritime vocational education sector in Indonesia, providing insights that could be valuable for similar institutions nationwide. This research methodology design ensures both applicable and researchable outcomes (Zikmund, 2000), addressing both the practical needs of maritime vocational education and the theoretical requirements of academic research. Our approach combines field survey data with structured analysis methods, including univariate normality tests, descriptive statistics, and bivariate correlation analyses, all processed using IBM SPSS Statistics (version 27) predictive analytics software.

Development of measures

Table 1. Results of Confirmatory Factor Analysis (CFA) of Digital Competency Measurement

Digital Competency Items	Factor Loading (λ)	SE	P
Factor 1: Communication and Collaboration			
1.1 Digital technology utilization (email, school website) for student and colleague communication	.842	.010	<.001
1.2 Communication format and channel selection based on audience, context, and learning objectives	.829	.010	<.001
1.3 Digital technology for collaborative work with educational professionals	.813	.011	<.001
1.4 Digital technology utilization for inter-institutional collaboration	.714	.016	<.001
1.5 Digital technology facilitation with VET stakeholders	.743	.017	<.001
1.6 Digital technology facilitation with VET trainers and instructors	.673	.018	<.001
Factor 2: Professional Development			
2.1 Proactive development of digital teaching skills	.844	.013	<.001
2.2 Utilization of digital training opportunities (MOOCs, webinars)	.685	.019	<.001
2.3 Participation in traditional face-to-face technology training	.501	.026	<.001
Factor 3: Digital Resource Selection			
3.1 Internet utilization for digital resource identification	.813	.011	<.001
3.2 Search technique utilization for digital resource alignment	.877	.015	<.001
3.3 Digital resource quality assessment based on relevant criteria	.758	.010	<.001
Factor 4: Digital Resource Creation			
4.1 Adaptation of digital resources based on learning objectives	.767	.014	<.001
4.2 Creation of digital resources for teaching support	.765	.013	<.001
4.3 Collaborative digital resource creation	.684	.017	<.001
4.4 Student involvement in digital learning resource creation	.677	.018	<.001
Factor 5: Data Protection			
5.1 Privacy and data protection regulation compliance	.767	.013	<.001
5.2 Sensitive data protection implementation	.746	.013	<.001
5.3 Copyright compliance and proper attribution	.732	.015	<.001
5.4 Digital privacy maintenance	.810	.011	<.001
5.5 Digital security risk awareness	.760	.014	<.001
5.6 Digital resource access control	.755	.015	<.001
Factor 6: Teaching and Learning			
6.1 Strategic digital technology integration	.635	.017	<.001

Digital Competency Development Among Maritime Vocational Education Lecturers: An Analysis of Personal and Institutional Factors Influencing Teaching Effectiveness in Indonesian Higher Education

6.2 Interactive digital tool implementation	.710	.014	<.001
6.3 Collaborative digital resource utilization	.722	.014	<.001
6.4 Digital innovative teaching strategy development	.826	.010	<.001
6.5 Digital student activity monitoring	.768	.013	<.001
6.6 Digital collaboration facilitation	.824	.010	<.001
6.7 Digital learning reflection tool integration	.756	.012	<.001
6.8 Inter-institutional learning relationship facilitation	.652	.017	<.001
6.9 Theory-practice relationship enhancement	.773	.012	<.001
Factor 7: Assessment			
7.1 Digital student progress monitoring	.845	.010	<.001
7.2 Digital formative assessment support	.874	.009	<.001
7.3 Digital summative assessment support	.846	.010	<.001
7.4 Student data analysis for support identification	.710	.016	<.001
7.5 Digital feedback provision	.776	.012	<.001
Factor 8: Student Empowerment			
8.1 Technical accessibility consideration	.607	.021	<.001
8.2 Alternative technology adaptation	.613	.021	<.001
8.3 Personalized digital learning opportunity provision	.756	.014	<.001
8.4 Customized digital teaching intervention	.748	.014	<.001
8.5 Active student engagement through digital technology	.786	.013	<.001
8.6 Digital resource utilization facilitation	.680	.016	<.001
Factor 9: Media Education			
9.1 Online information evaluation instruction	.729	.016	<.001
9.2 Digital safety education provision	.867	.009	<.001
9.3 Cyberbehavior awareness instruction	.787	.013	<.001
9.4 Digital identity management instruction	.837	.012	<.001
Factor 10: Student Digital Competence			
10.1 Digital communication task design	.770	.012	<.001
10.2 Digital content creation assignment development	.752	.014	<.001
10.3 Creative digital problem-solving promotion	.786	.011	<.001
10.4 Digital learning documentation facilitation	.765	.013	<.001
10.5 External digital collaboration facilitation	.647	.017	<.001
10.6 Professional practice digital documentation	.654	.016	<.001

The confirmatory factor analysis (CFA) revealed ten crucial dimensions of digital competency measurement for lecturers in vocational education: Communication and Collaboration, Professional Development, Digital Resource Selection, Digital Resource Creation, Data Protection, Teaching and Learning, Assessment, Student Empowerment, Media Education, and Student Digital Competence. Each factor demonstrates significant factor loadings (generally above 0.7), indicating strong reliability as measurement indicators. The analysis highlights the multifaceted nature of digital competencies required by lecturers, encompassing both technical and pedagogical aspects. The findings provide valuable insights for developing valid measurement instruments and understanding essential dimensions for enhancing lecturers' digital competencies in educational settings. This structured framework supports the assessment and development of digital teaching capabilities in modern educational environments.

Table 2. Testing hypothesis 1

	Professional subjects (N = 167)		Professional baccalaureate (N = 288)		General education (N = 137)	
	M	SD	M	SD	M	SD
Digital Competence	3.04	0.620	3.13	.623	3.16	0.93

Digital Competency Development Among Maritime Vocational Education Lecturers: An Analysis of Personal and Institutional Factors Influencing Teaching Effectiveness in Indonesian Higher Education

Communication and Collaboration	3.18	0.88	3.09	0.79	3.81	0.37
Professional Development	3.79	0.81	3.03	0.83	3.86	0.44
Digital resources' Selection	3.49	0.83	3.57	0.73	3.56	0.67
Digital Resources' Creation	2.82	0.87	2.68	0.88	2.34	0.63
Data Protection	3.28	0.78	3.49	0.72	3.74	0.86
Teaching and Learning	2.77	0.80	2.02	0.81	2.82	0.90
Assessment	2.30	0.92	2.70	0.89	2.46	0.57
Learners' Empowerment	3.11	0.79	3.16	0.78	3.04	0.60
Learners' Media Education	2.69	0.81	2.71	0.83	3.51	0.87

This comparative analysis of digital competency scores across three teaching profiles (Professional Subject, Professional Baccaulaureate, and General Education) reveals subtle but significant differences. While overall digital competency scores show relatively small variations (Professional Subject: 3.27, Professional Baccaulaureate: 3.12, General Education: 3.14), specific sub-competencies demonstrate notable patterns. General Education consistently scores higher in student-focused areas such as Student Empowerment (3.70), Media Education (3.24), and Student Digital Competence (3.47). Professional Subject teachers excel in Digital Resource Selection (3.69), while Professional Baccaulaureate shows strength in Teaching and Learning (2.97). These variations, though minor, reflect the different curricular focuses and teaching responsibilities across profiles, suggesting the need for targeted professional development while maintaining standardized digital competency requirements in vocational education.

Table 2. Testing Hypothesis 2

No.	Variables	B	SE	T	95% CI	
					LL	UL
1	Gender	-.158***	.039	3.906	-.119	-.086
2	Age	-.088***	.015	4.095	-.104	-.054
3	Workload	.009***	.005	7.109	.007	.078
4	Attitude	.316***	.017	23.705	.382	.698
5	Digital Tool Usage	.762***	.028	24.056	.677	.805
6	Student Access	.218***	.021	12.609	.159	.284
7	Infrastructure	.179***	.028	8.118	.178	.198
8	Curriculum Support	.238***	.022	13.815	.189	.258
9	Professional Development Support	.116***	.069	8.198	.094	.141
10	School Development Progress	.191***	.052	9.597	.109	.174

*Note: $p < .05$; ** $p < .01$; *** $p < .001$; B = unstandardized regression coefficient; SE = Standard Error; t = t-statistic value; CI = Confidence Interval; LL = Lower Limit; UL = Upper Limit. a 0 = male, 1 = female.

The simple linear regression analysis reveals significant influences on teachers' Total Digital Competency Scores. Digital tool usage shows the strongest positive impact ($B=0.762$, $p<.001$), followed by attitude towards technology ($B=0.316$, $p<.001$) and curriculum support ($B=0.238$, $p<.001$). Notably, gender and age demonstrate negative relationships, with female teachers scoring lower than males ($B=-0.158$, $p<.001$) and older teachers showing decreased digital competency ($B=-0.088$, $p<.001$). Infrastructure ($B=0.179$), student access ($B=0.218$), and school development progress ($B=0.191$) all show significant positive influences. While workload has a minimal positive effect ($B=0.009$), professional development support demonstrates moderate impact ($B=0.116$). These findings suggest that institutional support and personal factors significantly influence teachers' digital competencies.

Digital Competency Development Among Maritime Vocational Education Lecturers: An Analysis of Personal and Institutional Factors Influencing Teaching Effectiveness in Indonesian Higher Education

IV. DISCUSSION

The study reveals significant insights into the digital competency levels among vocational education lecturers in Indonesia. With an overall digital competency score of 3.09 on a 5-point Likert scale, the findings align with similar studies conducted in non-VET contexts (Benali et al., 2018; Ghomi & Redecker, 2019; Lucas et al., 2020). The analysis of specific subcompetencies demonstrates that "Digital Resource Selection" achieved the highest average score, while "Assessment" ranked lowest among all competencies.

Gender analysis reveals that female lecturers generally demonstrate lower digital competency scores compared to their male counterparts, with a regression coefficient of -0.158 ($p < 0.001$). Age shows a negative correlation with digital competency ($B = -0.088$, $p < 0.001$), indicating that older lecturers tend to have lower digital competency levels, except in Data Protection competency where age positively correlates with performance (Hinojo-Lucena et al., 2019; Krumsvik et al., 2016).

Workload demonstrates a positive correlation with digital competency ($B = 0.009$, $p < 0.001$), suggesting that lecturers with higher workloads tend to develop stronger digital competencies. This counter-intuitive finding may be attributed to the necessity of utilizing digital tools for efficiency in managing increased responsibilities.

Attitudes toward digital technology emerge as a crucial factor ($B = 0.316$, $p < 0.001$), with positive attitudes strongly correlating with higher digital competency levels (Ertmer et al., 2012; Tondeur et al., 2018). This relationship underscores the importance of fostering positive technological attitudes among lecturers through supportive institutional environments and demonstrable benefits of digital integration.

Digital tool usage shows the strongest positive correlation ($B = 0.762$, $p < 0.001$) with digital competency, emphasizing that regular interaction with digital tools significantly enhances competency development (Hatlevik, 2017; Lucas et al., 2021; Tondeur et al., 2018). This finding highlights the importance of providing opportunities for practical application of digital tools in teaching contexts.

Student access to digital technology ($B = 0.218$, $p < 0.001$) and infrastructure availability ($B = 0.179$, $p < 0.001$) show moderate positive correlations with lecturer digital competency. However, their impact is less significant compared to personal factors like attitudes and usage frequency, suggesting that mere availability of resources doesn't guarantee competency development.

Curriculum support demonstrates a significant positive influence ($B = 0.238$, $p < 0.001$) on digital competency development, indicating that explicit integration of digital technology in curriculum guidelines encourages lecturers to enhance their digital skills. Professional development support ($B = 0.116$, $p < 0.001$) and school development progress ($B = 0.191$, $p < 0.001$) also show positive correlations, emphasizing the importance of institutional support systems.

The findings indicate that maritime vocational education institutions should adopt a comprehensive approach to enhancing lecturer digital competency. This approach should address both individual factors (attitudes, usage patterns, workload management) and institutional factors (infrastructure, curriculum support, professional development opportunities). The development of digital competencies requires a balanced consideration of various factors, with particular attention to fostering positive attitudes toward technology and providing regular opportunities for digital tool usage.

Moreover, the study highlights the need for differentiated support strategies based on lecturer demographics and teaching profiles. Younger lecturers generally demonstrate higher digital competency levels, suggesting the need for targeted support for older faculty members. Similarly, the varying impacts of workload and professional development support indicate the importance of flexible and personalized approaches to digital competency development.

The research underscores that enhancing digital competencies requires more than just technological infrastructure and access. It necessitates a holistic approach that combines personal motivation, institutional support, and practical application opportunities. These findings provide valuable insights for developing effective strategies to enhance digital competencies among vocational education lecturers, particularly in maritime education contexts where digital skills are increasingly crucial for both teaching effectiveness and industry relevance. The study also reveals important insights regarding the relationship between institutional development and lecturer digital competency. The findings suggest that institutions undergoing active digital transformation create environments more conducive to digital competency development. This relationship manifests through several mechanisms:

First, institutions actively pursuing digital transformation typically provide more structured opportunities for lecturers to engage with digital technologies. These opportunities, combined with clear institutional expectations, create a framework that encourages continuous digital skill development. Second, progressive institutions often implement comprehensive support

Digital Competency Development Among Maritime Vocational Education Lecturers: An Analysis of Personal and Institutional Factors Influencing Teaching Effectiveness in Indonesian Higher Education

systems that address both technical and pedagogical aspects of digital integration, leading to more balanced competency development among lecturers.

Furthermore, the study identifies a notable interaction between professional development support and lecturer attitudes toward technology. Institutions providing robust professional development programs tend to see more positive attitudes toward technology among their lecturers, which in turn correlates with higher digital competency levels. This suggests a synergistic relationship between institutional support and individual factors in developing digital competencies. The findings also indicate that successful digital competency development requires alignment between institutional policies, infrastructure development, and professional development programs. When these elements are well-coordinated, lecturers are more likely to develop and maintain higher levels of digital competency, regardless of their initial skill levels or demographic characteristics.

These insights provide valuable guidance for maritime vocational institutions seeking to enhance their lecturers' digital competencies. The research suggests that successful digital transformation requires a multi-faceted approach that addresses both individual and institutional factors while maintaining focus on practical application and pedagogical relevance.

V. CONCLUSIONS

The study's conclusions reveal significant insights into digital competencies among VET lecturers. While age demonstrates a negative correlation with digital competency and gender shows no significant influence, higher workload surprisingly correlates positively with better digital competency. Both personal and institutional factors demonstrate substantial impact on digital competency development. Personal factors, particularly positive attitudes toward technology and frequent digital tool usage, strongly correlate with enhanced digital competency. Similarly, institutional factors including curriculum support, professional development opportunities, and school progress in digital transformation show positive correlations with lecturers' digital capabilities.

VI. IMPLICATION

The research implications span both practical and theoretical domains. Practical implications emphasize the need for tailored training programs that consider age, workload, and current digital competency levels. These programs should incorporate VET curriculum evaluation and revision for broader digital technology integration, supported by adequate technological infrastructure. Institutions must develop a supportive school culture that encourages innovation and technology use while maintaining effective workload management to prevent stress and maintain productivity.

Theoretical implications provide empirical evidence supporting the importance of individual factors in digital competency development. The findings confirm the significance of school environmental factors and support a systems theory approach that links individual and environmental factors. The study offers new insights into the correlation between workload and digital competency, contributing significantly to technology adoption theory in the VET context.

VII. LIMITATION AND FUTURE RESEARCH

The research acknowledges several limitations that should be considered. These include constraints related to sample size and representation, data collection methods, variations in operational definitions, and socio-cultural context limitations. The cross-sectional design of the study also presents limitations in understanding long-term developmental patterns. Looking forward, the research agenda suggests several directions for future studies. These include conducting longitudinal studies to track digital competency development over time, implementing mixed-method approaches for deeper understanding, and including larger and more diverse samples. Future research should focus on developing more sophisticated measurement instruments, analyzing contextual factors, and studying the effectiveness of various interventions. This comprehensive approach to future research will help address current limitations while expanding understanding of digital competency development in VET settings.

REFERENCES

- 1) Aagaard, T., & Lund, A. (2020). Digital agency in higher education. Transforming teaching and learning. Routledge.
- 2) Aepli, M., Angst, V., Iten, R., Kaiser, H., Lüthi, I., & Schweri, J. (2017). Die Entwicklung der Kompetenzanforderungen auf dem Arbeitsmarkt im Zuge der Digitalisierung [The development of competence requirements on the labour market in the course of digitalisation]. Staatssekretariat für Wirtschaft SECO.

Digital Competency Development Among Maritime Vocational Education Lecturers: An Analysis of Personal and Institutional Factors Influencing Teaching Effectiveness in Indonesian Higher Education

- 3) Ala-Mutka, K. (2011). Mapping digital competence: Towards a conceptual understanding. Publications Office of the European Union.
- 4) Alarco'n, R., del Pilar Jim'enez, E., & de Vicente-Yagüe, M. I. (2020). Development and validation of the DIGIGLO, a tool for assessing the digital competence of educators. *British Journal of Educational Technology*, 51(6), 2407–2421. <https://doi.org/10.1111/bjet.12919>
- 5) Almerich, G., Orellana, N., Su'arez-Rodr'iguez, J., & Dia'z-Garcia, I. (2016). Teachers' information and communication technology competences: A structural approach. *Computers & Education*, 100, 110–125. <https://doi.org/10.1016/j.compedu.2016.05.002>
- 6) Andersson, P., & Ko'ps'en, S. (2015). Continuing professional development of vocational teachers: Participation in a Swedish national initiative. *Empirical Research in Vocational Education and Training*, 7(1), 7. <https://doi.org/10.1186/s40461-015-0019-3>
- 7) Benali, M., Kaddouri, M., & Azzimani, T. (2018). Digital competence of Moroccan teachers of English. *International Journal of Education and Development using ICT*, 14(2).
- 8) Berger, J.-L., & D'Ascoli, Y. (2012). Becoming a VET teacher as a second career: Investigating the determinants of career choice and their relation to perceptions about prior occupation. *Asia-Pacific Journal of Teacher Education*, 40(3), 317–341. <https://doi.org/10.1080/1359866X.2012.700046>
- 9) Black, R. A., Yang, Y., Beitra, D., & McCaffrey, S. (2015). Comparing fit and reliability estimates of a psychological instrument using second-order CFA, bifactor, and essentially tau-equivalent (coefficient alpha) models via AMOS 22. *Journal of Psychoeducational Assessment*, 33(5), 451–472. <https://doi.org/10.1177/0734282914553551>
- 10) Boldrini, E., Sappa, V., & Aprea, C. (2019). Which difficulties and resources do vocational teachers perceive? An exploratory study setting the stage for investigating teachers' resilience in Switzerland. *Teachers and Teaching*, 25(1), 125–141. <https://doi.org/10.1080/13540602.2018.1520086>
- 11) Bonoli, L., Berger, J.-L., & Lamamra, N. (Eds.). (2018). *Enjeux de la formation professionnelle en Suisse. Le « modèle » suisse sous la loupe [Challenges for vocational education and training in Switzerland. The Swiss "model" under the microscope]*. Seismo.
- 12) Brown, T. A. (2015). *Confirmatory factor analysis for applied research (2nd ed.)*. The Guilford Press.
- 13) Browne, M. W., & Cudeck, R. (1993). Alternative ways of assessing model fit. In K. A. Bollen, & J. S. Long (Eds.), *Testing structural equation models* (pp. 136–162). Sage.
- 14) Brynjolfsson, E., & McAfee, A. (2014). *The second machine age. Work, progress, and prosperity in a time of brilliant technologies*. W. W. Norton & Company.
- 15) Bührer, C., & Hagist, C. (2017). The effect of digitalization on the labor market. In H. Ellermann, P. Kreutter, & W. Messner (Eds.), *The Palgrave handbook of managing continuous business transformation* (pp. 115–137). Palgrave Macmillan. https://doi.org/10.1057/978-1-137-60228-2_5.
- 16) Caena, F., & Redecker, C. (2019). Aligning teacher competence frameworks to 21st century challenges: The case for the European Digital Competence Framework for Educators (Digcompedu). *European Journal of Education*, 54(3), 356–369. <https://doi.org/10.1111/ejed.12345>
- 17) Calvani, A., Fini, A., & Ranieri, M. (2010). La competenza digitale nella scuola. *Modelli e strumenti per valutarla e svilupparla [Digital Competence in school. Models and tools for assessing and developing it]*. Erickson.
- 18) Carretero, S., Vuorikari, R., & Punie, Y. (2017). *DigComp 2.1: The Digital Competence Framework for Citizens with eight proficiency levels and examples of use*. Publications Office of the European Union. <https://doi.org/10.2760/38842>
- 19) Cattaneo, Alberto A. P., Gurtner, Jean-Luc, & Felder, Joris (2021). Digital tools as boundary objects to support connectivity in dual vocational education: Towards a definition of design principles. In I Zitter, E. Kyndt, & S. Beusaert (Eds.), *At the intersection of (continuous) education and work: Practices and underlying principles* (pp. 137–157). Routledge.
- 20) Conrads, J., Rasmussen, M., Winters, N., Geniet, A., & Langer, L. (2017). Digital education policies in Europe and beyond: Key design principles for more effective policies. In C. Redecker, P. Kamylyis, M. Bacigalupo, & Y. Punie (Eds.), *EUR 29000 EN. Publications Office of the European Union*. <https://doi.org/10.2760/462941>.
- 21) Durndell, A., & Haag, Z. (2002). Computer self efficacy, computer anxiety, attitudes towards the Internet and reported experience with the Internet, by gender, in an East European sample. *Computers in Human Behavior*, 18(5), 521–535. [https://doi.org/10.1016/S0747-5632\(02\)00006-7](https://doi.org/10.1016/S0747-5632(02)00006-7)

Digital Competency Development Among Maritime Vocational Education Lecturers: An Analysis of Personal and Institutional Factors Influencing Teaching Effectiveness in Indonesian Higher Education

- 21) Educational Research Center. (2018). Digital learning framework trial evaluation: Questionnaire for post-primary school principals/digital learning team leaders: End of trial.
- 22) EHB Ausbildung. (2018). Kompetenzprofile Berufsbildungs-Verantwortliche. Lehrpersonen Berufsfachschulen und höhere Fachschulen, Berufsbildende in überbetrieblichen Kursen und Lehrwerkstätten [Competence profiles of VET professionals. Teachers at vocational schools and colleges, VET instructors in inter-company courses and training workshops]. Eidgenössisches Hochschulinstitut für Berufsbildung EHB.
- 23) Eickelmann, B., Gerick, J., & Vennemann, M. (2019). Unerwartet erfolgreiche Schulen im digitalen Zeitalter. Eine Analyse von Schulmerkmalen resilienter Schultypen auf Grundlage der IEA-Studie ICILS 2013 [Unexpectedly successful schools in the digital age. An analysis of school characteristics of resilient school types based on the IEA study ICILS 2013]. *Journal for educational research online*, 11(1), 118–144.
- 24) Ertmer, P. A., Ottenbreit-Leftwich, A. T., Sadik, O., Sendurur, E., & Sendurur, P. (2012). Teacher beliefs and technology integration practices: A critical relationship. *Computers & Education*, 59(2), 423–435. <https://doi.org/10.1016/j.compedu.2012.02.001> European Commission. (2018). Selfie. https://ec.europa.eu/education/schools-go-digital_en.
- 25) Ferrari, A. (2012). Digital competence in practice: An analysis of frameworks. JRC Technical Reports. Luxembourg: European Union. Frey, C. B., & Osborne, M. A. (2013). The future of employment: How susceptible are jobs to computerisation. Oxford University Press.
- 26) Garzon Artacho, E., Martínez, T. S., Ortega Martin, J. L., Marin Marin, J. A., & Gomez Garcia, G. (2020). Teacher training in lifelong learning—the importance of digital competence in the encouragement of teaching innovation. *Sustainability*, 12(7), 2852.
- 27) Ghomi, M., & Redecker, C. (2019). Digital competence of educators (DigCompEdu): Development and evaluation of a self-assessment instrument for teachers' digital competence. *Proceedings of the 11th International Conference on Computer Supported Education (CSDU 2019)*, 1, 541–548.
- 28) Gil-Flores, J., Rodríguez-Santero, J., & Torres-Gordillo, J.-J. (2017). Factors that explain the use of ICT in secondary-education classrooms: The role of teacher characteristics and school infrastructure. *Computers in Human Behavior*, 68, 441–449. <https://doi.org/10.1016/j.chb.2016.11.057>
- 29) Glister, P. (1997). *Digital literacy*. Wiley.
- 30) Grollmann, P. (2008). The quality of vocational teachers: Teacher education, institutional roles and professional reality. *European Educational Research Journal*, 7(4), 535–547. <https://doi.org/10.2304/eerj.2008.7.4.535>
- 31) Guggemos, J., & Seufert, S. (2021). Teaching with and teaching about technology – evidence for professional development of in-service teachers. *Computers in Human Behavior*, 115, 106613. <https://doi.org/10.1016/j.chb.2020.106613>
- 32) Guillén-Gámez, F. D., Mayorga-Fernández, M. J., Bravo-Agapito, J., & Escribano-Ortiz, D. (2020). Analysis of teachers' pedagogical digital competence: Identification of factors predicting their acquisition (pp. 1–18). *Technology, Knowledge and Learning*. <https://doi.org/10.1007/s10758-019-09432-7>
- 33) Hatlevik, O. E. (2017). Examining the relationship between teachers' self-efficacy, their digital competence, strategies to evaluate information, and use of ICT at school. *Scandinavian Journal of Educational Research*, 61(5), 555–567. <https://doi.org/10.1080/00313831.2016.1172501>
- 34) Hinojo-Lucena, F., Aznar-Díaz, I., Cáceres-Reche, M., Trujillo-Torres, J., & Romero-Rodríguez, J. (2019). Factors influencing the development of digital competence in teachers: Analysis of the teaching staff of permanent education centres. *IEEE Access*, 7, 178744–178752. <https://doi.org/10.1109/ACCESS.2019.2957438>
- 35) Hu, L.-T., & Bentler, P. M. (1999). Cutoff criteria for fit indexes in covariance structure analysis: Conventional criteria versus new alternatives. *Structural Equation Modeling*, 6(1), 1–55. <https://doi.org/10.1080/10705519909540118>
- 36) Ilomäki, L., Paavola, S., Lakkala, M., & Kantosalo, A. (2016). Digital competence – an emergent boundary concept for policy and educational research. *Education and Information Technologies*, 21(3), 655–679. <https://doi.org/10.1007/s10639-014-9346-4> Initiative D21. (2016). Berlin: Sonderstudie »Schule Digital«.
- 37) Instefjord, E., & Munthe, E. (2016). Preparing pre-service teachers to integrate technology: An analysis of the emphasis on digital competence in teacher education curricula. *European Journal of Teacher Education*, 39(1), 77–93. <https://doi.org/10.1080/02619768.2015.1100602>

Digital Competency Development Among Maritime Vocational Education Lecturers: An Analysis of Personal and Institutional Factors Influencing Teaching Effectiveness in Indonesian Higher Education

- 38) Joint Research Centre. (2020). DigCompEdu check-in self-reflection tool. European Commission <https://ec.europa.eu/jrc/en/digcompedu/self-assessment>.
- 39) Kamylyis, P., Punie, Y., & Devine, J. (2015). Promoting effective digital-age learning - a European framework for digitally-competent educational organisations. <https://doi.org/10.2791/54070>
- 40) Kilbrink, N., Enochsson, A.-B., & Soöderlind, L. (2020). Digital technology as boundary objects : Teachers' experiences in Swedish vocational education. In C. Aprea, V. Sappa, & R. Tenberg (Eds.), *Konnektivitaät und lernortintegrierte Kompetenzentwicklung in der beruflichen Bildung [Connectivity and integrative competence development in vocational and professional education and training* (pp. 233–251). Franz Steiner Verlag.
- 41) Kirk, R. (1996). Practical significance: A concept whose time has come. *Educational and Psychological Measurement*, 56, 746–759.
- 42) KMK. (2016). Strategie der Kultusministerkonferenz „Bildung in der digitalen Welt“ [Strategy of the Standing Conference of the Ministers of Education and Cultural Affairs "Education in the Digital World". <https://www.kmk.org/themen/bildung-in-der-digitalen-welt/strategie-bildung-in-der-digitalen-welt.html>.
- 43) Knezek, G., & Christensen, R. (2016). Extending the will, skill, tool model of technology integration: Adding pedagogy as a new model construct. *Journal of Computing in Higher Education*, 28(3), 307–325. <https://doi.org/10.1007/s12528-016-9120-2>
- 44) Knezek, G., Christensen, R., Miyashita, K., & Ropp, M. (2000). Instruments for assessing educator progress in technology integration. Institute for the Integration of Technology into Teaching and Learning (IITTL).
- 45) Koehler, M., Mishra, P., Kereluik, K., Shin, T. S., & Graham, C. R. (2014). The technological pedagogical content knowledge framework. In J. M. Spector, M. D. Merrill, J. Elen, & M. J. Bishop (Eds.), *Handbook of research on educational communications and technology* (4th ed., pp. 101–112). Springer. <https://doi.org/10.1007/978-1-4614-3185-5>.
- 46) Kothgassner, O. D., Felnhofer, A., Hauk, N., Kastenhofer, E., Gomm, J., & Kryspin-Exner, I. (2012). TUI. Technology usage inventory.
- 47) Krumsvik, R. J., Jones, L.Ø., Øfstegaard, M., & Eikeland, O. J. (2016). Upper secondary school teachers' digital competence: Analysed by demographic, personal and professional characteristics. *Nordic Journal of Digital Literacy*, 11(3), 143–164.
- 48) Le Boterf, G. (2000). *Compétence et navigation professionnelle [Competence and professional navigation]*. Les Éditions d'organisation.
- 49) Lucas, M., Bem-Haja, P., Siddiq, F., Moreira, A., & Redecker, C. (2021). The relation between in-service teachers' digital competence and personal and contextual factors: What matters most? *Computers & Education*, 160, 104052. <https://doi.org/10.1016/j.compedu.2020.104052>
- 50) McGarr, O., & McDonagh, A. (2019). Digital competence in teacher education, output 1 of the Erasmus funded developing student teachers' digital competence (DICTE) project. <https://dicte.oslomet.no/wp-content/uploads/2019/03/DICTE-Digital-Competence-in-Teacher-Ed.-literature-review.pdf>.
- 51) MENTEP (Mentoring Technology-Enhanced Pedagogy). (2017). Self assessment tool: TET-SAT. <http://mentep.eun.org/tet-sat>.
- 52) MENTEP (Mentoring Technology-Enhanced Pedagogy). (2018). Online self-assessment. http://mentep.eun.org/documents/2390578/2452293/Brochure_Mentep_2017.pdf/32784bfc-ca0d-49ab-af55-929abd15ab79.
- 53) Mishra, P., & Koehler, M. J. (2006). Technological pedagogical content knowledge: A framework for teacher knowledge. *Teachers College Record*, 108(6), 1017–1054. Misra, P. K. (2011). VET teachers in europe: Policies, practices and challenges. *Journal of Vocational Education and Training*, 63(1), 27–45. <https://doi.org/10.1080/13636820.2011.552732>
- 54) Muth'en, M., & Muth'en, B. O. (2015). *Mplus user's guide* (7th ed.). Muth'en & Muth'en.
- 55) Nardi, B. A. (Ed.). (1996). *Context and consciousness: Activity theory and human-computer interaction*. MIT Press. Nunnally, J. C. (1978). *Psychometric theory* (2nd ed.). McGraw-Hill. OECD. (2009). *Learning for jobs. OECD reviews of vocational education and training. Switzerland: Organisation for Economic and Co-operation and Development*. OECD. (2019). *OECD skills outlook 2019. Organisation for Economic and Co-operation and Development*. <https://doi.org/10.1787/df80bc12-en>

Digital Competency Development Among Maritime Vocational Education Lecturers: An Analysis of Personal and Institutional Factors Influencing Teaching Effectiveness in Indonesian Higher Education

- 56) Oomen, I., & Leenes, R. (2008). Privacy risk perceptions and privacy protection strategies. In E. de Leeuw, S. Fischer-Hübner, J. Tseng, & J. Borking (Eds.), *Policies and research in identity management* (Vol. 261, pp. 121–138). Springer. https://doi.org/10.1007/978-0-387-77996-6_10.
- 57) Ottestad, G., & Gudmundsdottir, G. B. (2018). Information and communication technology policy in primary and secondary education in Europe. In J. Voogt,
- 58) G. Knezek, R. Christensen, & K. W. Lai (Eds.), *Second handbook of information technology in primary and secondary education*(1343-1362). Springer.
- 59) P´erez-Escoda, A., Garc´ıa-Ruiz, R., & Aguaded, I. (2019). Dimensions of digital literacy based on five models of development/*Dimensiones de la alfabetizaci3n digital a partir de cinco modelos de desarrollo*. *Culture and Education*, 31(2), 232–266. <https://doi.org/10.1080/11356405.2019.1603274>
- 60) Pettersson, F. (2018). On the issues of digital competence in educational contexts – a review of literature. *Education and Information Technologies*, 23(3), 1005–1021. <https://doi.org/10.1007/s10639-017-9649-3>
- 61) Pfeiffer, S. (2018). The ‘Future of Employment’ on the shop floor: Why production jobs are less susceptible to computerization than assumed. *International Journal for Research in Vocational Education and Training*, 5(3), 208–225. <https://doi.org/10.13152/IJRVET.5.3.4>
- 62) Redecker, C., & Punie, Y. (2017). *European framework for the digital competence of educators: DigCompEdu*. Luxembourg: Publications Office of the European Union. <https://doi.org/10.2760/159770>
- 63) Roll, M. J. J., & Ifenthaler, D. (2021). Multidisciplinary digital competencies of pre-service vocational teachers. *Empirical Research in Vocational Education and Training*, 13(1), 7. <https://doi.org/10.1186/s40461-021-00112-4>
- 64) Rosenberg, J. M., & Koehler, M. J. (2015). Context and technological pedagogical content knowledge (TPACK): A systematic review. *Journal of Research on Technology in Education*, 47(3), 186–210. <https://doi.org/10.1080/15391523.2015.1052663>
- 65) S´anchez Prieto, J., Trujillo Torres, J. M., Go´mez Garc´ıa, M., & Go´mez Garc´ıa, G. (2020). Gender and digital teaching competence in dual vocational education and training. *Education Sciences*, 10(3). <https://doi.org/10.3390/educsci10030084>
- 66) Sappa, V., & Aprea, C. (2018). L’apprentissage professionnel entre l’´ecole et l’entreprise: D’efis, mod`eles et conceptions individuelles [professional learning between school and company: Challenges, models and individual conceptions]. In J.-L. Berger, N. Lamamra, & L. Bonoli (Eds.), *Enjeux de la formation professionnelle suisse. Le ‘mod`ele’ suisse sous la loupe* [Challenges for Swiss vocational education and training. The Swiss ‘model’ under the microscope] (pp. 267–293). Seismo.
- 67) Schwendimann, B., Cattaneo, A., Dehler Zufferey, J., B’etrancourt, M., Gurtner, J.-L., & Dillenbourg, P. (2015). The ‘Erfahrraum’: A model for exploiting educational technologies in dual vocational systems. *Journal of Vocational Education and Training*, 67(3), 367–396. <https://doi.org/10.1080/13636820.2015.1061041>
- 68) Seufert, S., & Scheffler, N. (2018). Developing digital competences of vocational teachers. In , *Digital multimedia: Concepts, methodologies, tools, and applications*Information resources management association (pp. 199–216). <https://doi.org/10.4018/978-1-5225-3822-6.ch010>. IGI Global.
- 69) Shulman, L. S. (1986). Those who understand: Knowledge growth in teaching. *Educational Researcher*, 15(2), 4–14. <https://doi.org/10.3102/0013189X015002004>
- Siddiq, F., & Scherer, R. (2019). Is there a gender gap? A meta-analysis of the gender differences in students’ ICT literacy. *Educational Research Review*, 27, 205–217. <https://doi.org/10.1016/j.edurev.2019.03.007>
- 70) Swiss Confederation. (2015). *Rahmenlehrpla`ne berufsbildungsverantwortliche* [teaching framework programmes. Persons responsible for vocational training]. State Secretariat for education, research and innovation. [https://www.sbf.admin.ch/dam/sbf/de/dokumente/rahmenlehrplaeneberufsbildungs-verantwortliche.pdf](https://www.sbf.admin.ch/dam/sbf/de/dokumente/rahmenlehrplaeneberufsbildungs-verantwortliche.pdf.download.pdf/rahmenlehrplaeneberufsbildungs-verantwortliche.pdf).
- 71) Swiss Confederation. (2017a). *Rapport sur les principales conditions-cadre pour l’´conomie num´erique* [Report on the main framework conditions for the digital economy]. Bern: Swiss confederation. Federal Council.
- 72) Swiss Confederation. (2017b). *D’efis de la num´erisation pour la formation et la recherche en Suisse* [Challenges of digitisation for education and research in Switzerland]. Bern: Swiss confederation. Federal Council.
- 73) Swiss Confederation. (2018). *Digital Switzerland Strategy*.

Digital Competency Development Among Maritime Vocational Education Lecturers: An Analysis of Personal and Institutional Factors Influencing Teaching Effectiveness in Indonesian Higher Education

https://www.bakom.admin.ch/dam/bakom/en/dokumente/informationsgesellschaft/strategie/Strategie_DS_Digital_2-EN-barrierenfrei.pdf.download.pdf/Strategie_DS_Digital_2-EN-barrierenfrei.pdf.

- 74) Swiss Confederation. (2019). Orientierungsrahmen Grundkompetenzen in Informations- und Kommunikationstechnologien (IKT) [Orientation framework for basic competences in information and communication technologies (ICT)]. State Secretariat for Education, Research and Innovation
https://www.sbfi.admin.ch/dam/sbfi/de/dokumente/2019/02/orientierungsrahmen-ikt.pdf.download.pdf/20190205_Orientierungsrahmen_IKT_GK_DE.pdf.
- 75) Taylor, A., & Freeman, S. (2011). 'Made in the trade': Youth attitudes toward apprenticeship certification. *Journal of Vocational Education and Training*, 63(3), 345–362. <https://doi.org/10.1080/13636820.2011.570455>
- 76) Tondeur, J., Aesaert, K., Prestridge, S., & Consuegra, E. (2018). A multilevel analysis of what matters in the training of pre-service teacher's ICT competencies. *Computers & Education*, 122, 32–42.
<https://doi.org/10.1016/j.compedu.2018.03.002>
- UNESCO. (2018). *Unesco ICT competency framework for teachers. Version 3*. UNESCO.
- 77) Vocational, Professional Education, & Training Act VPETA. (2002). <https://www.fedlex.admin.ch/eli/cc/2003/674/en>. Vocational, Professional Education, & Training Ordinance VPETO. (2002).
<https://www.fedlex.admin.ch/eli/cc/2003/748/en>.
- 78) Wendt, H., Bos, W., Tarelli, I., Vaskova, A., & Walzebug, A. (Eds.). (2016). *IGLU & TIMSS 2011. Skalenhandbuch zur Dokumentation der Erhebungsinstrumente und Arbeit mit den Datensätzen [Manual for documenting the survey instruments and working with the data set]*. Waxmann.
- 79) Zarifian, P. (2001). *Le modèle de la compétence [The competence model]*. Éditions Liaisons

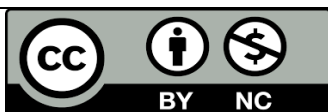

There is an Open Access article, distributed under the term of the Creative Commons Attribution – Non Commercial 4.0 International (CC BY-NC 4.0) (<https://creativecommons.org/licenses/by-nc/4.0/>), which permits remixing, adapting and building upon the work for non-commercial use, provided the original work is properly cited.

Understanding Digital Technology Integration in Merchant Marine College: Examining Teacher Digital Competency through TAM Framework



F. Pambudi Widiatmaka¹, Pranyoto², Didik Dwi Suharso³, Kundori⁴, Riasny dewi Annafril⁵, Sukrisno⁶

^{1,2,3,5}Merchant Marine Polytechnic, Singosari Raya No.2A, Kota Semarang, 50242, Indonesia.

⁴Universitas Maritim AMNI, Sukarno Hatta street No. 180, Pedurungan, Kota Semarang, 50199, Indonesia

⁶Indonesian College of Tourism Economics, Lamongan Tengah bendan, Kota Semarang, 50233, Indonesia

ABSTRACT: This study examines the relationship between teacher digital competency and technology adoption in maritime vocational education institutions. The research aims to investigate how digital competency influences perceived usefulness, perceived ease of use, behavioral intention, and actual technology use among maritime educators. Using the Technology Acceptance Model (TAM) framework, the study explores the interconnected relationships between these variables in a specialized educational context. Data collection involved an online survey of lecturers and instructors from maritime vocational colleges under the Ministry of Transportation. The study employed structural equation modeling (SEM) using AMOS software for analysis, providing a comprehensive examination of the relationships between variables. Results reveal significant positive relationships between teacher digital competency and technology adoption factors. The findings demonstrate that digital competency strongly influences both perceived usefulness and ease of use of technology, which in turn affects behavioral intention and actual technology implementation. The research contributes to understanding technology adoption in maritime vocational education and provides practical implications for institutions developing digital competency programs. The study suggests that successful technology integration depends on both technical competency development and positive perceptions of technology's utility, supported by adequate institutional infrastructure.

KEYWORDS: Digital Competency, Technology Acceptance Model, Maritime Education, Vocational Training, Educational Technology

I. INTRODUCTION

The rapid advancement of digital technology over the past two decades has fundamentally transformed the educational landscape, particularly in higher education. This transformation has brought both opportunities and challenges, especially in specialized fields like maritime education where digital competencies are becoming increasingly crucial. The widespread availability of digital tools and learning materials has created unprecedented possibilities for enhancing teaching and learning processes, yet the implementation of these technologies remains inconsistent among educators (Fraillon et al., 2019). The significance of digital competency in higher education has become more pronounced, particularly as governments worldwide initiate training programs and reforms to promote technological integration in education. However, despite substantial investments in hardware and software infrastructure, a concerning gap persists between the availability of digital resources and their effective implementation in teaching practices. This disparity is particularly evident in the statistics showing that less than 50% of educators effectively utilize technology in their teaching methods (Fraillon et al., 2019).

The COVID-19 pandemic has further highlighted the critical importance of digital competency among educators, revealing substantial variations in their readiness to integrate technology into their pedagogical approaches. This situation has become

Understanding Digital Technology Integration in Merchant Marine College: Examining Teacher Digital Competency Through TAM Framework

particularly pressing in specialized educational institutions, such as maritime education, where the integration of digital technology is not just an enhancement but a necessity for preparing students for an increasingly digitalized maritime industry. The OECD's 2018 International Survey on Teaching and Learning revealed a concerning statistic: only 43% of educators reported feeling adequately prepared to incorporate technology into their teaching methodologies (OECD, 2019).

A significant research gap exists in understanding the specific factors influencing digital competency adoption among educators, particularly in specialized higher education contexts like maritime institutions. While existing studies have explored various aspects of technology integration in general education settings, there is limited research focusing on the unique challenges and requirements of maritime education institutions, where digital competency intersects with specialized maritime knowledge and skills.

The complexity of this issue is further highlighted by the interplay between institutional support and individual educator characteristics. While institutional support is crucial, research indicates that it alone does not guarantee successful technology integration. Studies have shown that individual characteristics of educators, including their beliefs, attitudes, motivation, and perceived self-efficacy, play a more significant role in explaining technology usage compared to infrastructure accessibility (Backfisch et al., 2020; Gil-Flores et al., 2017; Tondeur et al., 2008; Valtonen et al., 2015).

The Technology Acceptance Model (TAM) provides a theoretical framework for understanding educators' technology adoption, emphasizing the importance of perceived ease of use and usefulness. However, recent meta-analyses have revealed inconsistencies in previous TAM studies, with explained variance in technology adoption ranging from 3% to 90% across different research contexts (Scherer & Teo, 2019). This variability suggests the need for a more nuanced understanding of technology acceptance in specialized educational contexts.

In maritime education institutions, the challenge of digital competency development is particularly complex due to the need to bridge theoretical knowledge with practical skills. Digital technologies serve as crucial tools for connecting classroom teaching with real-world experiences, requiring educators to possess both general digital competencies and specialized technical knowledge (Cattaneo et al., 2022). This dual requirement creates unique challenges in implementing effective digital integration strategies.

This study addresses these challenges by focusing specifically on maritime education institutions, examining the factors influencing digital competency among faculty members. Understanding these factors is crucial for developing targeted interventions and support systems that can effectively enhance educators' digital capabilities. The research aims to uncover the specific elements affecting digital competency adoption among maritime educators, considering both institutional and individual factors that influence technology integration in maritime education settings (Krumsvik et al., 2016; Sailer et al., 2021; Scherer et al., 2021).

The findings of this study will be particularly valuable for maritime education institutions seeking to enhance their faculty's digital competencies. By identifying the key factors influencing digital competency adoption, this research will provide crucial insights for developing more effective professional development programs and support systems. Additionally, understanding these factors will help address the specific challenges faced by maritime educators in integrating digital technologies into their teaching practices.

This research specifically examines the case of merchant marine education institutions, investigating how they can enhance their faculty's digital competencies and identifying the key factors influencing this process. The study aims to answer critical questions about the specific challenges and opportunities in developing digital competencies among maritime educators, providing practical insights for institutional policy development and professional development programs in maritime education settings (Schwendimann et al., 2015; Kyndt et al., 2022; Caena & Redecker, 2019; Redecker, 2017).

II. LITERATURE REVIEW AND HYPOTHESIS DEVELOPMENT

Theory reasoned action and technological acceptance model

The Theory of Reasoned Action (TRA) provides a foundational framework for understanding determinants of intended behavior in technology adoption contexts. TRA posits that an individual's performance of a specific behavior is determined by behavioral intention, which in turn is influenced by attitudes and subjective norms towards that behavior. Behavioral intention represents a measure of one's planned actions, while attitude reflects the positive or negative emotions towards performing an action. Subjective norms capture an individual's perception of whether important others believe they should perform the action (Ajzen and Fishbein, 1980; Fishbein and Ajzen, 1975). According to TRA, attitudes toward behavior are shaped by significant beliefs about outcomes multiplied by evaluations of those outcomes (Davis et al., 1989). Over the years, TRA has proven

Understanding Digital Technology Integration in Merchant Marine College: Examining Teacher Digital Competency Through TAM Framework

invaluable in studying human behavior related to information and communication technology adoption, with attitudes and subjective norms emerging as critical determinants of technology usage intentions (Yuen and Ma, 2008).

Building on TRA, the Technology Acceptance Model (TAM) was developed to specifically explain factors influencing end-user technology acceptance. TAM incorporates two core belief constructs - perceived usefulness and perceived ease of use - as critical determinants of user intention to adopt technology. Perceived usefulness refers to the degree to which someone believes using a particular system will enhance their job performance, while perceived ease of use indicates the belief that using a system will be relatively effortless (Davis, 1989). Studies have shown that incorporating perceived usefulness as an external variable into TAM provides more significant variance explanation and greater impact on TAM elements (Holden and Rada, 2011). While widely applied across various educational contexts including school teachers (Pynoo et al., 2011), virtual learning environments (Rienties et al., 2016), and pre-service teachers (Teo, 2010), TAM has faced criticism for being oversimplified (Bagozzi, 2007) and lacking external validity (Dishaw and Strong, 1999).

Teacher digital competency, perceive ease of use and perceive of usefulness

Teacher Digital Competency (TDC) frameworks offer important theoretical foundations through both conceptual and practice-oriented approaches. The Technological Pedagogical Content Knowledge (TPACK) model represents a key conceptual framework comprising seven components spanning disciplinary content, pedagogy, and teaching methodology (Koehler et al., 2014; Mishra & Koehler, 2006). The Pedagogy Will Skill Tool model further outlines critical factors driving technology integration, including beliefs, competency, confidence, and infrastructure access (Knezek & Christensen, 2016). Practice-oriented frameworks from UNESCO and European initiatives provide systematic approaches for evaluating digital competencies (Caena & Redecker, 2019; Ghomi & Redecker, 2019).

Teacher Digital Competency (TDC) must account for specific educational contexts, particularly in dual Vocational Education and Training (VET) settings where learning occurs across multiple locations, alternating between school-based and work-based pathways. Research by Sappa and Aprea (2018) and Taylor and Freeman (2011) highlights these distinct teaching profiles and proposes specific technology integration models suited to these environments. Schwendimann et al. (2015) further emphasize the importance of adapting technological approaches to bridge the school-work divide.

Available instruments must be tailored to the VET context to effectively understand digital competencies within this domain, as existing tools have limitations, as noted by Lucas et al. (2021). While DigCompEdu's six sections contain extensive content covering various related skills requiring detailed individual examination, surveys consisting of 22 items (Caena & Redecker, 2019; Ghomi & Redecker, 2019) evaluate each competency using single items, without considering the complexity of individual skills. Based on this understanding, two initial hypotheses emerge:

H1: Teacher digital competency positively influences perceived ease of use

H2: Teacher digital competency positively influences perceived usefulness

Perceive ease of use ,perceive of usefulness , behavioural intention and actual to use

The Technology Acceptance Model (TAM) serves as a comprehensive framework designed to illuminate the complex dynamics underlying technology adoption, behavioral prediction, and successful implementation rationales. This model provides crucial insights into how users interact with and ultimately accept new technological systems in various contexts (Davis, 1989, 1993).

At its core, TAM examines the intricate relationships between external system factors and their practical application, offering a structured approach to understanding user acceptance patterns. The model's development involved extensive research into human behavior and information systems management, leading to the creation of sophisticated measurement scales for two key constructs: perceived ease of use and perceived usefulness. These elements emerged as essential factors in determining how users approach and accept new technologies (Johnson & Payne, 1985; Payne, 1982; Robey, 1979).

The model's theoretical foundation rests on the premise that individuals make technology adoption decisions through a careful evaluation process, weighing potential advantages against perceived implementation challenges. This cost-benefit analysis significantly influences how users approach new information systems, suggesting that adoption decisions stem from a balanced assessment of anticipated benefits versus expected difficulties in implementation and use (Davis, 1989).

Perceived usefulness, a central component of TAM, encompasses users' beliefs about how specific technologies can enhance their performance and effectiveness. This concept builds upon established psychological principles regarding outcome expectations and their role in motivating behavior. Research demonstrates that users' expectations about system performance play a crucial role in determining actual system utilization patterns (Bandura, 1982; Robey, 1979).

Understanding Digital Technology Integration in Merchant Marine College: Examining Teacher Digital Competency Through TAM Framework

The model's other key component, perceived ease of use, focuses on users' assessments of how effortlessly they can incorporate new technologies into their existing workflows. This aspect draws heavily from self-efficacy theory, emphasizing the importance of users' confidence in their ability to successfully engage with new systems. The construct highlights how individual beliefs about task capability directly influence technology adoption decisions (Davis, 1989; Bandura, 1982; Hill, Smith & Mann, 1987).

Through these interconnected elements, TAM provides a robust framework for understanding and predicting technology acceptance behaviors. The model suggests that successful technology implementation depends not only on the system's inherent capabilities but also on users' perceptions of its utility and accessibility. This comprehensive approach helps explain why similar technologies may experience different adoption rates across various contexts and user groups. Based on this understanding, two initial hypotheses emerge:

H3: Perceived ease of use positively influences perceived usefulness

H4: Perceived usefulness positively influences behavioral intention

H5: Perceived ease of use positively influences behavioral intention

H6: Behavioral intention positively influences actual use

III. METHOD

This study employs a quantitative approach using primary data collected through field surveys, with questionnaires serving as the primary data collection instrument administered directly to respondents (Bam, 1992). Data collection was conducted through an online survey, voluntarily completed by lecturers and instructors from vocational colleges under the Ministry of Transportation between January and June 2024. After receiving educational administration approval, survey links were distributed to all vocational institutions, requesting management to forward them to faculty members and instructors. Participants were informed about research objectives and assured of confidentiality. The measurement instruments employ TAM variables comprising six items, originally developed by Venkatesh et al. (2003), to assess perceived usefulness (PU) and perceived ease of use (PEU) among sampled faculty members. Response options range from strongly disagree (1) to strongly agree (6). Teachers' Digital Competence Beliefs were evaluated using a 22-item scale (Lucas et al., 2021) categorized into six dimensions based on the European Framework for Digital Competence of Educators (Redecker, 2017).

For structural equation modeling (SEM) analysis, following Hair et al. (2010), a minimum sample size of 100 is required for models with five or fewer constructs. Using Soper's sample size calculator with five latent variables, 16 observed variables, and a 0.05 probability level indicated a minimum sample size of 173 (Soper, 2006). Our sample size of 388 significantly exceeds these requirements, ensuring adequate statistical power.

The study employs SEM using AMOS 24.0 software with maximum likelihood estimation, following a seven-step modeling process as outlined by Augusty (2006). This includes confirmatory factor analysis and regression weight analysis to test hypotheses H1 through H6. The model's goodness-of-fit is evaluated using multiple indices including Chi-square statistics, GFI, AGFI, CFI, TLI, CMIN/DF, and RMSEA, with established cutoff values following Brown (1993) and Arbuckle (1997).

IV. RESULTS AND DISCUSSION

Confirmatory factor analysis is employed to assess validity and provide a concise overview of indicators. To address data distribution exceeding normalization criteria, denormalized data processing follows Tabachnick et al.'s (2013) formula, applying negative root transformation $X_n = 1/(k-X)$. Following Arbuckle (2016) and Tabachnick et al. (2013), the Average Variance Extracted (AVE) evaluates item quality in construct conclusions, with values exceeding the 0.5 threshold and higher standardized factor loadings (Bagozzi & Yi, 1988). Reliability criteria from Arbuckle (2016) require values above 0.7. Results demonstrate all research variables exceed this threshold, as shown in

Table 1. Measurement of validity and reliability of the construct

Digital Competency Items	Factor Loading	t-values	Cronbach's Alpha	Composite Reliability
Teacher Digital Competency (Venkatesh et al., 2003)			0.781	0.804
TDC 1	0.783	5.908		
TDC 2	0.802	3.091		
TDC 3	0.793	6.002		

Understanding Digital Technology Integration in Merchant Marine College: Examining Teacher Digital Competency Through TAM Framework

TDC 4	0.812	4.894		
Perceived Ease of Use (Redecker, 2017), (Lucas et al., 2021)			0.813	0.808
PEOU 1	0.802	6.302		
PEOU 2	0.811	5.981		
PEOU 3	0.794	5.043		
PEOU 4	0.826	5.926		
Perceived Usefulness (Redecker, 2017), (Lucas et al., 2021)			0.824	0.863
POU 1	0.791	4.281		
POU 2	0.808	5.309		
POU 3	0.781	7.418		
POU 4	0.819	6.083		
Behavioral Intention (Redecker, 2017), (Lucas et al., 2021)			0.795	0.809
BI 1	0.903	5.924		
BI 2	0.881	5.773		
BI 3	0.867	6.093		
BI 4	0.792	6.128		
Actual Use (Redecker, 2017), (Lucas et al., 2021)			0.786	0.814
AOU 1	0.813	5.813		
AOU 2	0.881	5.996		
AOU 3	0.906	6.417		
AOU 4	0.808	5.809		

The statistical analysis using Amos software was employed to test the proposed research model and hypotheses. The selection of Structural Equation Modeling (SEM) as the scientific technique was based on several key factors. First, it allows for equation-based work where variables can be regressed and predicted across multiple equations, aligning with the proposed research model, as noted by Nachtigall and colleagues. Additionally, SEM provides a comprehensive systematic analysis of interrelated questions and enables modeling relationships between multiple independent and dependent theoretical constructs simultaneously, as highlighted by Tarka in his research. Furthermore, SEM demonstrates excellence in its ability to test mediation processes concurrently, according to Tabachnick and associates. The testing process encompasses three main phases, beginning with a test of fit to evaluate the proposed model's suitability, followed by model evaluation to assess the research model's acceptability, and concluding with a thorough statistical analysis of the proposed model and hypotheses. This structured methodological approach ensures comprehensive validation of the research model and its associated hypotheses.

Table 2. Goodness of Fit Testing

The Goodness of Fit Test	Cut off Value	Result	Conclusion
Chi-square at a significance level 5%	208,904	0,00	Nonfit
P	≤ 0,05	0,00	Fit
GFI	≥ 0,90	0,956	Fit
NFI	≥ 0,90	0,942	Fit
TLI	≥ 0,90	0,961	Fit
CFI	≥ 0,90	0,959	Fit
RMSEA	0,05 ≤ RMSEA ≤ 0,08	0,03	Fit

The measurement results of the TLI, CFI, and RMSEA indices fell within the expected value ranges, although the GFI and AGFI values were marginally accepted due to data variation. Based on these findings, we can conclude that the SEM model's fitness

Understanding Digital Technology Integration in Merchant Marine College: Examining Teacher Digital Competency Through TAM Framework

test results have met the acceptance requirements. This indicates that the constructs used to form the research model have fulfilled the model's fitness criteria. The analysis yielded specific statistical values: a Chi Square of 208.904 with a significance of 0.00, GFI of 0.956, NFI of 0.942, CFI of 0.959, TLI of 0.961, and an RMSEA of 0.03. According to Arbuckle and Tabachnick et al. (2013), this evaluation procedure has resulted in mode acceptance and supports further analysis for testing our proposed hypotheses. The comprehensive evaluation process confirms the model's validity and provides a solid foundation for subsequent hypothesis testing as suggested by the aforementioned researchers.

Table 3. Testing hypothesis 1

Hypothesis	Estimate	Std error	Critical ratio	ρ	Conclusion
Teacher Digital Competency → Perceived Usefulness	0.601	0.586	5.781	0.00	Accepted
Teacher Digital Competency → Perceived Ease of Use	0.592	0.517	4.963	0.00	Accepted
Perceived Ease of Use → Perceived Usefulness	0.514	0.408	5.883	0.00	Accepted
Perceived Usefulness → Behavioral Intention	0.608	0.492	8.001	0.00	Accepted
Perceived Ease of Use → Behavioral Intention	0.702	0.491	7.086	0.00	Accepted
Behavioral Intention → Behavioral Intention	0.681	0.588	8.024	0.00	Accepted

H1: Teacher Digital Competency and Perceived Usefulness

Statistical finding: ($t = 5.781 > 2.0$, significance $0.000 < 0.05$). The significant relationship between teacher digital competency and perceived usefulness confirms Lucas et al.'s (2021) findings about technology integration in teaching. This aligns with Tondeur et al.'s (2018) research emphasizing digital competency's importance in maritime vocational education. Teachers with strong digital competencies better recognize technology's benefits for enhancing student learning experiences and preparing them for maritime industry demands. As Sappa and Aprea (2018) noted, this competency enables teachers to effectively utilize online resources and engage in professional development, ultimately improving their teaching effectiveness and student outcomes.

H2: Teacher Digital Competency and Perceived Ease of Use

Statistical finding: ($t = 4.963 > 2.0$, significance $0.0 < 0.05$). The results support findings by Caena & Redecker (2019) regarding the relationship between digital competency and perceived ease of use. Teachers with strong digital foundations demonstrate greater confidence in navigating and implementing technological tools. This confirms Lucas et al.'s (2021) research showing that competent teachers more readily integrate digital resources into their teaching practices. The relationship particularly benefits maritime vocational education, where complex technical systems require confident handling. The findings suggest that investing in teachers' digital competency development directly influences their perception of technology's accessibility and usability in educational settings.

H3: Perceived Ease of Use → Perceived Usefulness

Statistical finding: ($t = 5.883 > 2.0$, significance $0.000 < 0.05$). The significant relationship supports Davis's (1989, 1993) fundamental technology acceptance model principles. As Hwang (2005) and Gefen et al. (2003) found, when teachers find technology easy to use, they're more likely to recognize its benefits. This correlation proves particularly relevant in maritime vocational education, where complex technical systems require both ease of use and clear utility. The findings suggest that user-friendly technological interfaces and systems contribute significantly to teachers' recognition of technology's value in their teaching practices, supporting Araújo & Casais's (2020) conclusions about technology adoption in education.

H4: Perceived Usefulness and Behavioral Intention

Statistical finding: ($t = 8.001 > 2.0$, significance $0.000 < 0.05$). The strong relationship confirms Abdullah and Ward's (2016) findings on technology adoption intentions. Teachers who recognize technology's benefits show greater willingness to integrate it into their teaching practices. This supports Sánchez-Prieto et al.'s (2017) research on technology acceptance in education. The maritime vocational context particularly benefits from this relationship, as teachers who perceive technology's usefulness are more likely to implement industry-relevant digital tools. The findings suggest that emphasizing practical benefits and concrete applications of technology in teaching can significantly influence teachers' intentions to adopt digital tools.

H5: Perceived Ease of Use and Behavioral Intention

Understanding Digital Technology Integration in Merchant Marine College: Examining Teacher Digital Competency Through TAM Framework

Statistical finding: ($t = 7.086 > 2.0$, significance $0.000 < 0.05$). The findings validate Backfisch et al.'s (2021) research on technology adoption in education. When teachers perceive digital tools as accessible and straightforward, their intention to use these tools increases significantly. This supports Scherer et al.'s (2019) observations about individual differences in technology adoption. In maritime vocational education, this relationship proves crucial as complex technical systems require confident user engagement. The results suggest that providing user-friendly interfaces and adequate support systems can significantly boost teachers' intentions to integrate technology into their teaching practices.

H6: Behavioral Intention and Actual Use

Statistical finding: ($t = 8.024 > 2.0$, significance $0 < 0.05$). The strong relationship confirms Davis's (1989, 1993) technology acceptance model's final link. Supporting Sánchez-Prieto et al.'s (2017) findings, strong behavioral intentions translate into actual technology implementation. Baturay et al.'s (2017) emphasis on institutional support's role in this relationship proves particularly relevant in maritime vocational education. The findings suggest that teachers' positive intentions directly influence their actual technology use, especially when supported by proper infrastructure and resources. This relationship highlights the importance of nurturing positive intentions through supportive institutional environments and proper technical infrastructure.

IV. CONCLUSIONS

This study reveals significant relationships between teachers' digital competency and technology adoption in maritime vocational education. The findings demonstrate that digital competency positively influences both perceived usefulness and ease of use of digital technology. These perceptions, in turn, strengthen behavioral intentions to adopt technology in teaching practices. Teachers with strong digital competencies show greater readiness to integrate technology effectively, aligning their teaching methods with current and future labor market demands. The study confirms that perceived ease of use, usefulness, and behavioral intentions lead to actual technology implementation, particularly when supported by adequate institutional infrastructure and resources. These relationships are crucial for successful digital integration in vocational education. The research findings present significant theoretical and practical implications regarding digital technology adoption in vocational higher education.

Theoretical implications demonstrate that teachers' digital competency strongly influences both perceived usefulness and ease of use of digital technology. This supports the Technology Acceptance Model (TAM) framework while introducing new insights by integrating digital competency concepts into technology adoption theories within educational contexts. The findings validate TAM's core assumptions about the relationships between perceived ease of use, perceived usefulness, behavioral intention, and actual technology use.

Practical implications suggest several key recommendations for educational institutions. Institutions should invest in continuous professional development programs to enhance teachers' digital competencies through targeted training in educational software, technology-based teaching methods, and digital curriculum integration. Reliable technological infrastructure and technical support are essential to improve perceived ease of use among teachers.

Developing user-friendly digital learning interfaces and content is crucial for increasing technology adoption. Institutions should promote the benefits of digital technology in enhancing teaching quality and student outcomes through effective communication campaigns. Professional learning communities enable teachers to share best practices and experiences in digital technology integration. Continuous monitoring and evaluation are necessary to ensure behavioral intentions translate into actual technology use.

The study acknowledges several limitations, including sample size constraints, potential geographical bias, and the cross-sectional nature of the research design. Additional factors such as individual characteristics, school culture, and educational policies may influence technology adoption but were not examined. These limitations suggest opportunities for future research to explore technology adoption in vocational education more comprehensively through varied methodological approaches and broader contextual considerations.

REFERENCES

- 1) Abdullah, F., & Ward, R. (2016). Developing a general extended technology acceptance model for E-learning (GETAMEL) by analysing commonly used external factors. *Computers in Human Behavior*, 56, 238–256. <https://doi.org/10.1016/j.chb.2015.11.036>
- 2) Abramson, J., Dawson, M. and Stevens, J. (2015), "An examination of the prior use of e-learning within an extended technology acceptance model and the factors that influence the behavioral intention of users to use m-learning", *SAGE Open*, Vol. 5 No. 4, pp. 1-9.

Understanding Digital Technology Integration in Merchant Marine College: Examining Teacher Digital Competency Through TAM Framework

- 3) Ajzen, I. (1991). The theory of planned behavior. *Organizational Behavior and Human Decision Processes*, 50(2), 179–211. [https://doi.org/10.1016/0749-5978\(91\)90020-T](https://doi.org/10.1016/0749-5978(91)90020-T)
- 4) Ajzen, I., & Fishbein, M. (1975). A Bayesian analysis of attribution processes.
- 5) Ajzen, I. and Fishbein, M. (1980), *Understanding Attitudes and Predicting Social Behaviour*, Prentice-Hall, Englewood Cliffs, NJ.
- 6) *Psychological Bulletin*, 82(2), 261. <https://doi.org/10.1037/h0076477> Backfisch, I., Scherer, R., Siddiq, F., Lachner, A., & Scheiter, K. (2021). Teachers' technology use for teaching: Comparing two explanatory mechanisms. *Teaching and Teacher Education*, 104, 103390. <https://doi.org/10.1016/j.tate.2021.103390>
- 7) Bagozzi, R. P. (2007). The legacy of the technology acceptance model and a proposal for a paradigm shift. *Journal of the Association for Information Systems*, 8(4), 3.
- 8) Bandura, A. (1977). Self-efficacy: Toward a unifying theory of behavioral change.
- 9) *Psychological Review*, 84(2), 191. <https://doi.org/10.1037/0033-295X.84.2.191> Bandura, A. (1986). The explanatory and predictive scope of self-efficacy theory. *Journal of Clinical and Social Psychology*, 4, 359–373. <https://doi.org/10.1521/jscp.1986.4.3.359>
- 10) Bagozzi (2007), "The legacy of technology acceptance model and a proposal for paradigm shift",
- 11) *Journal of the Association for Information Systems*, Vol. 8 No. 4, pp. 244-254.
- 12) Baturay, M. H., Go'kçeerslan, S. ., & Ke, F. (2017). The relationship among pre-service teachers' computer competence, attitude towards computer-assisted education, and intention of technology acceptance. *International Journal of Technology Enhanced Learning*, 9(1), 1–13. <https://doi.org/10.1504/IJTEL.2017.084084>
- 13) Benbasat, I., & Barki, H. (2007). Quo vadis TAM? *Journal of the Association for Information Systems*, 8(4), 7.
- 14) Bingimlas, K. A. (2009). Barriers to the successful integration of ICT in teaching and learning environments: A review of the literature. *Eurasia Journal of Mathematics, Science and Technology Education*, 5(3), 235–245. <https://doi.org/10.12973/ejmste/75275>
- 15) Black, R. A., Yang, Y., Beitra, D., & McCaffrey, S. (2015). Comparing fit and reliability estimates of a psychological instrument using second-order CFA, bifactor, and essentially tau-equivalent (coefficient alpha) models via AMOS 22. *Journal of Psychoeducational Assessment*, 33(5), 451–472. <https://doi.org/10.1177/0734282914553551>
- 16) Bollen, K. A., & Pearl, J. (2013). Eight myths about causality and structural equation models. In *Handbook of causal analysis for social research* (pp. 301–328). Dordrecht: Springer.
- 17) Bonoli, L., Berger, J.-L., & Lamamra, N. (Eds.). (2018). *Enjeux de la formation professionnelle en Suisse. Le « mod`ele » suisse sous la loupe [Challenges for VET in Switzerland. The Swiss "model" under the microscope]*. Seismo.
- 18) Brantley-Dias, L., & Ertmer, P. A. (2013). Goldilocks and TPACK: Is the construct 'just right? *Journal of Research on Technology in Education*, 46(2), 103–128.
- 19) Byrne, B. M. (2016). *Structural equation modeling with AMOS: Basic concepts, applications, and programming* (3rd ed.). Routledge. <https://doi.org/10.4324/9781315757421>
- 20) Cattaneo, A., & Aprea, C. (2018). Visual technologies to bridge the gap between school and workplace in vocational education. In D. Ifenthaler (Ed.), *Digital workplace learning. Bridging formal and informal learning with digital technologies* (pp. 251–270). Springer. https://doi.org/10.1007/978-3-319-46215-8_14.
- 21) Cattaneo, A., Gurtner, J.-L., & Felder, J. (2022). Digital tools as boundary objects to support connectivity in dual vocational education: Towards a definition of design principles. In I. Zitter, E. Kyndt, & S. Beusaert (Eds.), *At the intersection of (continuous) education and work: Practices and underlying principles* (pp. 137–157). Routledge.
- 22) Chan, S.C. and Lu, M.T. (2004), "Understanding internet banking adoption and use behavior: a Hong Kong perspective", *Journal of Global Information Management*, Vol. 12 No. 3, pp. 21-43.
- 23) Chen, R. (2010), "Investigating models of preservice teachers' use of technology to support student-centered learning", *Computers & Education*, Vol. 55 No. 1, pp. 32-42.
- 24) Chin, W.W. (1998), "The partial least squares approach to structural equation modeling", *Modern Methods for Business Research*, Vol. 295 No. 2, pp. 295-336.
- 25) Cohen, J. (1988), *Statistical Power Analysis for the Behavioral Sciences*, Lawrence Erlbaum, Mahwah, NJ.
- 26) Compeau, D.R. and Higgins, C.A. (1995), "Computer self-efficacy: development of measure and initial test", *MIS Quarterly*, Vol. 19 No. 2, pp. 189-211.

Understanding Digital Technology Integration in Merchant Marine College: Examining Teacher Digital Competency Through TAM Framework

- 27) Davis, F. D., & Venkatesh, V. (1996). A critical assessment of potential measurement biases in the technology acceptance model: three experiments. *International journal of human-computer studies*, 45(1), 19–45. <https://doi.org/10.1006/ijhc.1996.0040>
- 28) Davis, F. D. (1989). Perceived usefulness, perceived ease of use, and user acceptance of information technology. *MIS Quarterly*, 13(3), 319–340. <https://doi.org/10.2307/249008>
- 29) Davis, F. D., Bagozzi, R. P., & Warshaw, P. R. (1989). User acceptance of computer technology: A comparison of two theoretical models. *Management Science*, 35(8), 982–1003. <https://doi.org/10.1287/mnsc.35.8.982>
- 30) Drossel, K., & Eickelmann, B. (2017). Teachers' participation in professional development concerning the implementation of new technologies in class: A latent class analysis of teachers and the relationship with the use of computers, ICT self-efficacy and emphasis on teaching ICT skills. *Large-scale Assessments in Education*, 5 (1), 1–13. <https://doi.org/10.1186/s40536-017-0053-7>
- 31) Davis, F.D. (1986), "A technology acceptance model for empirically testing new end-user information systems: theory and results", doctoral dissertation, Sloan School of Management, Massachusetts Institute of Technology, Cambridge, MA.
- 32) Davis, F.D. (1989), "Perceived usefulness, perceived ease of use, and user acceptance of information technology", *MIS Quarterly*, Vol. 13 No. 3, pp. 319-340.
- 33) Davis, F.D., Bagozzi, R.P. and Warshaw, P.R. (1989), "User acceptance of computer technology: a comparison of two theoretical models", *Management Science*, Vol. 35 No. 8, pp. 982-1003. *JRIT&L* 11,2 188
- 34) Dishaw, M.T. and Strong, D.M. (1999), "Extending the technology acceptance model with task-technology fit constructs", *Information and Management*, Vol. 36 No. 1, pp. 9-21.
- 35) Drennan, J., Kennedy, J. and Pisarski, A. (2005), "Factors affecting student attitudes toward flexible online learning in management education", *The Journal of Educational Research*, Vol. 9 No. 6, pp. 331-338.
- 36) Fishbein, M. and Ajzen, I. (1975), *Belief, Attitude, Intention, and Behavior: An Introduction to Theory and Research*, Addison-Wesley, Reading, MA.
- 37) Fraillon, J., Ainley, J., Schulz, W., Duckworth, D., & Friedman, T. (2019). IEA international computer and information literacy study 2018 assessment framework. Springer Nature. <https://doi.org/10.1007/978-3-030-19389-8>
- 38) From, J. (2017). Pedagogical digital competence—between values, knowledge and skills *Higher Education Studies*, 7(2), 43–50.
- 39) Fornell, C. and Larcker, D. (1981), "Evaluating structural equation models with unobservable variables and measurement error", *Journal of Marketing Research*, Vol. 18 No. 1, pp. 39-50.
- 40) Garson, G. D. (2010). Structural equation modeling example using WinAMOS: The Wheaton study.
- 41) Ghomi, M., & Redecker, C. (2019). Digital competence of educators (DigCompEdu): Development and evaluation of a self-assessment instrument for teachers' digital competence. *CSEDU*, 1, 541–548. <https://doi.org/10.5220/0007679005410548>.
- 42) Gil-Flores, J., Rodríguez-Santero, J., & Torres-Gordillo, J.-J. (2017). Factors that explain the use of ICT in secondary-education classrooms: The role of teacher characteristics and school infrastructure. *Computers in Human Behavior*, 68, 441–449. <https://doi.org/10.1016/j.chb.2016.11.057>
- 43) Grollmann, P. (2008). The quality of vocational teachers: Teacher education, institutional roles and professional reality. *European Educational Research Journal*, 7 (4), 535–547. <https://doi.org/10.2304/eeerj.2008.7.4.535>
- 44) Gu`ardia, L., Maina, M., & Julia`, A. (2017). Digital competence assessment system:
- 45) Supporting teachers with the CRISS platform. In *Central European conference on information and intelligent systems* (pp. 77–82). Faculty of Organization and Informatics Varazdin.
- 46) Ha`m`ala`inen, R., Nissinen, K., Mannonen, J., L`amsa`, J., Leino, K., & Taajamo, M. (2021). Understanding teaching professionals' digital competence: What do PIAAC and TALIS reveal about technology-related skills, attitudes, and knowledge? *Computers in*
- 47) Hair, J.F., Hult, G.T.M., Ringle, C.M. and Sarstedt, M. (2014), *A Primer on Partial Least Squares Structural Equation Modeling (pls-sem)*, Sage Publications, London.
- 48) Hair, J.F., Black, W.C., Babin, B.J., Anderson, R.E. and Tatham, R.L. (2006), *Multivariate Data Analysis*, 6th ed., Prentice-Hall International, Upper Saddle River, NJ.
- 49) Hair, J.F., Black, W.C., Babin, B.J., Anderson, R.E. and Tatham, R.L. (2010), *Multivariate Data Analysis: A Global Perspective*, Prentice-Hall International, NJ.

Understanding Digital Technology Integration in Merchant Marine College: Examining Teacher Digital Competency Through TAM Framework

- 50) Hu, L.T. and Bentler, P.M. (1999), "Cutoff criteria for fit indexes in covariance structure analysis: 'conventional' criteria versus new alternatives. structural equation modeling", *A Multidisciplinary Journal*, Vol. 6 No. 1, pp. 1-55.
- 51) Human Behavior, 117, 106672. <https://doi.org/10.1016/j.chb.2020.106672> International Computer and Information Literacy Study. (2018). International association for the evaluation of educational achievement. ICILS. IEA <https://www.iea.nl/studies/iea/icils>.
- 52) Holden and Rada (2011), "Understanding the influence of perceived usability and technology self-efficacy on teachers' technology acceptance", *Journal of Research on Technology Education*, Vol. 43 No. 4, pp. 343-367.
- 53) Hoyle, R.H. (2011), "Understanding the influence of perceived usability and technology self-efficacy on teachers' technology acceptance", *Journal of Research on Technology Education*, Vol. 43 No. 4, pp. 343-367.
- 54) Kline, R. B. (2016). *Principles and practice of structural equation modeling*. Guilford Press. Krumsvik, R. (2009). Situated learning in the network society and the digitised school. *European Journal of Teacher Education*, 32(2), 167–185. <https://doi.org/10.1080/02619760802457224>
- 55) King, W.R. and He, J. (2006), "A meta-analysis of the technology acceptance model", *Information & Management*, Vol. 43 No. 6, pp. 740-755.
- 56) Krumsvik, R. J., Jones, L.Ø., Øfstegaard, M., & Eikeland, O. J. (2016). Upper secondary school teachers' digital competence: Analysed by demographic, personal and professional characteristics. *Nordic Journal of Digital Literacy*, 11, 143–164, 03.
- 57) Kyndt, E., Beausaert, S., & Zitter, I. (Eds.). (2022). *Developing connectivity between education and work: Principles and practices*. Routledge. <https://doi.org/10.4324/9781003091219>.
- 58) Levin, B. B. (2014). The development of teachers' beliefs. In *International handbook of research on teachers' beliefs* (pp. 60–77). Routledge.
- 59) Lee, Y.-H., Hsieh, Y.-C. and Chen, Y.-H. (2013), "An investigation of employees' use of e learning systems: applying the technology acceptance model", *Behaviour and Information Technology*, Vol. 32 No. 2, pp. 173-189.
- 60) Legris, P., Ingham, J. and Collerette, P. (2003), "Why do people use information technology? A critical review of the technology acceptance model", *Information and Management*, Vol. 40 No. 3, pp. 1-14.
- 61) Lucas, M., Bem-Haja, P., Siddiq, F., Moreira, A., & Redecker, C. (2021). The relation between in-service teachers' digital competence and personal and contextual factors: What matters most? *Computers & Education*, 160, 104052. <https://doi.org/10.1016/j.compedu.2020.104052>
- 62) Luan, W.S., Fung, N.S., Nawawi, M. and Hong, T.S. (2005), "EXperienced and inexperienced internet users among pre-service teachers: their use and attitudes toward the internet", *Educational Technology & Society*, Vol. 8 No. 1, pp. 90-103.
- 63) Marangunić, N., & Granić, A. (2015). Technology acceptance model: A literature review from 1986 to 2013. *Universal Access in the Information Society*, 14(1), 81–95. <https://doi.org/10.1007/s10209-014-0348-1>
- 64) Nistor, N. (2014). When technology acceptance models won't work: Non-significant intention-behavior effects. *Computers in Human Behavior*, 34, 299–300. <https://doi.org/10.1016/j.chb.2014.02.052>
- 65) Nunnally, J.C. and Bernstein, I.H. (1994), *Psychometric Theory*, McGraw-Hill, New York, NY.
- 66) Nunnally, J. C. (1978). *Psychometric theory* (2nd ed.). McGraw-Hill.
- 67) OECD. (2019). *TALIS 2018 results (volume I): Teachers and school leaders as Lifelong learners*. OECD Publishing. <https://doi.org/10.1787/1d0bc92a-en>
- 68) Park, S.Y. (2009), "An Analysis of the technology acceptance model in understanding university students' behavioral intention to use e-learning", *Educational Technology & Society*, Vol. 12 No. 3, pp. 150-162.
- 69) Pynoo, B., Devolder, P., Tondeur, J., van Braak, J., Duyck, W. and Duyck, P. (2011), "Predicting secondary school teachers' acceptance and use of a digital learning environment: a cross-sectional study", *Computers in Human Behaviour*, Vol. 27 No. 1, pp. 568-575.
- 70) Redecker, C. (2017). European framework for the digital competence of educators: DigCompEdu. In Y. Punie (Ed.), *EUR 28775 EN. Publications Office of the European Union*. <https://doi.org/10.2760/159770>.
- 71) Rienties, B., Giesbers, B., Lygo-Baker, S., Ma, H.W.S. and Rees, R. (2016), "Why some teachers easily learn to use a new virtual learning environment: a technology acceptance perspective", *Interactive Learning Environment*, Vol. 24 No. 3, pp. 539-552.
- 72) Reisog˘lu, I., & Çebi, A. (2020). How can the digital competences of pre-service teachers be developed? EXamining a case study through the lens of DigComp and DigCompEdu. *Computers & Education*, 156, 103940.

Understanding Digital Technology Integration in Merchant Marine College: Examining Teacher Digital Competency Through TAM Framework

<https://doi.org/10.1016/j.compedu.2020.103940>

- 73) Sailer, M., Schultz-Pernice, F., & Fischer, F. (2021). Contextual facilitators for learning activities involving technology in higher education: The Cb-model. *Computers in Human Behavior*, 121, 106794.
<https://doi.org/10.1016/j.chb.2021.106794>
- 74) S´anchez-Prieto, J. C., Olmos-Miguel´a´nˆez, S., & Garc´ıa-Penˆalvo, F. J. (2017). Mlearning and pre-service teachers: An assessment of the behavioral intention using an expanded TAM model. *Computers in Human Behavior*, 72, 644–654.
<https://doi.org/10.1016/j.chb.2016.09.061>
- 75) Schaap, H., Baartman, L. K. J., & De Bruijn, E. (2012). Students’ learning processes during school-based learning and workplace learning in vocational education: A review. *Vocations and Learning*, 5, 99–117.
- 76) Scherer, R., Howard, S. K., Tondeur, J., & Siddiq, F. (2021). Profiling teachers’ readiness for online teaching and learning in higher education: Who’s ready? *Computers in Human Behavior*, 118, 106675.
<https://doi.org/10.1016/j.chb.2020.106675>
- 77) Scherer, R., Siddiq, F., & Tondeur, J. (2019). The technology acceptance model (TAM): A meta-analytic structural equation modeling approach to explaining teachers’ adoption of digital technology in education. *Computers & Education*, 128, 13–35. <https://doi.org/10.1016/j.compedu.2018.09.009>
- 78) Scherer, R., & Teo, T. (2019). Unpacking teachers’ intentions to integrate technology: A meta-analysis. *Educational Research Review*, 27, 90–109. <https://doi.org/10.1016/j.edurev.2019.03.001>
- 79) Schumacker, R.E. and Lomax, R.G. (2010), *A Beginner’s Guide to Structural Equation Modeling*, Routledge, New York, NY.
- 80) Schreiber, J. B., Nora, A., Stage, F. K., Barlow, E. A., & King, J. (2006). Reporting structural equation modeling and confirmatory factor analysis results: A review. *The Journal of Educational Research*, 99(6), 323–338.
<https://doi.org/10.3200/JOER.99.6.323-338>
- 81) Schwendimann, B. A., Cattaneo, A. A., Dehler Zufferey, J., Gurtner, J. L., B’etrancourt, M., & Dillenbourg, P. (2015). The ‘Erfahrraum’: A pedagogical model for designing educational technologies in dual vocational systems. *Journal of Vocational Education and Training*, 67(3), 367–396. <https://doi.org/10.1080/13636820.2015.1061041>
- 82) Sime, D. and Priestley, M. (2003), “Student teachers’ first reflections on ICT in classroom learning: implications for initial teacher education”, *Journal of Computer Assisted Learning*, Vol. 21 No. 2, pp. 130-143.
- 83) Strahm, R. H., Geiger, B. H., Oertle, C., & Swars, E. (Eds.). (2016). *Vocational and Professional Education and Training in Switzerland. Success factors and challenges for sustainable implementation abroad*. hep Verlag.
- 84) Swanson, E.B. (1988), “Management information system: appreciation and involvement”, *Management Science*, Vol. 21 No. 2, pp. 178-188.
- 85) Tan, G.W.H., Sim, J.J., OOi, K.B. and Phusavat, K. (2012), “Determinants of mobile learning adoption: an empirical analysis”, *Journal of Computer Information Systems*, Vol. 52 No. 3, pp. 82-91.
- 86) Tondeur, J., Hermans, R., van Braak, J., & Valcke, M. (2008). EXploring the link between teachers’ educational belief profiles and different types of computer use in the classroom. *Computers in Human Behavior*, 24(6), 2541–2553.
<https://doi.org/10.1016/j.compedu.2007.05.003>
- 87) Teo, T. (2010), “A path analysis of pre-service teachers’ attitudes to computer use: applying and extending the technology acceptance model in educational context”, *Interactive Learning Environments*, Vol. 18 No. 1, pp. 65-79.
- 88) Teo, T. (2012a), “EXamining the intention to use technology among pre-service teachers: an integration of the technology acceptance model and theory of planned behavior”, *Interactive Learning Environments*, Vol. 20 No. 1, pp. 3-18.
- 89) Teo, T. and van Schaik, P. (2012b), “Understanding the intention to use technology by preservice teachers: an empirical test of competing theoretical models”, *International Journal of Human-Computer Interaction*, Vol. 28 No. 3, pp. 178-188.
- 90) Thompson, R.L., Higgins, C.A. and Howell, J.M. (1991), “Personal computing: toward a conceptual model of utilization”, *MIS Quarterly*, Vol. 15 No. 1, pp. 124-143.
- 91) Taylor, S. and Todd, P.A. (1995), “Understanding information technology usage: a test of competing models”, *Information Systems Research*, Vol. 6 No. 2, pp. 144-176.
- 92) UNESCO. International Centre for Technical and Vocational Education and Training (UNESCO-UNEVOC). (2020). *Promoting quality in TVET using technology: A practical guide*.

Understanding Digital Technology Integration in Merchant Marine College: Examining Teacher Digital Competency Through TAM Framework

- 93) Valtonen, T., Kukkonen, J., Kontkanen, S., Sormunen, K., Dillon, P., & Sointu, E. (2015). The impact of authentic learning experiences with ICT on pre-service teachers' intentions to use ICT for teaching and learning. *Computers & Education*, 81, 49–58. <https://doi.org/10.1016/j.compedu.2014.09.008>
- 94) Venkatesh, V., & Bala, H. (2008). Technology acceptance model 3 and a research agenda on interventions. *Decision Science*, 39(2), 273–312.
- 95) Venkatesh, V., & Davis, F. D. (1996). A model of the antecedents of perceived ease of use: Development and test. *Decision Sciences*, 27(3), 451–481.
- 96) Venkatesh, V., & Davis, F. D. (2000). A theoretical extension of the technology acceptance model: Four longitudinal field studies. *Management Science*, 46(2), 186–204. <https://doi.org/10.1287/mnsc.46.2.186.11926>
- 97) Venkatesh, V., Morris, M. G., Davis, G. B., & Davis, F. D. (2003). User acceptance of information technology: Toward a unified view. *MIS Quarterly*, 425–478. <https://doi.org/10.2307/30036540>
- 98) Wang, Y.-S., Wu, M.-C. and Wang, H.-Y. (2009), "Investigating the determinants and age and gender differences in the acceptance of mobile learning", *British Journal of Educational Technology*, Vol. 40 No. 1, pp. 92-118.
- 99) Wong, K. T., Teo, T., & Russo, S. (2012). Influence of gender and computer teaching efficacy on computer acceptance among Malaysian student teachers: An extended technology acceptance model. *Australasian Journal of Educational Technology*, 28(7). <https://doi.org/10.14742/ajet.796>
- 100) Yuen, A.H.K. and Ma, W.W.K. (2008), "Exploring teacher acceptance of e-learning", *Asia Pacific Journal of Teacher Education*, Vol. 36 No. 3, pp. 229-243.
- 101) Zarafshani, K., Solaymani, A., D'Itri, M., Helms, M. M., & Sanjabi, S. (2020). Evaluating technology acceptance in agricultural education in Iran: A study of vocational agriculture teachers. *Social Sciences & Humanities Open*, 2(1), 100041. <https://doi.org/10.1016/j.ssaho.2020.100041>
- 102) Zhao, Y., Llorente, A. M. P., & Gómez, M. C. S. (2021). Digital competence in higher education research: A systematic literature review. *Computers & Education*, 104212. <https://doi.org/10.1016/j.compedu.2021.104212>.



There is an Open Access article, distributed under the term of the Creative Commons Attribution – Non Commercial 4.0 International (CC BY-NC 4.0) (<https://creativecommons.org/licenses/by-nc/4.0/>), which permits remixing, adapting and building upon the work for non-commercial use, provided the original work is properly cited.

Leadership in Sports Organizations: An Overview of Indonesia

Jihan Azrina¹, Sumaryanto², Suharjana³

^{1,2,3}Universitas Negeri Yogyakarta



ABSTRACT: This study discusses various leadership approaches that affect organizational performance and human resource development. In this context, the two main approaches analyzed are behavioral and transformational approaches. The behavioral approach focuses on the behavior patterns of leaders which are divided into four systems, ranging from authoritarian exploitation to participative. Meanwhile, the transformational approach emphasizes the ability of leaders to empower their subordinates through changes in values, beliefs, and needs, with the aim of leading the organization towards future success. This study also explores various types of leadership, such as charismatic, paternalistic, militaristic, autocratic, laissez faire, populist, administrative, and democratic, each of which has different characteristics and influences in leading an organization. The concept of effective leadership is considered key to building and maintaining a healthy corporate culture, which in turn can improve overall organizational performance. In the context of sports management, leadership also plays an important role in building character and social skills through sports. The conclusion of this study shows that good leadership can have a positive impact on the organization, by building good relationships between leaders and subordinates and creating a conducive working atmosphere to achieve common goals.

KEYWORDS: Leadership, Behavioral Approach, Transformational Approach, Leadership Type, Sports Management.

I. INTRODUCTION

Leadership has become one of the most debated concepts, but at least not clearly understood in today's study of public and private organizations. (denhardt et al., 2020). An organization or agency can its goal if the people in it can cooperate well in achieving the goal, and the role of the leader is very significant in supporting it to the goal. officers are one of the important elements that are the backbone of the agency, because the officers are involved in determining the advance of the retreat of an agency. Therefore, in the performance of the duties and responsibilities of the staff required persistence, rigour, competence, ability to perform tasks and other expertise that can generally support the achievement of the goals of the organization. (Yancomala, 2020).

The role of leadership as the controller of an organization and the role of the subordinate as the executor of tasks in achieving the goals of the organization is an inseparable synergy. Especially for members of state/government organizations, they should do their job well in order to give the best to the community. Leadership is the ability to influence a group to a vision or goal. (Robbins & P Stephen, 2011). According to Oemar (2001) someone who occupies a leadership position in the management of an organization has an important role, not only internally for the organization concerned but also in the face of the outside of the organization. These roles are: role as a catalyst, role as an facilitator, problem solver, source connector, and role as communicator.

A leader's leadership style is a set of habits that they use to shape the actions of others around them. There are advantages and disadvantages of each of these approaches. A leader's approach to leadership will be shaped by a unique set of skills and character. (Marzuki, 2022). Leadership is the style of a leader to influence his subordinates to cooperate and work effectively according to his orders. According to Yukl (2005) in addition to characteristics a good leader should have an important influence and role in doing the following: (1) Motivating members to goals (2) Mutual trust and cooperation amongst members (3) Learning and sharing new knowledge among members (4) Organizing work activities (5) Achieving goals and strategies achieved (6) Developing trust and skills among members. Leadership indicators according to Chapman in (Gitosudarmo et al, 1997) are ways of communicating, giving motivation, leadership, decision-making and positive power.

Leadership in Sports Organizations: An Overview of Indonesia

Being a leader of a sports organization is not an easy job. Some skills must be possessed in order for leadership to succeed because a person's success in leading a sporting organization is determined by the managerial skills he possesses, among others; leadership skills, constructive skills, organizational skills, and financial management skills. It is consistent with what was submitted by: (Mochamad S, 2015), (Ibrahim et al, 2015). (Agus Abdillah, 2013). In addition, a manager must have innovation and have a high commitment to leadership, have pro-innovation characteristics, have organizational ability and be able to run carefully organized. (Larena Hoeber, 2012).

The sport management capacity of a person will indicate the degree of one's success in leading a sporting organization. Because in a sports organization there are many areas that are important parts that must be controlled in order to be used as a tool to a goal. The ultimate goal of sport management is the success of its athletes in participating in the championship both nationally and internationally. As presented by (Agung Nugroho,2010), (Rizaldi,2015), (Setio Nugrho,2016). (Nurul Hidayah,2016) The management theory that supports the success of sports management among others; Planning, Organizing, Coordinating, Motivating, Controlling, Directing, Staffing, Innovation, Representation, Supervising, Communicating, Actuating, Appraising, Commanding, Reporting, Executing, and Budgeting. (Utomo Budi,2015).

II. LITERATURE

LEADERSHIP

Every leader has a different leadership style in his leadership on the organization. Effective leadership style in increasing productivity through situational leadership. According to Miftah Toha (1983) the two codes of duty and relationship behavior that are central to the concept of situational leadership will be explained as follows: (1) duty behaviour is the code of conduct of a leader to regulate and formulate the roles of the members of the group or followers; describes the activities to be done by each member, when to do, where to perform them, and how the task should be achieved.

The concept of leadership is so broad, ranging from definitions to other things that are closely related to leadership. "Leadership is the process by which one individual influences or her group members toward the achievement of defined group or organizational goals" (Kreitner & Kinicki, 2005). (A Robert Baron,2003). According to Mc Shane (2005) leadership is the ability to influence, motivate and enable others to contribute to the effectiveness and success of the organization in which they are members. The Great Person Theory based on A. Robert Baron (2003) is "The View that leader processes special that set them a part from others and that these traits are responsible for their assuming positions of power and authority". From the above definition, the theory of great people is a perspective in which leaders have special qualities that are different from others.

Leadership is a continuous process, with the achievement of one goal being the beginning of a new goal. A leader in an organization or group has a duty to draw their power and influence from sources outside the group, and in most cases, has been given some power to perform tasks, and to give reward and punishment based on performance. Presents can include compliments, real benefits. On the other hand, leaders who don't have the authority to give praise can try to make it by giving praise and compliments and making promises that they can't keep. In performing his functions and roles as a leader, a leader usually applies a style or approach in running the organization he leads. A leader can apply any approach or style that is characteristic of the leader. An effective leader influences followers in order to the desired goal. Differentiated types of leadership can influence the effectiveness or performance of an organization. (Nanjung deswaraswamy, 2014). Therefore, the leadership role in the organization is influenced by the style of leadership it adopts.

III. METHODS

This research belongs to the study of literature by finding the theoretical references corresponding to the phenomena found. The theory references obtained through research through literature studies that are the basis and the main tool for the practice of research in the field. Literature studies are the way used in gathering data or sources related to the theme in research. Studies of literature can be obtained from a variety of sources, journals, documentary books, the Internet and libraries.

IV. DISCOURSE

Leadership styles

The dimensions of leadership style according to Hersey & Blanchard (1995) are as follows: (1) Duty behavior is the extent to which a leader gives instructions to his people: by telling them what to do, when to do it, where to do that, and how to do this. It means that leaders set goals and set their roles. (2) Relational behaviour is the rate to which leaders make two-way relationships with their people: providing support, encouraging psychological suggestions and facilitating behavior. It means the leader actively supports and supports the efforts of his people in the execution of their work.

Leadership in Sports Organizations: An Overview of Indonesia

Hersey and Blanchard in (Sunyoto, 2012) leadership is any attempt of someone who tries to influence the behavior of a person or group, an attempt to affect this aimed at achieving individual goals, friends' goals, or jointly with organizational goals that may be the same or different. Stoner in (Pasolong, 2010) says that a leadership style is a variety of patterns of behavior preferred by a leader in the process of directing and influencing employees. Sunyoto (2012) argues that a task-oriented leadership style is characterized by (1) a leader giving guidance to subordinates, (2) a leader strictly overseeing the performance of official duties. Indicators of leadership style are: (a) preparing a work plan, (b) providing guidance to staff, (c) monitoring the performance of staff duties, (d) motivating the subordinate, (e) involving subordinates in decision-making, (f) developing friendly relationships. As for the diversity of leadership style is;

1) Continuous leadership style

There are seven models of decision-making styles by leaders. These seven models are still in the framework of the two authoritarian and democratic styles he pocketed. The seventh model of decision of the leader is described as follows: (1) The leader makes a decision and then announces it to his subordinates. From this model it is seen that the authority used by the superior is too much while the area of freedom of the inferior is very narrow. (2) The leader sells decisions. In this case the leader still appears to use much of the authority he has, so exactly with the first model. The bottom here hasn't been much involved in decision-making. (3) The leader gives thoughts or ideas and invites questions. In this model, leaders have already shown progress, because mutatis the use of authority funds gives an opportunity to subordinates to raise questions. The bottom is a little involved in decision-making. (4) The leader gives a temporary decision that is susceptible to change. The subordinates have begun to be much involved in decision-making, while the authority of the leader has started to be reduced in its use. (5) The leader asks questions, asks for advice and makes decisions. The model is clear, the leadership authority is used as little as possible, instead the freedom of subjection in participating in decision-making has been used a lot.

2) The Grid Managerial Style According to Blake and Mouton,

There are four styles of leadership that are grouped as extreme, while the others are only one that is said to be in the middle of these extreme styles. As far as the style is concerned, (1) At Grid 1.1, the manager makes very little effort to think about the people who work with him, and the production that his organization is supposed to produce. In carrying out the duties of the manager in this grid considers himself as an intermediary who only communicates information from the superior to the inferior. (2) On Grid 9.9, the manager has a high sense of responsibility to think about both the production and the people who work with it. He tries to plan all his ventures with his dedication to the production and fate of the people working in his organization in mind. The manager who belongs to this grid can be said to be a "team manager" who rill (the real team manager). Manger blends the production needs with the needs of the peasants individually. (3) On Grid 1.9, the leadership style of this manager is to have a high sense of responsibility to always think of the people who work in his organization. But he's thinking about low production. Managers of this kind are often called club leaders. (the country club management). This manager is trying to create an environment where everyone can work relaxed, friendly, and happy in their organization. In an atmosphere like this, no one wants to think about coordinating efforts to the goals of the organization. (4) In Grid 9.1, managers are sometimes referred to as managers who carry out their duties autocratically. (autocratic task managers). This type of manager just wants to think about the effort to improve the efficiency of the execution of work, has no or only little sense of responsibility on the people who work in his organization. More than that, more outstanding his autocratic style of leadership, (Thoha; 2010).

Concept of leadership approach

Speaking of the topics of leadership, very often we hear about the concepts of Western leadership approaches, such as charismatic leadership; transformational leadership: transactional leadership. Behavioral Approach; and other leadership concepts.

Charismatic Leadership Approach

Charismatic leadership is leadership that assumes that charisma is the individual characteristic of a leader, which can distinguish him from other leaders, especially in terms of implications for the inspiration, acceptance, and support of the subordinates. (Griffin, 2016,; Sule & Saefullah, 2013,). This charismatic leadership has been running since ancient Greece. Charismatic leadership analysis. Then Robert House in Fred Luthan (1998) stated the characteristics of charismatic leadership are: 8 (1) Have confidence and confidence in followers; (2) High expectations for follower; (3) Have an ideological vision; (4) Have a common vision and mission with a leader; (5) Have extreme loyalty and trust in the leader; (6) Have a race to follow the system of values and behaviour of a leadership; (7) Relating to a leader is self-esteem; (8) Charismatic leaders have great debating and persuasive abilities, attitudes, and behaviors that can influence their followers.

Leadership in Sports Organizations: An Overview of Indonesia

Characteristic Leadership Approach

Leaders and non-leaders can be examined by identifying their leadership traits. This psychological approach, based on the general recognition that individual attitudes are based on personality structures. This approach describes a characteristic of a leader: having physical strength and hospitality. Leaders have a high level of intelligence. There are personality traits that can be seen that have a positive relationship with the leadership attitude and have a high relationship: popularity, authenticity, adaptability, ambition, persistence, social status, economic status, ability to communicate. Although the criteria of leadership have not been fully determined by the experts, there are a number of personality qualities that leaders should possess; (Andy Undap, 1989) among them: (1) extensive general education, having the ability to develop leadership skills; (2) mental maturity, which can be seen in emotional stability, not easily offended and angry; (3) curiosity, creative thinking and innovative; (4) analytical ability, able to analyze the symptoms of information available; (5) integrative, integrated personality and not plin-plin (plin-plin) by any party; (6) communication skills, capable of communicating with others; (7) rational and objective, healthy thinking; not choosing love & non-emotional; (8) simplicity, showing simplicities and working efficiently; (9) nature of courage, having courage in making fair decisions.

Behavioral Approach

This approach can be reviewed on the model of leadership behavior that influences its employees. This leadership behavior can be centered on duty or on employee relationships. Rensis Likert developed leadership theory on two dimensions, task orientation and subordinate orientation, which is described as four levels of leadership effectiveness patterns. According to this theory, leadership encompasses four systems: (1) Exploitative authoritative, no trust in the subordinate and always using threats on the employee; (2) Benevolent authoritative, there is communication but only a few; (3) Consultative, the decision-making process for important things remains in the hands of the leader but trust is the basis of communication; (4) Participative, is an ideal system and there is full trust of the direct superiors. Communications are very open, relationships between employees are smooth, and the company's condition always looks healthy and fresh.

Transformational approach

A transformational leader is a leader's ability to empower people to be able to adapt to the environment for future success. (Sule & Saefullah, 2013). Charismatic leaders can make a shift from traditional organizations to modern organizations. This is the process of transformation that is the basis of the transformational theory. In the leadership of this transformational form, the leader shifts the system of values, beliefs and needs of his followers. According to Bernard M. Bass's research quoted by Fred Luthan (1998). "Transactional leadership is a prescription for mediocrity and that transformational leadership leads to superiority. Performance on organization facing demand for renewal and change Transactional Leadership is leadership that sideways bad to excellent organizational performance, through innovation and improvement. This transformation process can be carried out through recruitment, selection, promotion, training and development, health assurance and organizational performance effectiveness. According to Bass, effective transformational leaders have the following characteristics: (1) Leaders identify themselves as agents of change; (2) Leaders are people who can give impetus; (3) Leader is someone who is confident in others; (4) Leader drives a system of values; (5) Leaders are lifelong learners; (6) Have the ability to adapt to complexity, ambiguity and uncertainty, and (7) Have a vision.

Leadership types

The leader has his own unique habits, character, temperament, character and personality, so it is his behavior and style that distinguishes him from others. This style of life will definitely color my behavior and leadership, so that some kind of leadership will emerge. Kartono (1991) divides the type of leadership into several types, namely:

- 1) Charismatic type** Until now, experts have not managed to figure out why a leader has charisma. It is known that such a leader has a great attraction, although the followers often cannot explain why they follow the leader.
- 2) paternalist type** A paternalist leader is a person who has the following characteristics: (a) considers his subordinate to be an immature human being; (b) is overly protective; (c) rarely gives the subordinates a chance to make a decision; (d) seldom gives the subject the opportunity to take the initiative; (e) has rarely given the subject an opportunity to develop his creativity and imagination; and is often wise.
- 3) Militaristic type** A military leader is a leader who has the following attributes: (a) in advancing a system of orders that is more commonly used, (b) in mobilizing a subordinate who is happy to depend on his rank and office, (c) pleased with excessive formalities, (d) demands high and rigid discipline from his subordinates, (e) is difficult to receive criticism from his undersigns, (f) admired ceremonies for various circumstances.

Leadership in Sports Organizations: An Overview of Indonesia

- 4) **Otakrasi type** An autocratic leader is a leader who possesses the following criteria; (a) considers an organization to be personal property; (b) identifies a personal purpose with an organization's purpose; (c) regards subordinates as a mere tool; (d) is unwilling to accept criticism of advice and opinions; (e) relies too much on his formal authority; (f) in his actions often uses an unsure approach of coercion and punishment.
- 5) **Laissez Faire type** This type of leader doesn't lead, he lets his group and everyone do their own thing. The leader did not participate at all in the activities of his group. All the work and responsibilities must be carried out by his own subordinate, he is a symbolic leader, and usually has no technical skills, because his seat as a leader is usually acquired through bribery or nepotism.
- 6) **Populist type** This type of leader holds firmly to the values of traditional societies, and emphasizes the issue of national unity or nationalism and is very cautious of colonialism and oppression of oppression and domination by foreign powers. This kind of leadership prioritizes revitalization or nationalism and is closely linked to traditional modernity.
- 7) **Administrative type** This leadership is capable of carrying out administrative tasks effectively. Its leaders are made up of technocrats and administrators who are capable of driving the dynamics of modernization and development. This the administrative and bureaucratic systems that are effective to rule, that is, to consolidate the integration of the nation in particular, and the development effort in general, can be dismantled. With this kind of leadership, advanced administrative technology can be expected.
- 8) **Democratic type** Democratic leadership is human-oriented and provides effective guidance and there is coordination of work on all subordinates, with emphasis on internal responsibility (on oneself) and good cooperation. Knowledge of leadership has proved that the democratic type is the most suitable for modern organizations as they are today. This is because this type of leadership has the following characteristics: (a) in the process of subordinate movement is always a point of rejection of the opinion that man is the noble being in the world, always striving to synchronize the interests and purposes of the organization with the personal interest and purpose rather than his subordinates, (b) is happy to receive advice, opinions, and even criticism from his subjects, (c) always seeks to prioritize cooperation and teamwork in the pursuit of a goal, (d) sincerely gives the broadest freedom to his submissive who commits a mistake which is then corrected so that his submission no longer commits the same mistake, (e) always tries to make his subjugate more than successful to him, (f) and tried to develop his personal capacity as a leader. From the above view, it can be concluded that the different styles and types of leadership depending on habits, character, personality, education and the style of (g) everyday life greatly influence one's leadership style.

The truth of sports management

Sports Management has been internationally recognized as one of the potential for developing citizenship and leadership. What citizenship means here is behavior, attitude, values, rules, and customs/traditions. Furthermore, through Sports Education can be focused on attention to things that are fair play, respect all participants, respect for all abilities, development of leadership and social skills, and in the challenge given to students to work collaboratively, so Sports Education seems to be an important means for Citizenship Education. Specific roles in sports management also provide an opportunity to empower sports players to take greater responsibility for their own learning and actively support learning for others. Leaders, athletes, coaches, fitness instructors, heating coordinators, officials, statisticians and other sportsmen.

Meanwhile, in the Law of the Republic of Indonesia No. 3 of 2005 on the national sports system, in chapter 1, article 1, paragraph 5, it is stated that a sporting community is: "any person and group of people who are directly involved in sporting activities that include a fitness worker, a Builder, and an athlete". Further, in paragraphs 6, 8 and 9 it is explained that: A sports worker is a person who exercises in an attempt to develop physical, spiritual and social potential. "A sports builder is someone who has interests and knowledge, leadership, managerial ability, or funding dedicated to the construction and development of sports".

According to the United Nations, a number of values exist and can be learned through sports activities include: cooperation, communication, respect for the rules, problem solving, understanding, connection with others, leadership, respect of others, value of effort, how to win (strategy to win), how to lose (strategies to lose) how to manage competition, fairplay, sharing, self-esteem, trust, honesty (honesty), self-respect, tolerance, resilience, teamwork, discipline and confidence.

Leadership can be conceptualized as an interaction between a person and a group. Each individual in interaction can play a role and somehow these roles must be aligned with each other. The basis of the election is the influence that one in this case is the leader who influences, while others respond. A leader can be called a motorcycle. Leadership in the organization is something that is required in life so that life becomes orderly and justice can be applied. A leader has a duty of understanding and dealing with the condition of a leader's followers and motivating them to work harder. Leadership in an organization is

Leadership in Sports Organizations: An Overview of Indonesia

crucial because in good and effective leadership skills aimed at building, encouraging and introducing a strong company culture so that it can success. Effective leadership requires productivity, satisfaction of work, group cooperation, employee spirit and good coordination in order to the goals of the organization. Developing confidence in leadership is the duty and responsibility of a leader. In such leadership there are supportive components among them the presence of a leader, the ability of the leader to promote the achievement of the goals of the organization, followers, that is, people under the authority of the leadership, there is a direction to be obtained, and there is an organization where such a leadership exists.

V. CONCLUSION

A leader in fact is someone who has the ability to influence the behavior of others in his work by using power. In his activity that the leader has the power to deploy and influence his subjects in relation to the tasks to be performed. An organization must have a leader. Without a leader in the organization will not be able to walk with as it should because no one leads and directs the organization. A leader is a positive and confident person who has a high vision, mission and ethical values, with the ability to convey ideas and is capable of encouraging and relating well with others. So one's expertise is essential in leading an organization, but when one's expertise cannot meet the category to be a leader then the person must be able to develop himself to be capable of practicing and learning to become a leader. Leadership will be the determining factor of success in an organization. This is because leadership is the centerpiece of significant change in the organization. Leadership is to be an influential personality and leadership was the art of creating organizational suitability and stability.

The task of the leader in his leadership includes; immersing the needs of the group, from that desire can be drawn realistic and truly achievable wills, convincing his group of what is their will, what is realistic, and what is actually fiction. A professional leader is a leader who understands his duties and responsibilities, and is able to establish a good cooperative relationship with his subordinates, thus creating an atmosphere of work that makes the subordinate feel safe, calm, and have a freedom in developing his ideas in order to a common goal that has been set.

REFERENCES

- 1) Ahmad, R., & Pratama, A. (2021). Faktor manajemen profesional: perencanaan, pengorganisasian, dan pengendalian (suatu kajian studi literatur manajemen sumberdaya manusia). *Jurnal Ilmu Manajemen Terapan*, 2(5), 699-709.
- 2) Andy PP Undap. 1989. Pengaruh gaya Kepemimpinan dan Motivasi Kerja terhadap Penampilan Kerja Guru SPG di Manado dan Minahasa. Tesis PPS IKIP Bandung: tidak diterbitkan.
- 3) Frinaldi, A. (2023). Pengaruh Kepemimpinan terhadap Kepuasan Kerja. *JIM: Jurnal Ilmiah Mahasiswa Pendidikan Sejarah*, 8(2), 506-518.
- 4) Kartono K., 2001, Pemimpin dan Kepemimpinan, PT. Raja Grafindo Persada.
- 5) Latifah, Z. (2021). Pentingnya Kepemimpinan Dalam Organisasi. *Proceeding: Islamic University of Kalimantan*.
- 6) Luthan, Fred. 1998. Organizational Behavior. 8th Ed, Irwin, Mc Graw-Hill.
- 7) Lubis, A. S., & Wulandari, S. (2018). Pengaruh Employee Engagement dan Kepemimpinan terhadap Kinerja Pegawai pada Dinas Pariwisata, Budaya, Pemuda dan Olah Raga Kabupaten Serdang Bedagai. *Jurnal Manajemen Dan Keuangan*, 7(1), 82-89.
- 8) Nurharirah, S., & Effane, A. (2022). Hambatan dan Solusi dalam Manajemen Sarana dan Prasarana Pendidikan. *Karimah Tauhid*, 1(2), 219-225.
- 9) Griffin, Ricky W. 2016. Fundamentals of Management. 8th ed. Boston, USA: Cengage Learning.
- 10) Hafidzi, M. K., Zen, A., Alamsyah, F. A., Tonda, F., & Oktarina, L. (2023). Pengaruh Gaya Kepemimpinan, Lingkungan Kerja, dan Kompensasi Terhadap Kinerja Karyawan dengan Motivasi Sebagai Variabel Intervening (Literature Review Manajemen Sumber Daya Manusia). *Jurnal Ekonomi Manajemen Sistem Informasi*, 4(6), 990-1003.
- 11) Hidayatullah, N., Marsidin, S., & Sulastri, S. (2022). Studi Literatur: Manajemen Kelas untuk Meningkatkan Motivasi Belajar Siswa. *Jurnal Pendidikan Dan Konseling (JPDK)*, 4(6), 10980-10986.
- 12) Putra, Z., & Ma'ruf, J. J. (2020). Konsep Kepemimpinan Teuku Umar dalam Konteks Ilmu Manajemen Kontemporer: Sebuah Tinjauan Literatur. *Jurnal Bisnis Dan Kajian Strategi Manajemen*, 4(2).
- 13) Rawe, A. S. (2018). Analisis Manajemen Dinas Pendidikan Pemuda Dan Olahraga Dalam Meningkatkan Prestasi Olahraga di Kabupaten Ende. *SPORTIVE: Journal Of Physical Education, Sport and Recreation*, 1(2), 1-17.
- 14) Rosadi, D. (2018). Gaya kepemimpinan pelatih dalam penerapan sistem pengendalian manajemen dalam klub Bintang Timur Surabaya. *CALYPTRA*, 7(1), 556-569.
- 15) Robbins. P.S., 2002, Prinsip-prinsip Perilaku Organisasi. Jakarta. Edisi kelima, Jakarta.

Leadership in Sports Organizations: An Overview of Indonesia

- 16) Setiawan, Y. (2010). Pengaruh gaya kepemimpinan dan budaya organisasi terhadap produktivitas kerja pegawai dinas olah raga dan pemuda provinsi jawa barat. *Jurnal Manajerial*, 9(2), 79-90.
- 17) Sujana, D. (2018). Dampak Simultan Manajemen Sarana Prasarana dan Peran Kepemimpinan Terhadap Pembangunan Olah Raga. *Jurnal Ilmu Administrasi: Media Pengembangan Ilmu dan Praktek Administrasi*, 15(1), 116-132.
- 18) Sule, Ernie Tisnawati, and Kurniawan Saefullah. 2013. Pengantar Manajemen. 1st ed. Jakarta: Kencana (Prenada Media Group).
- 19) Sunarno, A., Damanik, S., & Heri, Z. (2018). Peningkatan kapasitas manajemen olahraga pengurus provinsi cabang olahraga di sumatera utara. *Jurnal Ilmu Keolahragaan*, 17(1), 1-4.
- 20) Widakdo, S., Ramli, A. T., & Ardiasih, L. S. (2022). Pengaruh Kepemimpinan, Motivasi, Dan Pemberian Insentif Terhadap Kinerja Pegawai Pada Kantor Dinas Pendidikan Kebudayaan Pemuda Dan Olahraga (Dikbudpora) Kabupaten Bima. *Scientific Journal Of Reflection: Economic, Accounting, Management And Business*, 5(3), 544-552.
- 21) Yancomala, O. (2020). Hubungan gaya kepemimpinan dengan motivasi kerja pegawai di Dinas Pemuda dan Olahraga Provinsi Sumatera Barat. *Jurnal Bahana Manajemen Pendidikan*, 2(1), 534-541.
- 22) Yahya, M. (2015). Kompetensi dan gaya kepemimpinan personaliti komunitas olahraga di provinsi aceh. *Jurnal Administrasi Pendidikan: Program Pascasarjana Unsyiah*, 3(3).



There is an Open Access article, distributed under the term of the Creative Commons Attribution – Non Commercial 4.0 International (CC BY-NC 4.0)

(<https://creativecommons.org/licenses/by-nc/4.0/>), which permits remixing, adapting and building upon the work for non-commercial use, provided the original work is properly cited.

Visual Pollution: Causes, Health Impacts, And Mitigation Strategies for Enhancing Environmental Aesthetics and Public Well-Being – A Review



Najmaldin Ezaldin Hassan¹, Sonia Khalil²

¹College of Engineering, Civil and Environment Department, University of Zakho, Kurdistan region, Iraq

²City, University of London, United Kingdom

ABSTRACT: This review paper examines visual pollution, its causes, and impacts on human health and well-being, defined as unattractive and disruptive visual elements in the environment that degrade aesthetic quality. It explores sources such as billboards, litter, industrial structures, and poorly planned urban development. The paper discusses how rapid urbanization, industrialization, and excessive advertising exacerbate visual clutter, particularly in urban areas.

The impacts of visual pollution on health are significant, including increased stress, anxiety, and diminished quality of life. Vulnerable populations, such as lower-income communities, children, and the elderly, face heightened risks due to greater exposure. The review highlights disparities in exposure and health outcomes, emphasizing that the cumulative effects of visual pollution and socio-economic disadvantages intensify its negative impact.

The paper also evaluates strategies for mitigation, including urban planning measures like green spaces and zoning regulations, as well as regulatory approaches to manage outdoor advertising and waste. By addressing visual pollution through comprehensive planning and regulation, the paper aims to inform policies that enhance environmental aesthetics and improve public well-being.

KEYWORDS: Visual pollution; Health impacts; Public well-being; Mitigation strategies; urban planning; Green spaces

1. INTRODUCTION

1.1 Definition of Visual Pollution

Visual pollution refers to the unattractive and undesirable visual elements in a landscape that disrupt the aesthetic appeal of an area. Unlike other forms of pollution, visual pollution does not necessarily pose a direct threat to human health, but it can have significant psychological and social impacts (Sagvan et al., 2019). Visual pollution occurs when human activities alter the visual environment in ways that are intrusive or damaging to the natural or built surroundings (Nasar, 1994). It includes any unattractive, overwhelming, or discordant visual stimuli in the environment that reduce its visual quality, leading to a degraded perception of an area (Sima, 2010).

1.2 Components of Visual Pollution

1.2.1 Billboards

Billboards are one of the most common forms of visual pollution, particularly in urban areas. These large, visually intrusive advertisements often clutter cityscapes and natural environments, detracting from the aesthetic appeal of both (Zacharias, 2001). The proliferation of billboards, especially when poorly regulated, can overwhelm public spaces and natural vistas, leading to a fragmented and chaotic visual experience (Shanmugathas, 2018). Billboards can also contribute to the desensitization of the public to visual stimuli, making it harder for meaningful or necessary signage to stand out (Kavaratzis, 2005).

1.2.2 Power Lines

Power lines are another significant contributor to visual pollution, especially when they cut through otherwise scenic landscapes. The presence of overhead power lines can disrupt the natural beauty of rural areas and parks, creating a sense of industrial intrusion (Palmer, 2004). The visual impact of power lines is often a point of contention in environmental planning, as they are necessary for infrastructure but can significantly reduce the visual quality of the environment (Hull & Bishop, 1988). The negative

Visual Pollution: Causes, Health Impacts, And Mitigation Strategies for Enhancing Environmental Aesthetics and Public Well-Being – A Review

perception of power lines is amplified in areas where they are densely clustered or where high-voltage lines are prominent (Sumper et al., 2021).

1.2.3 Buildings

The design and placement of buildings can also contribute to visual pollution, particularly when they clash with the surrounding environment or are poorly maintained. Skyscrapers and large commercial buildings can dominate the skyline, casting shadows and blocking views of natural features like mountains or rivers (Nasar, 1992). The aesthetics of a building, including its color, shape, and size, play a crucial role in how it is perceived by the public and whether it is seen as a form of visual pollution (Purcell, Peron, & Berto, 2001). Moreover, buildings that are not in harmony with the local architectural style or are dilapidated can create a sense of visual disarray (Stamps, 2013).

1.2.4 Litter

Litter is a pervasive and noticeable form of visual pollution that affects both urban and natural environments. The presence of litter, such as plastic bags, bottles, and other waste, can severely diminish the visual appeal of an area and create a sense of neglect and disorder (Campbell, 2007). Litter not only detracts from the aesthetics but also signals environmental degradation and can lead to further pollution as it accumulates (Schultz et al., 2013). The perception of an area as dirty or poorly maintained due to litter can also influence public behavior, leading to a cycle of ongoing littering (Rathje & Murphy, 2001).

1.3 Growing Concerns Regarding Visual Pollution

1.3.1 Rapid Urbanization and Its Impact on Visual Pollution

Rapid urbanization has significantly contributed to the increase in visual pollution, particularly in developing countries where urban growth is often unplanned and uncontrolled. As cities expand, the demand for housing, infrastructure, and commercial spaces leads to the construction of buildings and facilities that may not always be aesthetically pleasing or well-integrated into the existing environment (Pacione, 2009). The lack of coordinated urban planning can result in haphazard development, with buildings, billboards, and other structures cluttering the urban landscape and reducing its visual appeal (Angel, 2012). This uncontrolled growth often prioritizes economic gains over environmental and aesthetic considerations, leading to a visually chaotic urban environment.

1.3.2 Industrialization and the Proliferation of Visual Pollution

Industrialization has further exacerbated visual pollution, especially in regions where industries are densely concentrated. The construction of factories, power plants, and other industrial facilities often results in large, visually intrusive structures that dominate the landscape (Lynch, 1960). Additionally, industrial activities frequently lead to the accumulation of waste, both solid and airborne, which can contribute to the degradation of the visual environment (Bordenave & Lung, 1996). The presence of industrial facilities in urban areas not only impacts the aesthetic quality of the environment but also affects the overall livability of cities, as residents are forced to contend with both visual and environmental pollution.

1.3.3 The Role of Advertising in Visual Pollution

The rapid growth of urban areas has also led to a significant increase in outdoor advertising, contributing to visual pollution. Billboards, neon signs, and other forms of outdoor advertisements have become ubiquitous in cities, often overwhelming public spaces and natural vistas (Azumah, 2021). The unregulated proliferation of these advertisements creates a cluttered visual environment that can detract from the aesthetic quality of urban areas and lead to a sense of visual chaos (Widyo Harsanto & Raras Satuti, 2023). Moreover, the emphasis on commercial messaging in public spaces often marginalizes other forms of visual communication, reducing the diversity of visual experiences available to urban residents.

1.3.4 Environmental and Psychological Impacts of Visual Pollution

The increasing visual pollution due to urbanization and industrialization has significant environmental and psychological impacts. Visually cluttered environments can lead to decreased quality of life, as they contribute to stress and anxiety among urban residents (Swanwick, 2009). The loss of natural landscapes and the dominance of industrial and commercial structures in the visual environment can also reduce people's connection to nature, leading to a sense of alienation and disconnection from the environment (Ulrich, 1984). Additionally, the presence of visual pollution in urban areas can diminish property values and reduce the attractiveness of cities as places to live and work.

1.3.5 Global Concerns and the Need for Regulatory Measures

The growing concerns regarding visual pollution are not confined to any one region but are a global issue that requires concerted efforts to address. Internationally, there is increasing recognition of the need for regulations and planning measures to manage visual pollution, particularly in rapidly urbanizing areas (Habitat, 2013). Effective urban planning, stricter regulations on outdoor advertising, and the incorporation of aesthetic considerations into industrial and infrastructure projects are essential to mitigating

Visual Pollution: Causes, Health Impacts, And Mitigation Strategies for Enhancing Environmental Aesthetics and Public Well-Being – A Review

the impacts of visual pollution (Berleant, 1997). The challenge lies in balancing economic development with the need to preserve the visual quality of urban and natural environments.

1.4 Understanding the Impact of Visual Pollution on Human Health and Well-Being

Visual pollution, characterized by the presence of unattractive and chaotic visual elements in the environment, has been shown to impact psychological well-being and mental health. Studies have found that exposure to visually cluttered environments can lead to increased levels of stress, anxiety, and depression (Swanwick, 2009). By examining existing literature, this review aims to understand how visual pollution contributes to mental health issues and the extent of its impact on different populations.

The aesthetic quality of the environment plays a crucial role in shaping individuals' experiences and satisfaction with their surroundings (Porteous, 2013). This review will assess how visual pollution, including the presence of billboards, industrial structures, and litter, affects people's perceptions of their environment and their overall sense of well-being. Understanding these impacts can help in developing strategies to enhance the visual quality of urban spaces and improve residents' quality of life.

Certain groups, such as those living in densely populated urban areas or low-income communities, may be more exposed to visually polluted environments and thus more susceptible to its negative impacts (Evans, 2003). This review will highlight disparities in exposure and the resulting health outcomes. This understanding can guide targeted interventions to mitigate the effects of visual pollution on vulnerable populations.

Urban planning and environmental policies play a significant role in managing visual pollution, yet the success of these strategies varies widely (Sancar, 2009). This review will examine existing approaches, such as zoning regulations, aesthetic guidelines, and public awareness campaigns, to determine their effectiveness in improving visual environments and mitigating the negative impacts on health and well-being. By identifying successful strategies, this review will provide insights for future policy development.

2. SOURCES OF VISUAL POLLUTION

2.1 Urban Development

2.1.1 High-Density Buildings

High-density buildings, especially in urban areas, significantly contribute to visual pollution. The proliferation of skyscrapers and other large structures often leads to a cluttered skyline, obstructing natural views and creating a sense of visual chaos. Studies have shown that the visual dominance of tall buildings can negatively affect residents' perception of their environment, leading to decreased satisfaction and increased stress levels (Punter, 2007). The lack of architectural coherence in high-density areas further exacerbates these effects, as a mix of styles and scales can create a jarring and aesthetically displeasing urban landscape.

2.1.2 Poorly Designed Infrastructure

Poorly designed infrastructure, including roads, bridges, and utility installations, is another major contributor to visual pollution. When infrastructure lacks consideration for aesthetic and environmental integration, it can dominate the visual field and disrupt the harmony of the surrounding environment. This is particularly evident in areas where infrastructure projects are executed without proper urban planning, resulting in visual clutter and a disjointed landscape (Nasar, 1990). The absence of green spaces or aesthetically pleasing elements in infrastructure design often leaves residents feeling disconnected from their environment, contributing to a decline in overall well-being.

2.1.3 Overcrowded Spaces

Overcrowded spaces, characterized by a high density of people, vehicles, and structures, also play a significant role in visual pollution. In densely populated urban areas, the sheer volume of signage, advertisements, and uncoordinated building designs can overwhelm the senses, leading to visual fatigue and reduced quality of life (Appleyard, 1979). The constant presence of crowds and congestion further detracts from the visual appeal of an area, making it difficult for residents and visitors to find respite from the visual noise. This over-saturation of visual stimuli in overcrowded spaces can contribute to mental health issues, including stress and anxiety.

2.1.4 Combined Effects and the Need for Integrated Urban Planning

The combined effects of high-density buildings, poorly designed infrastructure, and overcrowded spaces underscore the need for integrated urban planning strategies to mitigate visual pollution. By considering the aesthetic and functional aspects of urban development, cities can reduce visual clutter and create more harmonious environments. Research suggests that implementing green spaces, cohesive architectural guidelines, and infrastructure that blends with the natural environment can significantly enhance the visual quality of urban areas (Carmona, 2021). These strategies not only improve the visual appeal of cities but also contribute to the well-being and mental health of their inhabitants.

Visual Pollution: Causes, Health Impacts, And Mitigation Strategies for Enhancing Environmental Aesthetics and Public Well-Being – A Review

2.2 Advertising

2.2.1 Billboards

Billboards have long been identified as significant contributors to visual pollution, particularly in urban areas. The presence of large, often brightly lit advertisements along highways and in city centers disrupts the natural and built environments, leading to visual clutter. This visual clutter can diminish the aesthetic quality of an area, making it less appealing to both residents and visitors. Research indicates that the overabundance of billboards can create a sense of disorientation and reduce the overall visual coherence of urban landscapes, negatively impacting the perception of a city's character (Salwa, 2022). Furthermore, billboards can obscure natural views and architectural features, further contributing to the degradation of the visual environment.

2.2.2 Digital Screens

The rise of digital screens as advertising mediums has exacerbated issues of visual pollution. Unlike traditional billboards, digital screens are dynamic, displaying changing images and videos that attract attention and contribute to visual overload. These screens are often placed in highly visible locations, such as city squares and shopping districts, where they can dominate the visual field and distract from the surrounding environment. Studies have shown that the constant motion and brightness of digital advertisements can lead to visual fatigue and decreased mental well-being, particularly in areas where such screens are densely concentrated (Jana & De, 2015). Additionally, the light pollution generated by digital screens can interfere with circadian rhythms and contribute to broader environmental concerns.

2.2.3 The Ubiquity of Advertisements and Its Consequences

Advertisements, whether on billboards, digital screens, or other mediums, have become ubiquitous in modern urban environments. This omnipresence of advertising content contributes to a phenomenon known as "ad creep," where public spaces are increasingly dominated by commercial messages, leaving little room for non-commercial visual elements (Crawford, 1992). The saturation of public spaces with advertisements can lead to a sense of visual bombardment, where individuals feel overwhelmed by the constant exposure to marketing messages. This can result in negative psychological effects, including stress and a decreased sense of autonomy over one's environment. Moreover, the prioritization of advertising space over public art and natural features can diminish the cultural and social value of urban areas, reducing their appeal and livability.

2.2.4 The Role of Regulations in Managing Visual Pollution from Advertisements

The management of visual pollution from billboards, digital screens, and advertisements is increasingly becoming a concern for urban planners and policymakers. In response to the negative impacts of visual clutter, some cities have implemented regulations that limit the size, placement, and brightness of advertisements in public spaces (Kelling & Coles, 1997). These regulations aim to strike a balance between commercial interests and the need to preserve the visual quality of urban environments. However, enforcement of such regulations can be challenging, particularly in rapidly growing cities where commercial pressures are high. Research suggests that effective management of visual pollution requires a comprehensive approach that includes public input, careful urban planning, and ongoing monitoring of advertising practices.

2.2.5 Future Trends and Challenges in Addressing Visual Pollution from Advertising

As technology continues to advance, the potential for visual pollution from advertising is likely to increase. Emerging trends such as augmented reality advertisements and interactive digital displays pose new challenges for managing visual clutter in urban areas. These technologies have the potential to further blur the lines between public and commercial spaces, making it even more difficult to preserve the visual integrity of cities (Froe, 2023). Addressing these challenges will require innovative solutions, such as the development of guidelines for the ethical use of new advertising technologies and the promotion of alternative, less intrusive forms of public communication.

2.3 Industrial and Technological Sources

2.3.1 The Impact of Power Lines on Visual Pollution

Power lines are a common feature of urban and rural landscapes, but their visual impact is often controversial. These structures can dominate the skyline, creating visual clutter and disrupting the natural aesthetics of an area. The visual intrusion of power lines is particularly noticeable in scenic or historic areas, where they can detract from the overall visual experience. Research indicates that the presence of overhead power lines can lower property values and negatively impact the perception of a community's attractiveness (Bond & Hopkins, 2000). The negative visual impact of power lines has led to calls for their burial underground, especially in areas of high scenic or cultural value, although this solution is often cost-prohibitive.

2.3.2 Visual Pollution from Factories and Industrial Installations

Factories and industrial installations are significant contributors to visual pollution, especially in urban and suburban areas. The large, often utilitarian structures of factories can clash with surrounding environments, creating eyesores that diminish the

Visual Pollution: Causes, Health Impacts, And Mitigation Strategies for Enhancing Environmental Aesthetics and Public Well-Being – A Review

aesthetic quality of the landscape. This is particularly problematic in areas where industrial zones are located near residential neighborhoods or natural landscapes. Studies have shown that the visual presence of factories can lead to decreased quality of life for nearby residents, including reduced mental well-being and dissatisfaction with the local environment (Lackey et al., 2021). The visual impact of industrial facilities is compounded by the presence of smoke stacks, storage tanks, and other large structures, which further contribute to visual clutter and environmental degradation.

2.4 Litter and Waste

2.4.1 Improperly Disposed Waste and Visual Pollution

Improperly disposed waste, including litter and illegal dumping, is a significant contributor to visual pollution in urban and rural areas alike. The presence of waste in public spaces not only detracts from the aesthetic quality of the environment but also signals neglect and lack of care, which can lead to further degradation. Studies have shown that areas with high levels of visible waste tend to experience a decline in community pride and social cohesion, as residents feel less connected to and responsible for their surroundings (Cialdini et al., 1990). Additionally, improperly disposed waste can attract pests and create health hazards, further compounding the negative impact on both the environment and public well-being.

2.4.2 The Impact of Graffiti on Visual Pollution

Graffiti, especially when unauthorized or placed in inappropriate locations, is a prominent source of visual pollution. While some view graffiti as a form of artistic expression, in many contexts it is associated with vandalism and urban decay. The presence of graffiti can negatively affect the perceived safety and cleanliness of an area, leading to reduced property values and increased perceptions of crime (Fieni, 2016). Furthermore, the proliferation of graffiti in public spaces often prompts costly and continuous efforts by municipalities to remove or cover the markings, diverting resources from other community needs.

2.4.3 Derelict Spaces and Their Contribution to Visual Pollution

Derelict spaces, including abandoned buildings, vacant lots, and neglected public areas, contribute significantly to visual pollution. These spaces often become overgrown, littered, and graffiti-covered, creating an environment that can feel unsafe and unwelcoming. The presence of derelict spaces is often linked to broader issues of economic decline, social disinvestment, and urban blight (Song, 2020). Such areas not only detract from the visual appeal of a community but can also serve as focal points for illegal activities, further exacerbating their negative impact on the local environment and residents' quality of life.

3. HEALTH IMPACTS OF VISUAL POLLUTION

3.1 Mental Health and Psychological Well-being:

3.1.1 Visual Pollution and Stress

Research has shown that visual pollution, such as cluttered environments filled with billboards, graffiti, and litter, can significantly contribute to stress levels in individuals. Studies have demonstrated that exposure to visually chaotic and unappealing environments triggers physiological stress responses, including elevated cortisol levels and increased heart rate (Ulrich, 1984). This response is believed to be rooted in the human preference for visually harmonious and natural environments, where the brain can process information more effortlessly, leading to a state of relaxation. In contrast, environments polluted with visual stimuli require more cognitive effort to process, contributing to a heightened state of stress and discomfort.

3.1.2 Visual Pollution and Anxiety

Visual pollution is also linked to increased levels of anxiety. Environments that are visually overwhelming or cluttered can create a sense of chaos and lack of control, which are key factors in the development of anxiety disorders. A study by Forgays and Forgays (1992) found that individuals living in visually polluted areas reported higher levels of anxiety compared to those in visually appealing environments (Forgays, & Forgays, 1992). The constant exposure to negative visual stimuli can cause chronic worry and agitation, as individuals struggle to navigate and make sense of their surroundings, leading to heightened anxiety levels.

3.1.3 Visual Pollution and Depression

There is growing evidence linking visual pollution to the development of depressive symptoms. Environments that are visually polluted with abandoned buildings, excessive signage, and litter can create a pervasive sense of bleakness and hopelessness. Kaplan's (1995) suggests that natural and aesthetically pleasing environments can help restore mental fatigue and reduce symptoms of depression (Kaplan's, 1995). Conversely, environments lacking these qualities, which are often characterized by visual pollution, may exacerbate feelings of sadness, fatigue, and hopelessness, contributing to the onset or worsening of depression.

Visual Pollution: Causes, Health Impacts, And Mitigation Strategies for Enhancing Environmental Aesthetics and Public Well-Being – A Review

3.1.4 Visual Pollution and Reduced Quality of Life

Visual pollution has a profound impact on individuals' perceived quality of life. Environments marred by unsightly elements such as graffiti, billboards, and litter can lead to feelings of dissatisfaction and discomfort, reducing overall well-being. Research by Sullivan and Chang (2011) indicates that people living in areas with high levels of visual pollution report lower levels of life satisfaction and community pride. The continuous exposure to unattractive and disordered surroundings can diminish the sense of safety, belonging, and overall happiness, thereby reducing the perceived quality of life.

3.2 Visual Fatigue and Eye Strain:

3.2.1 Visual Fatigue and Bright, Flashy Visuals

Constant exposure to bright and flashy visuals, such as those from digital screens, billboards, and neon signs, has been linked to visual fatigue. Studies have shown that the human eye is not well-adapted to prolonged exposure to intense and rapidly changing light sources, which can lead to eye strain and discomfort. The high contrast and flickering nature of such visuals force the eye muscles to work harder to maintain focus and process the images, leading to symptoms like eye soreness, headaches, and blurred vision (Blehm et al., 2005). This condition, often referred to as "digital eye strain" or "computer vision syndrome," is increasingly common in urban environments where such visuals are prevalent.

3.2.2 Overcrowded Visuals and Eye Health

Environments filled with overcrowded visuals, such as dense signage, advertisements, and cluttered urban landscapes, can also negatively impact eye health. The overwhelming amount of visual information can cause the eyes to become fatigued as they struggle to constantly shift focus and filter out unnecessary details. According to Rosenfield (2011), this continuous demand on the visual system can lead to visual fatigue, characterized by symptoms such as dry eyes, difficulty concentrating, and a reduction in visual acuity (Rosenfield, 2011). The cumulative effect of these symptoms over time can contribute to more serious eye conditions, especially in individuals who are already predisposed to eye strain.

3.2.3 Impact of Prolonged Visual Stimuli on Eye Health

Prolonged exposure to visual stimuli, particularly in urban settings filled with bright, flashy, and overcrowded visuals, can lead to a decrease in overall eye health. The repetitive strain on the eyes from processing excessive visual information can result in chronic visual fatigue. Zheng et al. (2021) highlighted that such environments could exacerbate existing conditions like myopia and astigmatism, as the eye muscles are under continuous stress to adjust to varying light levels and focus on multiple objects at different distances (Zheng et al., 2021). The persistent demand on the visual system can also reduce its ability to recover, leading to long-term issues such as persistent eye strain and reduced visual function.

3.2.4 Blue Light Exposure from Bright Visuals

Bright visuals, especially those emitting blue light, like digital screens and LED billboards, have been shown to contribute to visual fatigue and other eye-related problems. Blue light has a shorter wavelength and higher energy, which scatters more easily and can cause the eye to work harder to maintain focus, leading to strain (Lin et al., 2017). Additionally, excessive blue light exposure, particularly at night, can disrupt circadian rhythms and contribute to digital eye strain. This not only causes immediate discomfort but may also increase the risk of developing long-term eye issues, including macular degeneration.

3.3 Reduced Cognitive Function:

3.3.1 Impact of Visual Clutter on Concentration

Visual clutter, which refers to an excessive number of visual stimuli in an environment, can significantly impact concentration. Research indicates that environments overloaded with visual information can lead to cognitive overload, making it difficult for individuals to focus on specific tasks. Studies by Carver et al. (2008) demonstrate that visual clutter can reduce cognitive efficiency by increasing the amount of irrelevant information that the brain needs to process, thus impairing the ability to concentrate (Carver et al., 2008). The presence of too many competing visual elements can distract attention and reduce task performance, leading to decreased productivity and increased cognitive fatigue.

3.3.2 Visual Clutter and Memory

Visual clutter has also been shown to affect memory retention and recall. The presence of excessive and competing visual stimuli can overwhelm the cognitive system, leading to difficulties in encoding and retrieving information. According to a study by Baddeley and Hitch (1974), the working memory system can become overloaded when faced with high levels of visual clutter, which impairs the ability to remember and process information effectively (Baddeley & Hitch, 1974). This cognitive overload can result in reduced memory performance and difficulty in recalling information when needed.

Visual Pollution: Causes, Health Impacts, And Mitigation Strategies for Enhancing Environmental Aesthetics and Public Well-Being – A Review

3.3.3 Visual Clutter and Productivity

The impact of visual clutter on productivity is well-documented in organizational and work environments. Environments characterized by excessive visual stimuli can reduce overall productivity by causing frequent distractions and impairing task performance. A study by Evans (2000) found that individuals working in cluttered environments experience reduced productivity due to the increased cognitive load required to filter out irrelevant visual information (Evans, 2000). This clutter-induced cognitive burden can lead to slower work performance, higher error rates, and increased stress, ultimately affecting overall job efficiency and satisfaction.

3.3.4 Visual Clutter and Cognitive Load

Visual clutter increases cognitive load, which can negatively impact various cognitive processes such as problem-solving and decision-making. Research by Sweller (1988) on cognitive load theory suggests that environments with high levels of visual clutter can overwhelm the cognitive system, making it harder to perform complex tasks that require mental effort (Sweller, 1988). The cognitive load imposed by visual clutter can reduce the efficiency of problem-solving and decision-making processes, leading to lower performance and increased mental fatigue.

3.4 Impact on Children's Development:

3.4.1 Impact of Visual Pollution on Children's Learning

Visual pollution, including excessive and distracting visual stimuli such as bright advertisements and poorly designed environments, can negatively affect children's learning. A study by Banire et al. (2020) found that environments with high visual clutter can lead to decreased attention and concentration in children, impacting their ability to engage with educational material (Banire et al., 2020). The presence of competing visual stimuli can distract students from their tasks and hinder their cognitive processing, thereby affecting academic performance and learning outcomes.

3.4.2 Visual Pollution and Developmental Milestones

Exposure to visual pollution can influence developmental milestones in children, particularly in relation to sensory and cognitive development. Research indicates that children exposed to environments with high levels of visual clutter may experience delays in visual and perceptual development. The study suggests that constant exposure to overwhelming visual stimuli can interfere with the development of visual processing skills, which are critical for various cognitive functions and developmental milestones (Gifford, 2014).

3.4.3 Behavioral Problems Linked to Visual Pollution

Children exposed to visual pollution, such as chaotic and cluttered environments, may exhibit behavioral problems. A study found that children in visually polluted environments are more likely to exhibit signs of stress and behavioral issues, including aggression and impulsivity. The research highlights that the constant bombardment of visual stimuli can lead to increased anxiety and frustration, which in turn affects behavior and emotional regulation in children (Evans & Wachs, 2010; Dul & Ceylan, 2011).

3.4.4 Visual Pollution and Attention Span

The presence of visual pollution can reduce children's attention span and focus. Research demonstrated that children exposed to environments with excessive visual stimuli had shorter attention spans and were more prone to distraction. The study emphasizes that visual clutter can overwhelm children's cognitive resources, leading to difficulties in maintaining attention and completing tasks effectively (Fisher & Kloos, 2016).

3.5 General Well-being:

3.5.1 Correlation Between Visual Pollution and General Well-Being

Several studies have highlighted the negative impact of visual pollution on general well-being. Research by Kaplan and Kaplan (1989) suggests that visually polluted environments, characterized by excessive and disorganized visual stimuli, can lead to reduced general well-being. Their study indicates that exposure to such environments can cause stress and discomfort, which negatively affects overall mental health and life satisfaction. The authors argue that a cluttered visual environment can lead to cognitive overload and emotional distress, thus reducing overall quality of life (Kaplan & Kaplan, 1989).

3.5.2 Visual Pollution and Life Satisfaction

The impact of visual pollution on life satisfaction has been examined in various studies. For instance, a study by Stokols and Shumaker (1981) found that individuals living in visually polluted environments reported lower levels of life satisfaction compared to those in less cluttered settings. The study emphasizes that the visual quality of one's environment can significantly influence personal satisfaction and perceived quality of life (Stokols, 1981). The presence of unsightly or overwhelming visual elements can detract from one's sense of comfort and contentment.

Visual Pollution: Causes, Health Impacts, And Mitigation Strategies for Enhancing Environmental Aesthetics and Public Well-Being – A Review

3.5.3 Visual Pollution and Emotional Well-Being

Visual pollution has been linked to adverse effects on emotional well-being. Research by Ulrich et al. (1991) indicates that environments with high levels of visual clutter can lead to increased feelings of stress and anxiety, which in turn affect emotional health. Their study shows that individuals exposed to visually cluttered environments experience more negative emotions and reduced emotional well-being compared to those in visually calming settings. This research highlights the importance of visual aesthetics in maintaining emotional balance and well-being (Ulrich et al., 1991).

3.5.4 Long-Term Impact of Visual Pollution on Quality of Life

Long-term exposure to visually polluted environments can have a profound impact on quality of life. A study by Berto (2005) examined how persistent exposure to visually cluttered or unpleasant environments can lead to long-term reductions in overall life satisfaction and well-being. The research found that individuals living in such environments are more likely to experience chronic stress and diminished quality of life. The study underscores the importance of considering visual quality in urban planning and environmental design to enhance overall life satisfaction.

4. VISUAL POLLUTION IN DIFFERENT CONTEXTS

4.1 Urban vs. Rural Environments:

4.1.1 Impact of Visual Pollution in Urban Settings

Urban environments are often characterized by high levels of visual pollution due to dense development, extensive signage, and high traffic volumes. Research by Cackowski and Nasar (2003) highlights that urban areas face significant challenges related to visual pollution, including excessive billboards, neon signs, and poorly designed public spaces. These elements contribute to visual clutter and can negatively impact residents' mental health, stress levels, and overall quality of life. The study emphasizes that the constant exposure to visually overwhelming stimuli in urban settings can lead to higher levels of cognitive and emotional stress (Cackowski & Nasar, 2003).

4.1.2 Challenges of Visual Pollution in Rural Settings

In contrast, rural settings often face different challenges related to visual pollution. Studies, such as those by Zube et al. (1987), reveal that while rural areas might experience less intensity of visual clutter compared to urban settings, they still encounter issues related to visual pollution. Rural visual pollution often involves intrusive elements such as large industrial installations or unsightly agricultural structures. These elements can disrupt the natural landscape and affect residents' perception of their environment, leading to dissatisfaction and decreased quality of life (Zube et al., 1987).

4.1.3 Urban vs. Rural Visual Pollution: Unique Challenges

The comparison of urban and rural visual pollution reveals distinct challenges in each context. A study by Arriaza et al. (2004) demonstrates that urban visual pollution typically involves high-density, man-made elements such as advertisements and high-rise buildings, which create a visually overwhelming environment. In contrast, rural visual pollution may be less frequent but can be just as disruptive, often involving large-scale industrial or infrastructural elements that mar the natural landscape. Each setting requires tailored approaches to mitigate visual pollution and improve residents' quality of life (Arriaza et al., 2004).

4.1.4 Impacts on Well-Being in Urban vs. Rural Settings

The impact of visual pollution on well-being varies between urban and rural settings. According to a study by Scopelliti and Giuliani (2004), urban environments with high visual pollution often led to increased stress and lower life satisfaction due to the constant exposure to disorganized and intrusive visual elements. Conversely, in rural settings, visual pollution may not be as constant but can significantly affect residents when it occurs, particularly when it disrupts the perceived natural beauty of the landscape. Both settings demonstrate that visual pollution negatively impacts well-being but through different mechanisms and intensities (Scopelliti & Giuliani, 2004).

4.2 Developed vs. Developing Countries:

4.2.1 Manifestations of Visual Pollution in Developed Countries

In developed countries, visual pollution often manifests through extensive urban development, high-density signage, and intrusive advertising. Research by Guite et al. (2006) highlights that developed nations frequently face issues such as excessive billboard advertisements, neon lights, and architectural designs that contribute to visual clutter. These elements can lead to aesthetic degradation of the urban environment and affect residents' mental well-being. The study underscores that in developed countries, the focus of visual pollution is often on the impact of commercial and infrastructural elements on the urban landscape (Guite et al., 2006).

Visual Pollution: Causes, Health Impacts, And Mitigation Strategies for Enhancing Environmental Aesthetics and Public Well-Being – A Review

4.2.2 Manifestations of Visual Pollution in Developing Countries

In developing countries, visual pollution is often characterized by a combination of rapid urbanization, informal settlements, and inadequate waste management. A study by Andjarsari et al. (2022) shows that developing countries face unique challenges such as unregulated billboards, poorly planned urban infrastructure, and unmanaged waste disposal, which contribute to visual clutter. These factors can result in significant aesthetic and health impacts, as the chaotic and unplanned development can lead to a lower quality of living conditions and increased exposure to stressors (Andjarsari et al., 2022).

4.2.3 Health Impacts in Developed Countries

In developed countries, the health impacts of visual pollution are linked to psychological stress and decreased quality of life. The residents in visually polluted urban environments may experience higher levels of stress and dissatisfaction due to constant exposure to excessive and disorganized visual stimuli. This can lead to mental health issues such as anxiety and depression. The research emphasizes that the aesthetic quality of urban environments plays a crucial role in maintaining mental well-being in developed nations (Sugiyama et al., 2008).

4.2.4 Health Impacts in Developing Countries

In developing countries, the health impacts of visual pollution are often compounded by broader socio-economic issues. Research by Danda and colleagues (2016) indicates that visual pollution in these regions can exacerbate health problems related to poor sanitation and inadequate infrastructure. The chaotic visual environment can contribute to stress, anxiety, and lower overall quality of life. Additionally, the lack of effective urban planning and waste management can further degrade the living conditions, impacting both physical and mental health.

5. VULNERABLE POPULATIONS

5.1 Children and Adolescents:

5.1.1 Impact of Visual Pollution on Children's Educational Environments

Visual pollution in educational settings, such as overcrowded classrooms and excessive signage, can significantly affect younger populations. A study by Zazzi and Faragher (2018) found that excessive visual clutter in classrooms can impair students' ability to concentrate and process information. The study highlights that classrooms with distracting visual elements may lead to decreased academic performance and increased stress levels among students (Zazzi & Faragher, 2018).

5.1.2 Distraction and Cognitive Load

Research by Cohen et al. (2013) suggests that visual pollution can increase cognitive load and distraction in educational environments. The study discusses how visual distractions, such as poorly designed learning materials or excessive decorations, can reduce students' attention span and memory retention. This increased cognitive load can hinder students' learning processes and overall academic achievement (Cohen et al., 2013).

5.1.3 Impact on Behavioral and Emotional Well-Being

Visual pollution in educational settings can also affect children's behavioral and emotional well-being. According to research by Rodrigues and Pandeirada (2018), children exposed to visually polluted environments may experience increased levels of anxiety and behavioral issues. The study highlights that an environment with excessive visual stimuli can contribute to feelings of overstimulation and emotional distress among students (Rodrigues & Pandeirada, 2018).

5.1.4 Long-Term Developmental Effects

Long-term exposure to visual pollution in educational settings can have lasting effects on children's development. A longitudinal study by Black et al. (2019) shows that persistent exposure to visually cluttered environments can impact children's cognitive development and academic performance over time. The research emphasizes the importance of creating visually supportive educational environments to foster better long-term outcomes for students (Black et al., 2019).

5.2 Elderly:

5.2.1 Increased Sensitivity of the Elderly to Visual Pollution

Elderly individuals are particularly sensitive to visual pollution due to age-related changes in visual perception and cognitive function. A study by Mangione et al. (1999) highlights that older adults often experience diminished visual acuity and contrast sensitivity, making them more vulnerable to the negative effects of visual clutter. The research indicates that excessive visual stimuli can exacerbate visual discomfort and cognitive overload in this population (Mangione et al., 1999).

5.2.2 Mental Health Effects

Visual pollution can also impact the mental health of the elderly. According to research by Bai and Jin (2023), exposure to visually cluttered environments is associated with increased levels of stress, anxiety, and depression among older adults. The study points

Visual Pollution: Causes, Health Impacts, And Mitigation Strategies for Enhancing Environmental Aesthetics and Public Well-Being – A Review

out that elderly individuals may have a reduced ability to cope with visual overload, leading to heightened emotional distress and diminished quality of life (Bai & Jin, 2023).

5.2.3 Physical Health Impacts

The physical health of elderly individuals can also be affected by visual pollution. Research by Zazzi and Faragher (2018) shows that visually cluttered environments can lead to increased risks of falls and accidents in older adults. The study suggests that visual distractions can impair spatial orientation and depth perception, contributing to a higher incidence of physical injuries (Zazzi & Faragher, 2018).

5.2.4 Cognitive Function and Visual Pollution

Cognitive function in the elderly can be adversely affected by visual pollution. A study by Schilling and colleagues (2019) finds that older adults exposed to environments with excessive visual stimuli may experience accelerated cognitive decline. The research indicates that visual clutter can interfere with cognitive processes such as attention and memory, which are already vulnerable in aging populations.

5.3 Socioeconomically Disadvantaged Groups:

5.3.1 Visual Pollution and Lower-Income Communities

Visual pollution disproportionately affects lower-income communities due to higher exposure to visually cluttered environments. A study by Lovell et al. (2018) found that lower-income neighborhoods often face increased levels of visual pollution due to factors such as poor urban planning and inadequate infrastructure. These areas are more likely to have neglected or dilapidated spaces that contribute to a higher visual clutter, impacting residents' quality of life (Lovell et al., 2018).

5.3.2 Health Disparities Linked to Visual Pollution

Visual pollution in lower-income communities exacerbates existing health disparities. Research by Williams et al. (2019) highlights that residents in these areas face greater health challenges due to the combined effects of visual pollution and socio-economic stressors. The study emphasizes that visual pollution can aggravate stress and mental health issues, further widening health inequalities between higher and lower-income populations.

5.3.3 Socio-Economic Factors and Exposure to Visual Pollution

Lower-income communities are more likely to be situated near sources of visual pollution, such as industrial areas and busy roadways (Bullard, 2018). A study by Maantay et al. (2016) discusses how socio-economic factors contribute to higher exposure levels in these communities. The research shows that lower-income areas often lack green spaces and are characterized by high-density development, which increases residents' exposure to visual clutter (Maantay et al., 2016).

5.3.4 Impact on Quality of Life and Well-Being

The impact of visual pollution on quality of life and well-being is more pronounced in lower-income communities. According to research by Mitchell and Popham (2008), the visual environment in these communities can lead to diminished psychological well-being and increased stress levels. The study underscores that the cumulative effects of visual pollution and socio-economic disadvantages can significantly reduce the overall quality of life for residents (Mitchell & Popham, 2008).

6. MITIGATION STRATEGIES

6.1 Urban Planning and Design:

6.1.1 Role of Urban Planning in Reducing Visual Pollution

Green Spaces: Incorporating green spaces into urban planning is a key strategy for mitigating visual pollution. Research by Kothencz et al. (2017) demonstrates that urban parks and green belts can provide visual relief and enhance the aesthetic appeal of cities. Green spaces not only reduce visual clutter but also contribute to improved mental health and well-being by offering residents a visually pleasant environment (Kothencz et al., 2017).

Zoning Regulations: Effective zoning regulations play a significant role in controlling visual pollution by guiding the placement and design of buildings and infrastructure. A study by Fong and Kothari (2015) emphasizes that comprehensive zoning laws can prevent incompatible land uses and reduce the impact of visually disruptive elements, such as billboards and high-density developments.

Aesthetic Guidelines: Implementing aesthetic guidelines in urban design can effectively reduce visual pollution. According to a study by Rapoport (2017), aesthetic guidelines that emphasize harmonious design and architectural coherence can enhance the visual quality of urban environments. These guidelines help ensure that new developments contribute positively to the overall visual landscape.

Visual Pollution: Causes, Health Impacts, And Mitigation Strategies for Enhancing Environmental Aesthetics and Public Well-Being – A Review

6.2 Regulatory Measures:

6.2.1 Effectiveness of Regulations on Outdoor Advertising

Outdoor Advertising Regulations: Regulations on outdoor advertising are crucial for mitigating visual pollution. Studies show that strict guidelines on billboard sizes, placement, and lighting can significantly reduce visual clutter. A study by Wakil et al. (2019) evaluated the effectiveness of billboard regulations in several major cities and found that cities with stringent controls reported improved visual aesthetics and reduced public complaints about visual pollution (Wakil et al., 2019).

6.2.2 Effectiveness of Industrial Design Regulations

Industrial Design Regulations: Regulations on industrial design can play a significant role in reducing visual pollution by controlling the appearance and location of industrial facilities. According to research by Sumartono (2009), effective industrial design regulations help ensure that industrial buildings and equipment are aesthetically integrated into their surroundings, reducing their visual impact on nearby residential and commercial areas (Sumartono, 2009).

6.2.3 Effectiveness of Waste Management Regulations

Waste Management Regulations: Proper waste management regulations are essential for mitigating visual pollution from litter and illegal dumping. A study by Ahmed et al. (2019) found that cities with comprehensive waste management programs, including regular waste collection and strict penalties for illegal dumping, experienced lower levels of visible waste and improved urban aesthetics (Ahmed et al., 2019).

CONCLUSIONS

The article concludes that visual pollution significantly impacts both the environment and human health, with negative effects more pronounced in vulnerable populations such as lower-income communities, children, and the elderly. The study highlights that visual pollution leads to stress, anxiety, and reduced quality of life due to cluttered, unattractive environments. It also emphasizes the disparities in exposure, where lower-income areas face higher levels of visual pollution due to inadequate infrastructure and urban planning.

Mitigation strategies discussed in the article include incorporating green spaces, implementing strict zoning regulations, enforcing outdoor advertising controls, and improving waste management practices. The conclusion stresses the importance of integrated urban planning and regulatory measures to reduce visual pollution and enhance the aesthetic quality of living spaces, thereby improving overall well-being.

REFERENCES

- 1) Ahmed, N., Islam, M. N., Tuba, A. S., Mahdy, M. R. C., & Sujauddin, M. (2019). Solving visual pollution with deep learning: A new nexus in environmental management. *Journal of environmental management*, 248, 109253. <https://doi.org/10.1016/j.jenvman.2019.07.024>
- 2) Andjarsari, S., Subadyo, A. T., & Bonifacius, N. (2022, March). Safe construction and visual pollution of billboards along Main Street. In *IOP conference series: earth and environmental science* (Vol. 999, No. 1, p. 012015). IOP Publishing. <https://doi.org/10.1088/1755-1315/999/1/012015>
- 3) Angel, S. (2012). *Planet of cities* (p. 360). Cambridge, MA: Lincoln Institute of Land Policy. https://wagner.nyu.edu/files/faculty/publications/PlanetofCities_Shloomo_Web_Chapter.pdf
- 4) Appleyard, D. (1979). The environment as a social symbol: Within a theory of environmental action and perception. *Journal of the American Planning Association*, 45(2), 143-153. <https://doi.org/10.1080/01944367908976952>
- 5) Arriaza, M., Cañas-Ortega, J. F., Cañas-Madueño, J. A., & Ruiz-Aviles, P. (2004). Assessing the visual quality of rural landscapes. *Landscape and urban planning*, 69(1), 115-125. <https://doi.org/10.1016/j.landurbplan.2003.10.029>
- 6) Azumah, D. M. Y., Hinson, R. E., Nukpezah, D., & Yiran, G. A. B. (2021). Visual pollution through excessive outdoor advertisements. *Marketing Communications in Emerging Economies, Volume I: Foundational and Contemporary Issues*, 193-228. https://doi.org/10.1007/978-3-030-81329-1_8
- 7) Baddeley, A. (2020). Working memory. In *Memory* (pp. 71-111). Routledge. <https://doi.org/10.4324/9780429449642>
- 8) Bai, Y., & Jin, H. (2023). Effects of visual, thermal, and acoustic comfort on the psychological restoration of the older people in a severe cold city. *Building and Environment*, 239, 110402. <https://doi.org/10.1016/j.buildenv.2023.110402>
- 9) Banire, B., Al-Thani, D., Qaraq, M., Khowaja, K., & Mansoor, B. (2020). The effects of visual stimuli on attention in children with autism spectrum disorder: an eye-tracking study. *IEEE Access*, 8, 225663-225674. <https://doi.org/10.1109/ACCESS.2020.3045042>

Visual Pollution: Causes, Health Impacts, And Mitigation Strategies for Enhancing Environmental Aesthetics and Public Well-Being – A Review

- 10) Berleant, A. (1997). *Living in the landscape: Toward an aesthetics of environment*. University press of Kansas. <https://doi.org/10.1177/002216789503500305>
- 11) Berto, R. (2005). Exposure to restorative environments helps restore attentional capacity. *Journal of environmental psychology*, 25(3), 249-259. <https://doi.org/10.1016/j.jenvp.2005.07.001>
- 12) Black, S. A., McConnell, E. L., McKerr, L., McClelland, J. F., Little, J. A., Dillenburger, K., ... & Saunders, K. J. (2019). In-school eyecare in special education settings has measurable benefits for children's vision and behaviour. *PLoS One*, 14(8), e0220480. <https://doi.org/10.1371/journal.pone.0220480>
- 13) Blehm, C., Vishnu, S., Khattak, A., Mitra, S., & Yee, R. W. (2005). Computer vision syndrome: a review. *Survey of ophthalmology*, 50(3), 253-262. <https://doi.org/10.1016/j.survophthal.2005.02.008>
- 14) Bond, S., & Hopkins, J. (2000). The impact of transmission lines on residential property values: results of a case study in a suburb of Wellington, NZ. *Pacific Rim property research journal*, 6(2), 52-60. <https://doi.org/10.1080/14445921.2000.11104090>
- 15) Bordenave, G., & Lung, Y. (1996). New spatial configurations in the European automobile industry. *European Urban and Regional Studies*, 3(4), 305-321. <https://doi.org/10.1177/096977649600300403>
- 16) Bullard, R. D. (2018). *Dumping in Dixie: Race, class, and environmental quality*. Routledge. <https://doi.org/10.4324/9780429495274>
- 17) Cackowski, J. M., & Nasar, J. L. (2003). The restorative effects of roadside vegetation: Implications for automobile driver anger and frustration. *Environment and behavior*, 35(6), 736-751. <https://doi.org/10.1177/0013916503256267>
- 18) Carmona, M. (2021). *Public places urban spaces: The dimensions of urban design*. Routledge. <https://doi.org/10.4324/9781315158457>
- 19) Carver, C. S., & Scheier, M. F. (2001). *On the self-regulation of behavior*. cambridge university press. <https://doi.org/10.1017/CBO9780511801125>
- 20) Cialdini, R. B., Reno, R. R., & Kallgren, C. A. (1990). A focus theory of normative conduct: Recycling the concept of norms to reduce littering in public places. *Journal of personality and social psychology*, 58(6), 1015.
- 21) Cohen, S., Evans, G. W., Stokols, D., & Krantz, D. S. (2013). *Behavior, health, and environmental stress*. Springer Science & Business Media. <https://doi.org/10.1007/978-1-4757-9380-2>
- 22) Crawford, M. (1992). *The world in a shopping mall*. na.
- 23) Dul, J., & Ceylan, C. (2011). Work environments for employee creativity. *Ergonomics*, 54(1), 12-20. <https://doi.org/10.1080/00140139.2010.542833>
- 24) Evans, G. W. (2003). The built environment and mental health. *Journal of urban health*, 80, 536-555. <https://doi.org/10.1093/jurban/jtg063>
- 25) Evans, G. W. (Ed.). (1984). *Environmental stress*. CUP Archive.
- 26) Evans, G. W., & Wachs, T. D. (2010). Chaos and its influence on children's development. Washington, DC: American Psychological Association, 6(2-3), 66-80. <https://psycnet.apa.org/fulltext/2009-08920-000-FRM.pdf>
- 27) Fieni, D. (2016). Graffiti and street art in Paris. In *Routledge Handbook of Graffiti and Street Art* (pp. 288-300). Routledge. <https://doi.org/10.4324/9781315761664>
- 28) Fisher, A., & Kloos, H. (2016). Development of selective sustained attention: The role of executive functions. <https://doi.org/10.1037/14797-010>
- 29) Forgays, D. G., & Forgays, D. K. (1992). Creativity enhancement through flotation isolation. *Journal of Environmental Psychology*, 12(4), 329-335. [https://doi.org/10.1016/S0272-4944\(05\)80081-7](https://doi.org/10.1016/S0272-4944(05)80081-7)
- 30) Froe, M. D. (2023). *Guidelines for augmented reality advertising: A consumer ethical impact assessment tool* (Master's thesis). <https://studenttheses.uu.nl/handle/20.500.12932/44572>
- 31) Gao, H., Bakar, S. A., Maulan, S., Yusof, M. J. M., Mundher, R., Guo, Y., & Chen, B. (2024). A Systematic Literature Review and Analysis of Visual Pollution. *Land*, 13(7), 994. <https://doi.org/10.3390/land13070994>
- 32) Gifford, R. (2014). Environmental psychology matters. *Annual review of psychology*, 65(1), 541-579. <https://doi.org/10.1146/annurev-psych-010213-115048>
- 33) Guite, H. F., Clark, C., & Ackrill, G. (2006). The impact of the physical and urban environment on mental well-being. *Public health*, 120(12), 1117-1126. <https://doi.org/10.1016/j.puhe.2006.10.005>
- 34) Habitat, U. N. (2013). *State of the world's cities 2012/2013: Prosperity of cities*. Routledge. <https://doi.org/10.4324/9780203756171>

Visual Pollution: Causes, Health Impacts, And Mitigation Strategies for Enhancing Environmental Aesthetics and Public Well-Being – A Review

- 35) Ho, G., Scialfa, C. T., Caird, J. K., & Graw, T. (2001). Visual search for traffic signs: The effects of clutter, luminance, and aging. *Human factors*, 43(2), 194-207. <https://doi.org/10.1518/001872001775900922>
- 36) Hull, R. B., & Bishop, I. D. (1988). Scenic impacts of electricity transmission towers: The influence of landscape type and observer distance. *Journal of Environmental Management*, 27(1), 99-108.
- 37) Jana, M. K., & De, T. (2015). Visual pollution can have a deep degrading effect on urban and suburban community: a study in few places of Bengal, India, with special reference to unorganized billboards. *European Scientific Journal*. <https://core.ac.uk/download/pdf/236417101.pdf>
- 38) Kaplan, R., & Kaplan, S. (1989). *The experience of nature: A psychological perspective*. Cambridge university press. <https://doi.org/10.1017/CBO9780511623286>
- 39) Kaplan, S. (1995). The restorative benefits of nature: Toward an integrative framework. *Journal of environmental psychology*, 15(3), 169-182. [https://doi.org/10.1016/0272-4944\(95\)90001-2](https://doi.org/10.1016/0272-4944(95)90001-2)
- 40) Kavaratzis, M. (2005). Place branding: A review of trends and conceptual models. *The marketing review*, 5(4), 329-342. <https://doi.org/10.1362/146934705775186854>
- 41) Kelling, G. L., & Coles, C. M. (1997). *Fixing broken windows: Restoring order and reducing crime in our communities*. Simon and Schuster.
- 42) Kjellstrom, T., & Mercado, S. (2008). Towards action on social determinants for health equity in urban settings. *Environment and Urbanization*, 20(2), 551-574. <https://doi.org/10.1177/0956247808096128>
- 43) Kothencz, G., Kolcsár, R., Cabrera-Barona, P., & Szilassi, P. (2017). Urban green space perception and its contribution to well-being. *International journal of environmental research and public health*, 14(7), 766. <https://doi.org/10.3390/ijerph14070766>
- 44) Lackey, N. Q., Tysor, D. A., McNay, G. D., Joyner, L., Baker, K. H., & Hodge, C. (2021). Mental health benefits of nature-based recreation: a systematic review. *Annals of Leisure Research*, 24(3), 379-393. <https://doi.org/10.1080/11745398.2019.1655459>
- 45) Lin, J. B., Gerratt, B. W., Bassi, C. J., & Apte, R. S. (2017). Short-wavelength light-blocking eyeglasses attenuate symptoms of eye fatigue. *Investigative ophthalmology & visual science*, 58(1), 442-447. <https://doi.org/10.1167/iovs.16-20663>
- 46) Lovell, R., Depledge, M., & Maxwell, S. (2018). Health and the natural environment: A review of evidence, policy, practice and opportunities for the future.
- 47) Lynch, K. (1960). *The image of the city*/Lynch Kevin.
- 48) Maantay, J., Chakraborty, J., & Brender, J. (2010, March). Proximity to environmental hazards: Environmental justice and adverse health outcomes. In *Strengthening environmental justice research and decision making: a symposium on the science of disproportionate environmental health impacts* (pp. 17-19). <https://archive.epa.gov/ncer/ej/web/pdf/brender.pdf>
- 49) Mangione, C. M., Gutierrez, P. R., Lowe, G., Orav, E. J., & Seddon, J. M. (1999). Influence of age-related maculopathy on visual functioning and health-related quality of life. *American journal of ophthalmology*, 128(1), 45-53. [https://doi.org/10.1016/S0002-9394\(99\)00169-5](https://doi.org/10.1016/S0002-9394(99)00169-5)
- 50) McCay, L., Bremer, I., Endale, T., Jannati, M., & Yi, J. (2019). Urban design and mental health. *Urban mental health*, 32, 1-3.
- 51) Mitchell, R., & Popham, F. (2008). Effect of exposure to natural environment on health inequalities: an observational population study. *The lancet*, 372(9650), 1655-1660. [https://doi.org/10.1016/S0140-6736\(08\)61689-X](https://doi.org/10.1016/S0140-6736(08)61689-X)
- 52) Nasar, J. L. (1990). The evaluative image of the city. *Journal of the American Planning Association*, 56(1), 41-53. <https://doi.org/10.1080/01944369008975742>
- 53) Nasar, J. L. (1994). Urban design aesthetics: The evaluative qualities of building exteriors. *Environment and behavior*, 26(3), 377-401. <https://doi.org/10.1177/001391659402600305>
- 54) Nasar, J. L. (Ed.). (1992). *Environmental aesthetics: Theory, research, and application*. Cambridge University Press. <https://doi.org/10.1017/CBO9780511571213>
- 55) Nessim, A. A. (2020). Visual pollution: an approach to reduce the environmental impact of light pollution in Egypt. In *Architecture and Urbanism: A Smart Outlook: Proceedings of the 3rd International Conference on Architecture and Urban Planning, Cairo, Egypt* (pp. 469-481). Springer International Publishing. https://doi.org/10.1007/978-3-030-52584-2_33
- 56) Pacione, M. (2009). *Urban Geography: A Global Perspective*.
- 57) Palmer, J. F. (2004). Using spatial metrics to predict scenic perception in a changing landscape: Dennis, Massachusetts. *Landscape and urban Planning*, 69(2-3), 201-218. <https://doi.org/10.1016/j.landurbplan.2003.08.010>
- 58) Porteous, J. D. (2013). *Environmental aesthetics: Ideas, politics and planning*. routledge.

Visual Pollution: Causes, Health Impacts, And Mitigation Strategies for Enhancing Environmental Aesthetics and Public Well-Being – A Review

<https://doi.org/10.4324/9780203437322>

- 59) Punter, J. (2007). Developing urban design as public policy: Best practice principles for design review and development management. *Journal of Urban design*, 12(2), 167-202. <https://doi.org/10.1080/13574800701306195>
- 60) Punter, J. (2017). Aesthetics in planning. *Values and planning*, 38-67. <https://doi.org/10.4324/9781315235141>
- 61) Purcell, T., Peron, E., & Berto, R. (2001). Why do preferences differ between scene types?. *Environment and behavior*, 33(1), 93-106. <https://doi.org/10.1177/00139160121972882>
- 62) Rathje, W. L., & Murphy, C. (2001). *Rubbish!: the archaeology of garbage*. University of Arizona Press.
- 63) Rodrigues, P. F., & Pandeirada, J. N. (2018). When visual stimulation of the surrounding environment affects children's cognitive performance. *Journal of experimental child psychology*, 176, 140-149. <https://doi.org/10.1016/j.jecp.2018.07.014>
- 64) Rosenfield, M. (2011). Computer vision syndrome: a review of ocular causes and potential treatments. *Ophthalmic and Physiological Optics*, 31(5), 502-515. <https://doi.org/10.1111/j.1475-1313.2011.00834.x>
- 65) Sagvan Ageed, Najmadin E. Hassan and Salih F. Ismael (2019). Repercussion of Visual Pollution and its Effects on Some People in Duhok Governorate/Iraq. *International Journal of Current Advanced Research*, 08(01), pp. 16918-16921. <http://dx.doi.org/10.24327/ijcar>
- 66) Salwa, M. (2022). Landscape Aesthetics and Politics. In *Aesthetic Perspectives on Culture, Politics, and Landscape: Appearances of the Political* (pp. 83-100). Cham: Springer International Publishing. https://doi.org/10.1007/978-3-030-77830-9_7
- 67) Schultz, P. W., Bator, R. J., Large, L. B., Bruni, C. M., & Tabanico, J. J. (2013). Littering in context: Personal and environmental predictors of littering behavior. *Environment and Behavior*, 45(1), 35-59. <https://doi.org/10.1177/0013916511412179>
- 68) Scopelliti, M., & Giuliani, M. V. (2004). Choosing restorative environments across the lifespan: A matter of place experience. *Journal of environmental psychology*, 24(4), 423-437. <https://doi.org/10.1016/j.jenvp.2004.11.002>
- 69) Shanmugathas, D. M. (2018). Billboard advertisement strategies. *International Journal of Application or Innovation in Engineering & Management (IJAIEM)*, 7(4). <https://ssrn.com/abstract=3208648>
- 70) Song, X., Wen, M., Shen, Y., Feng, Q., Xiang, J., Zhang, W., ... & Wu, Z. (2020). Urban vacant land in growing urbanization: An international review. *Journal of Geographical Sciences*, 30, 669-687. <https://doi.org/10.1007/s11442-020-1749-0>
- 71) Stamps, A. E. (2013). *Psychology and the aesthetics of the built environment*. Springer Science & Business Media. <https://doi.org/10.1007/978-1-4615-4223-4>
- 72) Stokols, D. (1981). People in places: A transactional view of settings. *Cognition, Social Behavior, and the Environment/Lawrence Erlbaum*. <https://doi.org/10.4324/9781315805767-10>
- 73) Sugiyama, T., Leslie, E., Giles-Corti, B., & Owen, N. (2008). Associations of neighbourhood greenness with physical and mental health: do walking, social coherence and local social interaction explain the relationships?. *Journal of Epidemiology & Community Health*, 62(5), e9-e9. <https://doi.org/10.1136/jech.2007.064287>
- 74) Sullivan, W. C., & Chang, C. Y. (2011). Mental health and the built environment. *Making healthy places: Designing and building for health, well-being, and sustainability*, 106-116. https://doi.org/10.5822/978-1-61091-036-1_7
- 75) Sumartono, S. (2009). Visual pollution in the context of conflicting design requirements. *Jurnal Dimensi Seni Rupa dan Desain*, 6(2), 157-172. <https://doi.org/10.25105/dim.v6i2.1140>
- 76) Sumper, A., Boix-Aragones, O., Rull-Duran, J., Amat-Algaba, J., & Wagner, J. (2021). Assessment of the visual impact of existing high-voltage lines in Urban Areas. *Electricity*, 2(3), 285-299. <https://doi.org/10.3390/electricity2030017>
- 77) Swanwick, C. (2009). Society's attitudes to and preferences for land and landscape. *Land use policy*, 26, S62-S75. <https://doi.org/10.1016/j.landusepol.2009.08.025>
- 78) Sweller, J. (1988). Cognitive load during problem solving: Effects on learning. *Cognitive science*, 12(2), 257-285. [https://doi.org/10.1016/0364-0213\(88\)90023-7](https://doi.org/10.1016/0364-0213(88)90023-7)
- 79) Ulrich, R. S. (1984). View through a window may influence recovery from surgery. *science*, 224(4647), 420-421. <https://doi.org/10.1126/science.6143402>
- 80) Ulrich, R. S., Simons, R. F., Losito, B. D., Fiorito, E., Miles, M. A., & Zelson, M. (1991). Stress recovery during exposure to natural and urban environments. *Journal of environmental psychology*, 11(3), 201-230. [https://doi.org/10.1016/S0272-4944\(05\)80184-7](https://doi.org/10.1016/S0272-4944(05)80184-7)
- 81) Wakil, K., Naeem, M. A., Anjum, G. A., Waheed, A., Thaheem, M. J., Hussnain, M. Q. U., & Nawaz, R. (2019). A hybrid tool for visual pollution Assessment in urban environments. *Sustainability*, 11(8), 2211. <https://doi.org/10.3390/su11082211>

Visual Pollution: Causes, Health Impacts, And Mitigation Strategies for Enhancing Environmental Aesthetics and Public Well-Being – A Review

- 82) Widyo Harsanto, P., & Raras Satuti, K. (2023). Impact of Advertisements on Public Spaces and Environmental Aesthetics: Insights from Indonesia. *Journal of the International Society for the Study of Vernacular Settlements*, 10(9), 210-227. <http://digilib.isi.ac.id/id/eprint/15249>
- 83) Williams, A. T., & Rangel-Buitrago, N. (2019). Marine litter: Solutions for a major environmental problem. *Journal of coastal research*, 35(3), 648-663. <https://doi.org/10.2112/JCOASTRES-D-18-00096.1>
- 84) Williams, D. R., Neighbors, H. W., & Jackson, J. S. (2003). Racial/ethnic discrimination and health: Findings from community studies. *American journal of public health*, 93(2), 200-208. <https://doi.org/10.2105/AJPH.93.2.200>
- 85) Zacharias, J. (2001). Pedestrian behavior pedestrian behavior and perception in urban walking environments. *Journal of planning literature*, 16(1), 3-18. <https://doi.org/10.1177/08854120122093249>
- 86) Zazzi, H., & Faragher, R. (2018). 'Visual clutter' in the classroom: voices of students with Autism Spectrum Disorder. *International Journal of Developmental Disabilities*, 64(3), 212-224. <https://doi.org/10.1080/20473869.2018.1468619>
- 87) Zheng, F., Hou, F., Chen, R., Mei, J., Huang, P., Chen, B., & Wang, Y. (2021). Investigation of the relationship between subjective symptoms of visual fatigue and visual functions. *Frontiers in neuroscience*, 15, 686740. <https://doi.org/10.3389/fnins.2021.686740>
- 88) Zube, E. H., Sell, J. L., & Taylor, J. G. (1982). Landscape perception: research, application and theory. *Landscape planning*, 9(1), 1-33. [https://doi.org/10.1016/0304-3924\(82\)90009-0](https://doi.org/10.1016/0304-3924(82)90009-0)



There is an Open Access article, distributed under the term of the Creative Commons Attribution – Non Commercial 4.0 International (CC BY-NC 4.0) (<https://creativecommons.org/licenses/by-nc/4.0/>), which permits remixing, adapting and building upon the work for non-commercial use, provided the original work is properly cited.

Some Measures to Advance the Positiveness of Preschool Children in Shaping Activities



Nguyen Thi Ngoc Diep

Thu Dau Mot University

ABSTRACT: Shaping activities is an artistic learning activity. In preschool, shaping activities include activities such as drawing, molding, cutting, tearing, pasting, assembling... This activity has a great effect in educating and forming the personality of preschool children, form in children love for people, love for nature, love for life, love for beauty. Therefore, preschool teachers need to have measures to help children positive participate in activities, bringing them emotions, excitement and passion to implement their ideas.

KEYWORDS: preschool children, positive, shaping activities

I. INTRODUCTION

In the preschool education program, shaping activities play a very important role, as a basic means for aesthetic education and comprehensive education for children right from the first years of life. This is one of the most attractive activities for preschoolers, it helps children learn, discover and vividly express what they see in the world around them, what moves them strongly. And cause children positive emotions and feelings.

Through shaping activities, children are provided with basic knowledge about shaping to help them expand their understanding, develop their perceptual abilities, form their thinking abilities, and develop, emotions, especially aesthetic development. In the current context of teaching innovation, it is a necessary requirement for preschool teachers to have measures to organize creative activities to promote children's positivity.

II. RESEARCH RESULTS

2.1. Concept

Shaping activities is an artistic creative activity belongs to the field of shaping arts, studying the rules and methods of creating beauty by: points, lines, shapes, arrays, blocks, colors... The result of the activity is beauty from works or visual products that reflect the personal values of the creative subject. The products of the activities ensure novelty, actively contributing to improving and improving social life both spiritually and materially. (Chu Anh Son, 2023).

Shaping activities include the following types of activities:

- Drawing: Drawing is to create images of things on a flat surface using lines and colors. A drawing is a collection of lines and colors according to the principle of fixed painting on a flat surface, reflecting the shape of a certain object in nature.

- Squeeze: Squeeze is a form of activity where children use force with their hands to change the shape of soft, flexible materials to create the image of a cubic object according to the intended model.

- Cutting, tearing and pasting: Cutting, tearing and pasting is the activity of pressing thin, soft material edges together into folds, many times to general image of an object. Teaching children to create pictures from pieces of colored paper pasted on background paper is called tear-and-paste or collage (pieces of paper cut with scissors are called cutting and pasted paintings, pieces of paper torn by hand are called tearing and pasted paintings).

- Paper folding: Teach children to fold basic paper folds to create the shape of objects let children play.

- Puzzle: Teach children to use raw materials such as seeds, leaves, sticks... to form basic shapes and combine them to create the shape of objects.

Some Measures to Advance the Positiveness of Preschool Children in Shaping Activities

2.2. The role of shaping activities for preschool children

Shaping activities are a means of aesthetic education for children. Children recognize beauty and express emotions before beauty, develop aesthetic taste and creative ability. During the process of participating in shaping activities, children's understanding of shapes, sizes, and colors increases. The color of the object's position in space... increases. At the same time, children's psychological activities are promoted, trained and developed such as the ability to observe, analyze and synthesize, compare, remember, imagine, and visualize and think.

Children's language also develops, their vocabulary becomes richer thanks to the process of analyzing, evaluating objects, and commenting on their and your products.

Form in children good qualities such as positivity, self-control, knowing how to listen and perform tasks, knowing how to carry out work to the end, knowing how to overcome difficulties, and helping friends

Children know how to use some active tools (pencils, brushes, scissors), which also promotes children's intellectual development. In addition, children's participation in preparing and cleaning up supplies after school has the effect of forming a love of labor.

2.3. Content of shaping activities for preschool children

According to author Le Thanh Thuy: "The content of visual arts activities in preschools is considered a system of educational tasks and develops children's aesthetic perception ability, reflecting the outside world through The process of active operation with diverse sources of media and shaping materials". (Le Thanh Thuy, 2004)

The content of shaping activities includes:

- Specialized capabilities for shaping activities
- Special knowledge for shaping activities
- Specialized skills for shaping activities

The content of shaping activities for preschool children in the 2021 Preschool Education program is determined as follows:

- Content of shaping activities for children under for 3 years old: Drawing, tearing and pasting, looking at pictures.
- Content of image-making activities for children 3 – 6 years old: Feel and express emotions before the beauty of objects and phenomena in nature, life and art; Some skills in shaping activities; Express your creativity when participating in shaping activities.

2.4. Current status of children's positivity in creative activities at some preschools in Binh Duong province

To study the current state of children's positivity in creative activities (drawing, sculpting, cutting, pasting, etc.) at some preschools in Binh Duong province, we used a questionnaire to poll 105 preschool children. Preschool teachers are teaching classes at 7 preschools in Binh Duong province. In addition, I also used other methods during the survey to confirm the results from the referendum: interviews, observations of children participating in creative activities. The results of the survey on the current situation show that all teachers realize the importance of promoting children's active participation in shaping activities. This is extremely necessary and important. Current results on children's level of active participation and skill in shaping activities such as:

Serial	Skill	Very high (%)	High (%)	Medium (%)	Low (%)	Very low (%)
1	Use pencils, crayons, modeling clay, scissors...	28	37	31	7	2
2	Observe and analyze samples	17	33	63	19	8
3	Use lines, shapes, geometric shapes...	24	28	33	13	7
4	Arrange the layout	14	31	42	12	6
5	Color coordination	21	32	35	13	5

Regarding children's shaping skills, the survey results show that the skills to use tools such as pencils, crayons, modeling clay, scissors... and the skills to use lines, shapes, geometric shapes... performing shaping tasks accounts for a high rate. However, in terms of observation skills, sample analysis, and product layout arrangement, the rate isn't high. Children do not yet know how to observe and analyze sample products to form symbols about things. The layout of product is not harmonious or balanced.

Some Measures to Advance the Positiveness of Preschool Children in Shaping Activities

Serial	Criteria	Very high (%)	High (%)	Medium (%)	Low (%)	Very low (%)
1	Children are interested and voluntarily participate in activities	6.7	23.8	61.9	5.7	1.9
2	Focus on product implementation	11.5	52.4	18.1	12.4	5.5
3	Proactively carry out tasks without needing reminders	18.1	20.0	43.8	13.3	4.8
4	Completed product	21.9	40.9	29.5	6.7	1.0
5	Comply with the teacher's requests	20.9	53.3	20.1	3.8	1.9
6	Products show creativity	11.4	25.7	47.6	10.5	4.8

The results show that the percentage of children interested in participating in drawing, squeeze, cutting, tearing and pasting activities... is not high (the high and very high rate is only 30.5%). The number of children who need to be reminded to do activities is still high. At the same time, the percentage of children who are not interested in activities is high, so the level of creativity expressed in children's products is still low. Therefore, it is necessary to have measures to increase children's active participation in various types of creative activities.

2.5. Measures to increase positivity of preschool children in shaping activities

With the above contents of shaping activities and the benefits that shaping activities bring to children, preschool teachers need to have appropriate measures to enhance their active participation in activities such as:

2.5.1. Measures: Create a favorable operating environment to promote children's positivity.

For preschool children, play is the main activity. A beautiful classroom environment is a factor that directly impacts children every day. A space with rich colors will help children shape their aesthetics. In order for children to develop their shaping skills and meet current educational needs, teachers regularly change the outside of the classroom environment and inside of the classroom environment according to the theme of creating new spaces and decorating creative shaping corners. Eye-catching but not far from educational goals so that children are interested in participating.

* Environment inside the classroom:

Decorate the classroom, collect different materials, and arrange diverse and rich corners suitable for children. In particular, the shaping corner is designed to be close and exciting for children to work on

When decorating, teachers make the most of the environment around the classroom, exploiting available equipment and utensils, adding homemade utensils and toys to ensure connectivity, naturally transforming the classroom space. Learning becomes close and friendly with educational meaning for children, teacher is pay attention to appropriate layout and arrangement, to create a good and comfortable learning environment for children.

The shaping angle is arranged appropriately between motion and stillness, near the door to take advantage of natural light. Topical pictures hang in the classroom within reach of children. Pictures must be aesthetic and harmonious to raise children's awareness of picture composition, colors, and lines, especially in the art corner. Utensils are displayed in a way that is easy for children to observe, easy to take, easy to store, and the decorative content is regularly changed so that children do not get bored, giving children a feeling of excitement and desire to recreate. From there, it stimulates the desire to participate in creating art products so that the products can be decorated in the classroom. For example, in the shaping corner, the teacher and children name the activity corner such as "talented artist", "skilled child"

Regularly hang sample paintings in the art corner, save and hang children's art products in the art corner and the child's product corner for parents to observe. Children's drawings and products should be used to decorate the corners of storage boxes, windows, etc. to encourage children to have many creative ideas.

Some Measures to Advance the Positiveness of Preschool Children in Shaping Activities

Choose a location to hang the children's products, children can comment on the products themselves, and encourage them to make as many beautiful products as possible to decorate the shaping corner. Teaching aids include teaching aids for teachers and children's learning aids. In order for the lesson to be effective, it is necessary to carefully prepare materials to be proactive when instructing children, so that children do not get interrupted when observing and performing.

* Environment outside the classroom

To maximize the effects of the activity environment for children, teachers create additional environments outside the classroom that contribute significantly to arousing children's interest in creative activities. Teachers decorate the environment outside the classroom such as painting on the walls around the classroom, school, drawing on the school yard, benches... so that children can freely observe and feel the beauty everywhere around the school yard. Thereby providing increasingly rich symbols of things.

2.5.2. Measures: Create conditions for children to be exposed and enriched with symbols of things

In addition to creating an environment for children to participate in activities, teachers need to create conditions for children to interact with the surrounding environment, providing rich symbols about objects, allowing children to explore for themselves using senses, your own inherent experiences to perceive different objects.

In the process of providing symbols about shaped objects, teachers need to show children the outstanding features and interesting beauties that are close to them. At the same time, help children find the unique and common characteristics of phenomena of the same group and type. From there, help children find ways to express their ideas. For example, in the preschool theme, the activity "Drawing a picture of a flower garden in the school yard" has tall flowers, low flowers, round-petaled flowers, long-petaled flowers, and flowers of different colors. Before the shaping activity takes place, the teacher lets the children see the real flower garden so that when creating the pictures, the children will know how to use skills and ways to color and combine colors more vividly and beautifully than just looking at them.

2.5.3. Measures: Increase making of utensils and toys to serve shaping activities

In order for children to be interested in shaping activities, materials are indispensable. children want to create beautiful, creative products in addition to using purchased tools, materials and collecting waste materials or natural materials to increase the variety of materials and diversity.

Teachers propagate and mobilize parents of the class during pick-up and drop-off hours to donate materials such as: pictures, old newspapers, toilet paper rolls, candy boxes, cans, storage boxes, bottle caps, etc. ... seemingly discarded materials are an extremely rich treasure trove of materials that children can use as materials for shaping activities. Note that when collecting and selecting materials, they must be clean, dry, and arrange items neatly so that children can easily see them and use them when needed.

From waste materials such as paper cores, cut into flower shapes, heart shapes, star shapes or circles... so that they can be used to create different shapes in watercolor printing activities. Cotton swabs can replace brushes when drawing to make a difference. For example, in the topic "Preschool" in the activity "Drawing a picture of a flower garden in the school yard", children can use a variety of materials such as paper cores, cotton swabs, flower-shaped sponges, etc. to Children freely choose materials to help them create creative flower garden paintings. Or from seemingly discarded ingredients like bean residue combined with watercolor and decorative materials like pebbles, leaves... children create animal pictures with their own hands, helping them become skillful. , more flexible, children's imagination is richer.

Using leftover paper and old calendars, teachers help children make books, then let them collect pictures to cut or tear and paste, each child feels the beauty of their own book.

If recycled materials are abundant, natural materials are equally diverse. Teachers and children collect other natural materials such as: grains, twigs, dry leaves, all kinds of seed shells, eggshells, wool, straw fibers... From pumpkin seeds and sunflower seeds combined with drinking straws, beautiful flower paintings made from seeds can also be created... The diversity of shaping materials will increase children's interest, children can easily choose their own way of expression and create a means of creating suitable for their abilities. Children can unleash their imagination and creativity with natural materials.

Clay molding activities that require the teacher to prepare clay and take advantage of naturally available materials such as mussel shells, styrofoam, and sunflower seed shells, so that when children shape, they can combine the Scraps make children's works more lively and creative. For example, on the topic of natural phenomena, the activity of creating clouds with cotton, in addition to preparing colorful cotton for children to shape clouds, collect materials such as bottle caps for children to creatively make the sun. Straws to make rain, yarn to make rainbows

In addition, children also use seeds to create products of their choice. So, collecting creative materials and supplies has contributed to helping children develop imaginative thinking and creativity.

Some Measures to Advance the Positiveness of Preschool Children in Shaping Activities

2.5.4. Measures: Teachers are flexible in using many different forms

Teachers flexibly organize children to participate in shaping activities through many different genres and forms. Organize different types of activities for children to participate in such as shaping activities according to the model, shaping according to topic, shaping freely, decorating and in many different forms such as shaping in class, shaping outside of class, shaping in groups... For example, on the same animal theme, teachers let children do many different types of activities such as: molding chicks, drawing roosters, drawing chickens, tearing and gluing rabbits... Organize shaping activities according to group: Activities to create conditions for many children to participate in creating products. For example, during an hour of drawing, prepare a lot of materials for children to make, some children combine hand prints to create a picture.

2.5.5. Measures: Incorporate shaping tasks into other activities

Shaping activities is a very important activity in children's daily activities because children can perform shaping tasks anytime, anywhere. The first is outdoor activities, In this activity, teacher can combine shaping activities into purposeful activities or play freely by using chalk to draw as desired on the brick floor, making toys with materials. Natural locally available materials such as: gravel, clam shells, leaves, twigs,... create very cute and funny pictures of flowers. At times like these, children are very interested and want to follow their teachers, even though the number of children can do very small, but it creates curiosity and a desire to explore. For example children pick up many types of leaves, or from jackfruit leaves and fallen almond leaves along with string, they can create funny buffaloes.

Next is the play activity in the corners. In this activity, children are free to choose a play corner at the shaping corner, children draw, sculpt, cut, tear, paste, make toys,... according to their preferences.

In the afternoon activities, teachers can also combine shaping activities such as re-doing shaping activities that children have not completed or letting children make flowers through learning and movement games, for example in afternoon review time for children to make paintings for their mothers and aunts, and organize a contest to vote for talented artists of the class.

In addition, in other learning activities such as In activities to get acquainted with Math, children can draw or color empty numbers,... In activities to get acquainted with literary works, children can color the characters in the story or tear and paste the characters your child likes. Activities to familiarize children with letters by coloring empty letters or writing letters. Science discovery activities for children to draw animals, trees, flowers, vehicles,

2.5.6. Measures: Do a good job of propaganda and coordination with parents

To create an environment for children to become familiar with shaping activities, teachers coordinate with parents so that parents clearly understand the roles and responsibilities of family and school.

Teachers coordinate with parents to observe which skills children are weak in. Teachers discuss with parents during pick-up and drop-off times so that parents can promptly grasp and train their children further at home and come up with ways to further practice children's shaping skills. For example, in the topic of the child's beloved family, the drawing activity "Family members" had some people's people-drawing skills being weak, so at the end of the day, during drop-off time, Teachers also discussed with the parents and asked them to help. Parents practice drawing skills for children at home. At the same time, the teacher also stimulates the children in advance by asking them, "What picture can you draw today?" When you get home, please redraw the picture in class to give to your grandparents and parents!"

Teachers discuss with parents to collect waste materials to make utensils and toys such as pieces of Styrofoam, candy boxes, cardboard... In addition to mobilizing parents to support funding and materials, parents can be mobilized to spend time in class to help teachers make toys.

III. RESULTS AND DISCUSSION

Shaping activities is one of the attractive and indispensable activities for children in preschool. When participating in this activity, children can develop their ability to perceive, analyze, synthesize, and perform thinking operations, developing creative imagination and forming in children skills, techniques, and perceptual abilities about the shape, structure, and color of objects. Children actively participate in activities that help them express their skills, thinking, emotions and ingenuity. Besides children are actively active, they also learn to be careful and patient when doing things. Children is develop aesthetically through observing and learning about the surrounding environment. That is why measures to improve children's activeness are necessary

REFERENCES

- 1) Le. T. T. (2004). *Methods of organizing shaping activities for preschool children*. Hanoi Pedagogical University Publishing House
- 2) Chu. A. S... (2023). *Training skills in organizing creative activities for pedagogical college students majoring in Early Childhood Education*. Doctoral thesis, Hanoi Pedagogical University.

Some Measures to Advance the Positiveness of Preschool Children in Shaping Activities

- 3) Ministry of Education and Training. (2021). *Preschool education program*. Vietnam Education Publishing House
- 4) Nguyen. A. T. (1992). *Beauty education for children*. Hanoi Education Publishing House
- 5) Nguyen. Q. T. (2007), *Methods of organizing visual activities for preschool children*, Hanoi Education Publishing House
- 6) Le, H. V. (2001). *Creating shapes and methods of guiding shaping activities for children (Book III - Methods of guiding shaping activities for preschool children)*. Hanoi National University Publishing House
- 7) Nguyen, N. Q. (2005). *Modern Educational Methods*. Vietnam National University Publishing House.
- 8) Le, T. V. (2015). *Child Physiology Textbook*. Vietnam National University Publishing House
- 9) Felicity McArdle & Barbara Piscitelli, 2002. *Early childhood art education: A palimpsest*. Australian Art Education, 25(1), 11-15.
- 10) Danielle Twigg; Susanne Garvis, 2010. *Exploring Art in Early Childhood Education*, Griffith University, Queensland, Australia.

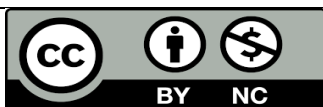

There is an Open Access article, distributed under the term of the Creative Commons Attribution – Non Commercial 4.0 International (CC BY-NC 4.0) (<https://creativecommons.org/licenses/by-nc/4.0/>), which permits remixing, adapting and building upon the work for non-commercial use, provided the original work is properly cited.

The Effect of Audio-Visual Learning Media on the Memory of Elementary School Students



Erna Mena Niman¹, Zephisius Rudiyanto Eso Ntelok², Heronimus Emilianus Arjono Wejang³, Stefanus Divan⁴

^{1,2,3,4} Universitas Katolik Indonesia Santu Paulus Ruteng

ABSTRACT: This study aims to determine the effect of using audio-visual learning media on students' memory through the learning outcomes test. This research was conducted using an experimental method involving two classes, namely the experimental class and the control class. The results showed that the experimental class, which used learning media, had quite good learning outcomes after using audio visual, when compared to conventional classes that did not use audio visual learning media. Thus it can be concluded that the increase in learning outcomes in the experimental class shows that students have a good memory of the material they learn through audio visual learning videos. Future researchers are expected to further examine the use of audio-visual learning media from different perspectives.

KEYWORD: audio-visual learning, memory

INTRODUCTION

Advances in science and technology have brought changes in all sectors of human life, including in the realm of formal education. Education is one of the most important things in human life. Education is an effort to help the souls of students both physically and mentally, from their nature towards a humane and better civilisation (Sujana, 2019). Education makes a very real contribution in helping to provide a skilled, educated, and knowledgeable workforce that is relevant to market demands so that it can open the door to shared prosperity and has an important role in creating innovation and increasing productivity (Roseno & Wibowo, 2019., Purwo, 2017., Aini et al., 2018). In an effort to develop the intellectual level and personality of students, it is necessary to plan and implement an education system that applies to everyone in order to create new innovations (Rahayu et al, 2021., Nisrokha, 2018., Dimiyati and Mudjiono, 2015). This can be realised through an effective learning process that is able to meet the learning needs of students. The learning needs of each learner are unique. According to R. Herdlein and E. Zurner (2015) and Sugiharton, et al (2007) that the learning process that can respond to students' learning needs through meaningful activities that involve students in it is one part of the characteristics of effective learning.

Education, by its very nature, involves communication between teachers and learners with the aim of helping learners to achieve educational goals. Educational interaction occurs in the school environment to provide learners with better knowledge and understanding through the learning process. Learning is an effort to make students learn or an activity to teach students (Supriatna, 2020). This is inseparable from the role of the teacher. The role of the teacher as the main facilitator in the learning process covers various aspects, starting from ensuring the presence of students, delivering learning materials, motivating, guiding, to evaluating learning outcomes, Stenhouse, et al. (Putra and Pratama, 2023).

Effective implementation of learning in an effort to improve learners' memory related to remembering information conveyed in learning. The ability of learners to remember important information in learning is necessary. Strong memory helps learners absorb the knowledge taught at school. Syariah, (Anisah and Maulidah, 2022) said that the ability to remember or memory is an important component in the process (encoding), storing (storage) and reissuing information (retrieval) in memory. Therefore, teachers must actively increase their creativity, to provide learning media that can create effective learning situations and can improve students' memory, so that it has an effect on improving learning outcomes.

Learning media is very important in the learning process. The use of various media in learning can help avoid monotony in learning and make learning more interesting and diverse. The lack of learning information sources can hinder the achievement

The Effect of Audio-Visual Learning Media on the Memory of Elementary School Students

of learning process goals, for this reason, strategies are needed in the learning process, including by utilising learning media as a tool in delivering it (Firmadani, 2020). To assist in conveying knowledge, information from the subject matter provided to students, the author chose Audiovisual as a medium to assist in the teaching and learning process. The use of technology in learning can support the development of spiritual, intellectual, social, emotional, kinesthetic and other potential aspects of learners (Sista, 2017). The use of Audiovisual as a media solution to help teachers facilitate the delivery of learning materials and make it easier for students to understand the material delivered by the teacher and can help to improve their memory.

By utilising Audio-visual as learning media, it can raise the enthusiasm of students, so that students are more active and can improve memory. However, the reality that occurs in the researcher's place is that some teachers have not utilised Audio-visual as a learning medium, with several reasons such as the lack of knowledge of teachers to access videos and the reluctance to search and prefer to teach as usual, namely conventional by only using books that have been provided from schools and sometimes using makeshift image media. This certainly has an impact on the enthusiasm for learning of students to be low and affects memory which in turn low student learning outcomes. The use of media that is very dominant in the learning process at school certainly causes students' enthusiasm for learning to be low and affects memory.

Several previous studies related to the use of audio visual media including Gabriela (2021), Novita, L., and Vovianty, A (2020), Fridayanti, et al. (2022), Angreiny, et al. (2020) found that the use of audio visual media has a significant effect on student learning outcomes. Previous research focuses more on science subjects and has not examined social studies material. To fill this void, the researcher will examine the use of audio-visual media in social studies subjects at Ruteng V Catholic Elementary School. This research is important to do because it has a contribution for teachers in elementary schools in an effort to utilise various teaching media that will have an impact on the interest and motivation of learning and student learning outcomes.

METHODOLOGY

This study uses quantitative research with experimental research methods. This study aims to determine the effect of audio-visual media on the memory of grade IV SDK Beokina students. Research design that uses one group pretest and posttest. One group pretest and posttest research design where one group is tested twice, namely before treatment (pretest) and after treatment (posttest) with the aim of knowing changes in the group after being given certain treatments. The subjects of this study were fourth grade students of SDK Beokina. Data analysis used prerequisite tests, namely t test, variance test and hypothesis testing.

RESULTS AND DISCUSSION

1. T test

The sample mean comparison test is used to compare the results in the experimental class with the control class to analyse the research data then tested with the t test to ensure there is a difference between the experimental class and the control class. The data is presented in the following auxiliary table from the experimental and control class posttest data in the following table.

Table 1. T-test auxiliary table of experimental class and control class

Learner's serial number	Posttest	
	Experimental class	Control class
1	28	22
2	25	22
3	26	24
4	27	22
5	25	23
6	25	20
7	25	21
8	24	24
9	25	23
10	24	22
11	26	23
X	25,455	22,364
S ²	1,473	1,455

From table 1, it is known that the average and variance are the average of the experimental class = 25.455, the average of the control class = 22.364, the variance of the experimental class = 1.473, and the variance of the control class = 1.455. based on these

The Effect of Audio-Visual Learning Media on the Memory of Elementary School Students

data, the results of the analysis of the calculated t value are $t = 1.340$ then compared with $\alpha = 0.05 = 0.413$. It can be concluded that the calculated t value of 1.340 is greater than the critical value of the 0.05 level = 0.413. So the use of audio-visual media in the learning process of social studies has a difference with the use of media konvensional.

2. Analysis of Variance (ANOVA)

After conducting a mean comparison test followed by analysis of variance, the variance analysis will test the variations between the experimental class and the control class, the total variation and the interaction variation between the two factors and their effect on the dependent variable (students' memory). Hypothesis testing using the F test with calculation steps and assisted with Microsoft Excel as follows.

Table 2. ANOVA auxiliary table

Learning Outcomes	Strategi Pembelajaran		Number of Rows
	Audiovisual	Konvensional	
(B)	(A1)	(A2)	
High (B1)	28	22	
	25	22	
	26	24	
	27	22	
	25	23	
	25	20	
	25	21	
	24	24	
	25	23	
	24	22	
26	23		
n	11	11	22
$\sum X$	280	246	526
$\sum X^2$	7142	5516	12658
Low (B2)	22	20	
	23	21	
	23	26	
	18	22	
	19	19	
	22	23	
	23	21	
	23	24	
	18	19	
	21	23	
22	23		
n	11	11	22
$\sum X$	234	241	475
$\sum X^2$	5108	5237	10345
N	22	22	44
$\sum X$	514	487	1001
$\sum X^2$	12250	10753	23003
$\sum X$	23,36363636	22,13636364	45,5

Based on the data in table 2, it can be found that the f count is 13.133. This result is greater than the F table when compared to the F table value at a level of 0.05. So it can be concluded as follows: 1) There is a difference in the memory of students who are treated (using audio-visual media) with students who use conventional media as measured through learning outcomes tests. 2) There is a difference in memory between students with high motivation and low motivation as measured by the learning outcomes

The Effect of Audio-Visual Learning Media on the Memory of Elementary School Students

test. 3) There is an interaction between the learning process by using audio-visual media and there is an influence on the memory of students measured through the learning outcomes test.

3. Hypothesis Testing

Because there is an interaction, the analysis is continued with the post ANOVA test with Tuckey's HSD formula to compare the means with the help of Microsoft Excel. Based on the HSD value, an average comparison between classes can be made with the condition: if the average difference between the compared classes is greater than HSD, then the difference is significant. It is known that the average of group A = 25.455 and group B = 22.182. The test results can be seen in the following table

Table 3. Hypothesis testing

comparison	Average difference	Total	HSD value	Conclusion
A-B	25,455-22,182	3,273	0,7	significant
B-A	22,182-25-445	-3,273	-0,7	not significant

From the data in the table of learning outcomes, the average in group A (experimental class) is higher, it can be concluded that audio-visual media is more effective in improving students' memory compared to conventional media. While the average comparison between classes using audio-visual media obtained significant results because it was greater than the HSD value and classes using conventional media obtained insignificant results.

DISCUSSION

Based on the results of data analysis, it was found that the use of audio-visual media in the experimental class in the learning process had an influence on students' memory. In the t test analysis, it shows that there is a difference between the class that is treated using audio-visual media and the class that uses conventional media, namely the value of t count = 1.340 is greater than the critical t at the 0.05 level, namely = 0.413. The difference is because audiovisual media in the social studies learning process has advantages as explained by Gabriela (2021) that the advantages of audiovisual media are that it provides very clear information, can describe real circumstances, is more realistic, can be repeated as needed. In addition, audio-visual media teaches students to find their own answers to problems through the process of seeing and hearing.

In the analysis (ANOVA) of the three F values (row, column, and interaction) compared to the value of F table = 4.08, F count between rows = 20.321, F count between columns = 5.695, and F count between interactions = 13.133 then F count is greater than F table so it can be concluded as follows:

1. There is a difference in memory between students who are taught using audio-visual media and conventional media.
2. There are differences in learning outcomes between students with high motivation and low motivation.
3. There is an interaction between learning using audio visual media and its effect on memory.

Based on the HSD value in the hypothesis test, an average comparison between the experimental class and the control class is made, namely $A-B = 25.455 - 22.182 = 3.273$, $B-A = 22.182 - 25.455 = -3.273$ compared to the HSD value of 0.7, it is concluded that the average comparison between classes using audio-visual media obtains significant results because it is greater than the HSD value and classes using conventional media get insignificant results because it is smaller than the HSD value. The significant difference in students' memory is influenced by the learning media used by the teacher. One of the adjustment factors related to teaching is the learning method by utilising the right learning media. The selection of appropriate learning methods and media can have a significant impact on the effectiveness of learning (Banani, 2017). Interactive, creative, and motivating learning methods and media can stimulate students to engage in the learning process directly (Purwanti et al., 2014; Masnawati et al., 2022;). Thus the use of learning media needs to be mastered by teachers, so that they can convey learning materials to students properly, and efficiently (Wulandari, et al., 2023: 3929).

The significant research results are inseparable from the teacher's strategy in using audio-visual media that can attract students' attention and generate learning motivation in students, so that learning becomes more meaningful. Appropriate use of learning media can attract attention, increase students' interest and motivation to learn, and make the learning process more interactive and not monotonous, so that students are not bored in the teaching and learning process (Wahyono, 2020., Audie, 2019). This is very helpful for students in remembering material through what they see and hear. The ability to remember or memory is an important component in the process (encoding), storing (storage) and reissuing information (retrieval) in memory (Anisah and Maulidah, 2022). This ability has been proven through different learning outcomes between the experimental and control classes in this study. Thus the use of audio-visual media in learning is feasible to use because it can improve student memory.

The Effect of Audio-Visual Learning Media on the Memory of Elementary School Students

CONCLUSION

The use of audiovisual learning media as one of the solutions to help facilitate teachers in delivering learning materials, as well as helping to make it easier for students to remember and understand the material studied, thus increasing their memory which has an impact on improving learning outcomes. In this study, it was found that there were differences in student learning outcomes in experimental classes with students in conventional classes. The difference is characterised by a significant increase in learning outcomes in the experimental class when compared to the conventional class. The difference in learning outcomes proves that the use of audiovisual learning media is more helpful for students in terms of memory on the material they are learning. These results support some previous research related to the use of audio-visual media in the learning process. Thus the use of audio-visual learning media is feasible to use to improve memory as measured in student learning outcomes. Future researchers are expected to examine the use of audiovisual learning media from different perspectives.

REFERENCES

- 1) Angreiny, dkk. 2020. Pengaruh Penggunaan Media Audio Visual Terhadap Motivasi dan Hasil Belajar IPA Siswa Kelas V SD Negeri Bontoramba. *Edumaspul Jurnal Pendidikan*, 4(1), 42–49
- 2) Aini, E. N., I. Isnaini., S. Sukamti., & L. N. Amalia. 2018. Pengaruh Tingkat Pendidikan Terhadap Tingkat Kesejahteraan Masyarakat di Kelurahan Kesatrian Kota Malang. *Technomedia Journal*, 3(1), 58-72.
- 3) Anisah dan Maulidah. 2022. Meningkatkan Kemampuan Daya Ingat Peserta didik Melalui Metode Bernyanyi Pada Mata Pelajaran Sejarah Kebudayaan Islam. *Jurnal Pendidikan UNIGA*, 16(1), 581–591.
- 4) Banani. 2017. Pengaruh Kepemimpinan Kepala Sekolah Terhadap Kompetensi Guru dalam Mewujudkan Efektivitas Pembelajaran. *Jurnal Pendidikan UNIGA*, 11(1), 67-76.
- 5) Dimiyati & Mudjiono. 2015. *Belajar dan Pembelajaran*. Jakarta: PT. Rineka Cipta
- 6) Firmadani, F. 2020. Media Pembelajaran Berbasis Teknologi Sebagai Inovasi Pembelajaran Era Revolusi Industri 4.0. *Prosiding Konferensi Pendidikan Nasional*, 2(1), 93–97.
- 7) Fridayanti, dkk. 2022. Pengembangan Media Pembelajaran Audio-Visual Pada Materi Hidrosfer Untuk Mengukur Hasil Belajar Peserta Didik SMP/MTS. *JUPEIS : Jurnal Pendidikan Dan Ilmu Sosial*, 1(3), 49–63.
- 8) Gabriela. N.D. Pancasari . 2021. Pengaruh Media Pembelajaran Berbasis Audio Visual Terhadap Peningkatan Hasil Belajar Siswa Sekolah Dasar. *Jurnal Pendidikan Guru Sekolah Dasar*, 2 (1), 104-113
- 9) Masnawati, E., N. D. Aliyah., M. S. Djasilan., D. Darmawan., & Y. Kurniawan. (2022). Dynamics of Intellectual and Creative Development in Elementary School Children: The Roles of Environment, Parents, Teachers, and Learning Media. *International Journal of Service Science, Management, Engineering, and Technology*, 1(1), 33-37.
- 10) Nisrokha. 2018. Authentic Assessment (Penilaian Autentik). *Jurnal Madaniyah*. 8(2).Hal. 209- 229
- 11) Novita, L., & Novianty, A. 2020. Pengaruh Penggunaan Media Pembelajaran Audio Visual Animasi Terhadap Hasil Belajar Benda Tunggal Dan Campuran. *JTIEE (Journal of Teaching in Elementary Education*, 3 (1), 46-53
- 12) Purwo, S. 2017. Peran Gerakan Literasi Sekolah dalam Pembelajaran Kreatif-Produktif di Sekolah Dasar. *Dewantara*, , 3(1), 85-103.
- 13) Purwanti, S., T. Palambeta., D. Darmawan., & S. Arifin. (2014). Hubungan Metode Pembelajaran dan Motivasi Belajar Siswa. *Jurnal Ilmu Pendidikan*, 8(1), 37-46
- 14) Putra dan Pratama. 2023. Pemanfaatan media dan teknologi digital dalam mengatasi masalah pembelajaran. *Journal Transformation of Mandalika*, 4(8), 323–329.
- 15) Rahayu.L. Puji, Khutobah, Budyawati.L.P. Indah.2021. Peran Guru Dalam Pembelajaran Terhadap Kedisiplinan Anak Kelompok B. *Journal Of Early Childhood Education And Research*, 2 (1), 1-11.
- 16) Richard Herdlein and Emily Zurner. 2015. Student Satisfaction, Needs, and Learning Outcomes: A Case Study Approach at a European University. *SAGE Open*, 5 (2), 1-10
- 17) Roseno, I., & Wibowo, U. B. 2019. Efisiensi Eksternal Pendidikan Kejuruan di Kota Yogyakarta. *Jurnal Akuntabilitas Manajemen Pendidikan*, 7(1), 15-24.
- 18) Sista, T. R. 2017. Implementasi Manajemen Kurikulum Dalam Meningkatkan Mutu Pendidikan. *Jurnal Educuan*, 1(1), 25–45.
- 19) Sugiharton , et al (2007). *Psikologi Pendidikan* . Yogyakarta: UNY Press
- 20) Sujana, I. W. C. 2019. Fungsi Dan Tujuan Pendidikan Indonesia. *Adi Widya: Jurnal Pendidikan Dasar*, 4(1). 29-39
- 21) Supriatna .E, 2020. Penerapan Model Pembelajaran Problem Based Learning (PBL) untuk Meningkatkan Hasil Belajar Siswa. *Journal of Classroom Action Research*. 2 (1), 15-19.



There is an Open Access article, distributed under the term of the Creative Commons Attribution – Non Commercial 4.0 International (CC BY-NC 4.0) (<https://creativecommons.org/licenses/by-nc/4.0/>), which permits remixing, adapting and building upon the work for non-commercial use, provided the original work is properly cited.

Examination of the Impact of System Quality, Information Quality, and Service Quality on Net Benefits through User Satisfaction in the Performance of State Civil Apparatus in the Malang District Government



Sigid Tri Hartanto¹, Mokhamad Natsir², Yusaq Tomo Ardianto³

^{1,2,3} Postgraduate Program, University of Merdeka Malang, Indonesia.

ABSTRACT: Information technology investment is currently occurring rapidly and has become a necessity in an organization, both in the business environment and in the government environment. The various characteristics of information systems created with all their advantages and disadvantages have become an arena for competition in terms of innovation to show the superiority of the organization. The Civil Servant Performance Information System is the management and procedures for collecting, processing, analyzing, presenting, utilizing, and documenting civil servant performance data in an integrated manner. The net benefits of an information system are influenced by system quality, information quality, service quality, and user satisfaction. This research aims to analyze the influence of system quality, information quality, and service quality on net benefits through user satisfaction in the Malang Regency Government. This research is quantitative research with a saturated sampling method, so a sample of 72 respondents was obtained. The data analysis techniques used are descriptive analysis, classical assumption test, t-test, and path analysis. The research results concluded that system quality, information quality, and service quality have a significant effect on user satisfaction with civil servant performance information systems. User satisfaction also has a significant effect on the emergence of net benefits from the performance information system.

KEYWORDS: System Quality, Information Quality, Service Quality, User Satisfaction, Net Benefit, Performance System

I. INTRODUCTION

The world of information technology is currently developing so rapidly and has become a necessity in an organization, both in the business sector and in the government sector. Various characteristics of information systems that are created with all their advantages and disadvantages have become a competition arena in terms of innovation to show the superiority of the organization that houses them. The existence of technology and information used in an organization, both small and large, has now become the main commodity in competition in the era of globalization (Buana and Wirawati, 2018). In line with that, Dandago and Rufai (2014) stated that information technology is one of the resources that must be available in an organization because it will only cause optimal decision-making. The government of the Republic of Indonesia currently also wants to be included in terms of building an information system to support various government affairs such as public service innovation, financial systems, and administration systems to manage the performance of its apparatus. This is shown in the development of several current government regulations that always juxtapose the use of information systems in the implementation process. Likewise, the Malang Regency Government, as a form of compliance with rules related to performance management, in this case, Government Regulation (PP) Number 30 of 2019 concerning Civil Servant Performance Assessment, which is then further outlined in the Regulation of the Minister of Empowerment of State Civil Apparatus and Bureaucratic Reform (PermenPANRB) Number 6 of 2022 concerning Management of State Civil Apparatus Performance, a state civil apparatus performance information system was created which is used for performance management starting from planning, implementation, assessment and evaluation of state civil apparatus performance within the Malang Regency Government which was then named the Performance Assessment Application System (*SiapKerja*).

Examination of the Impact of System Quality, Information Quality, and Service Quality on Net Benefits through User Satisfaction in the Performance of State Civil Apparatus in the Malang District Government

Changes in work culture in the government environment have also begun to shift. Several conventional procedures that have long been implemented have begun to change towards the digitalization process in order to improve the quality of service or performance management processes. In PP Number 30 of 2019, Article 60 states that the planning, implementation, monitoring, performance coaching, assessment, and evaluation of follow-up are carried out using the ASN Performance Information System so that the processes of managing the performance of state civil servants no longer use conventional assessment formats, but are directly stated in the state civil servant performance information system. The digitalization process in the field of apparatus performance also has an impact on several other personnel service processes, for example, the digitalization process of promotion which no longer requires verification of performance assessment documents in physical form or scanned documents but directly sees the performance assessment results data in the State Civil Apparatus Information System (SiASN) database. The impact of the implementation of the digitalization process in the government environment has brought about a change in mindset and a reduction in the bureaucratic flow, which has been known to be long and slow. Still, the implementation process does not mean that it runs efficiently; the gap between generations among state civil servants is one of the challenges in the implementation of digitalization in the bureaucratic environment. For state civil servants who were born as millennials or later, it will be straightforward to adapt and follow the digitalization process, but not for the opposite generation, so a gradual socialization process and technical assistance are needed to overcome these problems.

The performance of civil servants in the Malang Regency Government has also changed after the provision of additional employee income (TPP), which has been given since 2019, with the number of allowances increasing gradually every year. TPP is given as a form of appreciation for the achievement of performance results, and deductions will be made when the performance results do not reach the predetermined target, so the phenomenon of the level of attendance and compliance in working for state civil servants in the Malang Regency Government has improved. The desire to obtain TPP in full and concerns about TPP deductions imposed if the apparatus does not achieve the maximum attendance and performance targets have changed the mindset of the Malang Regency Government apparatus for the better. To create fair and transparent conditions in order to meet attendance and performance targets, a state civil servant performance information system is needed that monitors and automatically calculates the TPP acquisition for each apparatus.

The implementation of information technology systems is expected to be helpful in support activities because information systems supported by information technology can support decision-making and bring success in activities, for example, in business life, economic life, social policy, and education (James A. O'Brien & Marakas, 2017). The state civil apparatus performance information system is present as a medium in the performance management process and a solution to its digitalization process in the Malang Regency Government environment, which can help the apparatus plan, implement, assess, and evaluate performance. The presence of the performance information system will certainly have an impact on the paradigm of apparatus performance management affairs, where performance assessment and evaluation are no longer an administrative function that is merely a formality but is considered a form of compliance that must be carried out on time. Changing the mindset of the apparatus from just working to performing is not easy, and this is because the old paradigm that made the mindset of the apparatus in working was to be present and wait for orders from superiors for a job. The issuance of PP Regulation Number 30 of 2019 has mandated that every apparatus must have a performance plan by setting targets and work realization for the next year using an information system as a medium for implementation. This will be a challenge in itself, so the apparatus in the Malang Regency Government environment is able to understand the process. Assistance is needed in the form of socialization and technical guidance in the preparation of performance planning for the evaluation process. Another change that accompanies the issuance of the regulation is that the assessor officials, who in this case are the direct superiors of the apparatus, must be able to express work expectations and behavioral expectations because, in this new regulation, the information system is more to help assessor officials to make decisions about an expectation, no longer as an information system that directly measures work results based on the formulation of numbers entered into the system. This paradigm shift has challenges for assessor officials because not all performance management matters are automated by the existing information system. Instead, it requires an active role from assessor officials to understand the results that their subordinates have achieved. According to research conducted by Ichsan (2020), company goals will be achieved optimally if supported by operational methods and work techniques that can optimize the time, energy, and costs that arise and are inseparable from the quality of resources in the organization. Information is used to support the decision-making process, with computers being a tool that is definitely used in the organizational environment.

Many studies have been conducted to identify several factors that influence the success of information technology systems, one of which was conducted by DeLone and McLean. DeLone and McLean (1992) proposed a model to evaluate the level of success of information technology systems, often referred to as the D&M IS Success Model, which shows that system quality and information quality affect user usage and satisfaction. In the theory of DeLone and McLean (2023), it is explained that system

Examination of the Impact of System Quality, Information Quality, and Service Quality on Net Benefits through User Satisfaction in the Performance of State Civil Apparatus in the Malang District Government

quality, information quality, and service quality can affect user usage and satisfaction, which will then affect net benefits. Usage must precede user satisfaction, but positive use will result in greater user satisfaction. Increasing user satisfaction will also increase interest in use and further use. The net benefit is an increase in the interest and satisfaction of the information system users. Based on the explanation of the facts, the phenomena mentioned above, and supported by the theories of experts and previous research, it is stated that there is an influence between system quality, information quality, and service quality on net benefits with user satisfaction factors as intervening media. Therefore, the researcher took the research title "Analysis of the Influence of System Quality, Information Quality, and Service Quality on Net Benefit through User Satisfaction of the State Civil Apparatus Performance Information System at the Malang Regency Government."

II. LITERATURE REVIEW

Information Systems Theory

According to O'Brien, 2010, an information system is an organized combination of people, hardware, software, communication networks, information resources, policies, and procedures that store, transform, and distribute information within an organization. Humans rely on modern information systems to communicate with each other using several physical devices (hardware), communication networks (networks), and stored data (data resources). According to Whitten and Bentley, 2007, it is defined that an information system is a combination of people, processes, technology, and data structures designed to collect, process, store, and share information to support management decision-making and organizational control. In another theory put forward by Davis, 1989, it is stated that an information system is a system that receives input data and instructions, processes data according to instructions, and produces results. An information system is also a man-made system that includes a set of integrated components and computer-based manual components that aim to collect data, process data, and produce information for users (Sidharta, 1995).

Net Benefit

According to the theory presented by DeLone and McLean, 2003, it is stated that net benefit is the result of using an information system that provides benefits to individuals, groups, and organizations. Usage refers to how often users use the information system. The more systems are used, the greater the net benefit. The net benefit is the result of using a system that helps individuals, groups, and organizations. User satisfaction with the results of using the system affects user performance; the more users are satisfied with the system, the greater the user feels the system contributes. There are five indicators used by DeLone and McLean in measuring net benefit, namely (a) cost savings, (b) expanded market, (c) additional sales development, (d) reducing search costs, and (e) time savings.

III. METHOD

This research uses a positive paradigm as a line of thought that uses deductive reasoning and quantitative methods to obtain the truth. The primary data used in this research is a questionnaire that is obtained from Google Forms. The population in this study was the Head of the General and Personnel Sub-Division, the person in charge of the Regional Apparatus within the Malang Regency Government, who handled the implementation of the state civil servant performance information system, with a total of 72 people. Sampling in this study used the saturated sampling method, where all members of the population became research subjects.

The data analysis technique used is descriptive analysis for each variable and a requirements analysis test for further hypothesis testing using multiple regression and path analysis. The analysis requirements tests performed were the normality, multicollinearity, and heteroscedasticity tests. Hypothesis testing using multiple regression analysis was carried out to determine whether the independent variables partially influence the dependent variable and to determine the linear regression equation. Path analysis was carried out to determine whether the mediating variable can mediate the independent variables on the dependent variable. Analysis of needs testing, hypothesis testing, and multiple linear regression analysis equations using the help of IBM SPSS Statistics version 29 software.

IV. RESULT AND DISCUSSION

A. Result

1. Partial test (t-test)

The basis for decision-making in this partial test is that if the significance value t is < 0.05 , H_a is accepted, whereas if the significance value t is > 0.05 , H_a is rejected. Partial test results (t-test) are presented in the table 1:

Examination of the Impact of System Quality, Information Quality, and Service Quality on Net Benefits through User Satisfaction in the Performance of State Civil Apparatus in the Malang District Government

Table 1 Partial Test Results Model 1

Model	Unstandardized Coefficients	Standardized Coefficients	Beta	t	Sig.
	B	Std. Error			
Constant	3,962	0,700		5,660	0,01
System Quality (X ₁)	-0,746	0,034	-0,242	-3,082	0.03
Information Quality (X ₂)	0,425	0,046	0,945	9,132	0,01
Service Quality (X ₃)	0,147	0,41	0,258	3,609	0,01

The system quality variable (X₁) obtained a negative t-count of -3,082 with a sig. of 0.003 < 0.05. So, the system quality variable negatively and significantly affects the job satisfaction variable. It shows that hypothesis 1, which is that system quality has a significant effect on user satisfaction, is accepted.

The information quality (X₂) obtained a positive t-count of 9,132 with a sig. of 0.001 < 0.05. So, information quality is positive and significantly affects the variable of user satisfaction. It shows that hypothesis 2, which is that information quality has a significant effect on user satisfaction, is accepted.

The service quality (X₃) obtained a positive t-count of 3,609 with a sig. of 0.001 < 0.05. So, service quality is positive and significantly affects the variable of user satisfaction. It shows that hypothesis 3, which is that service quality has a significant effect on user satisfaction, is accepted.

Table 2 Partial Test Results Model 2

Model	Unstandardized Coefficients	Standardized Coefficients	Beta	t	Sig.
	B	Std. Error			
Constant	3,024	3,760		0,804	0.01
System quality (X ₁)	0,325	0,039	0,702	8,242	0,01
Information quality (X ₂)	0,370	0,036	0,775	10,882	0,02
Service quality (X ₃)	0,464	0,047	0,763	9,865	0,01
User satisfaction (Y ₁)	0,912	0,065	0,857	13,927	0,000

The system quality variable (X₁) obtained a positive t-count of 8,242 with a sig. of 0.01 < 0.05. So, the system quality variable positively and significantly affects the net benefit variable. It shows that hypothesis 3, which is that system quality has a significant effect on net benefit, is accepted.

The information quality variable (X₂) obtained a positive t-count of 10,882 with a sig of 0.02 < 0.05. So, the information quality variable positively and significantly affects the net benefit variable. It shows that hypothesis 4, which is that information quality has a significant effect on net benefit, is accepted.

The service quality variable (X₃) obtained a positive t-count of 9,865 with a sig of 0.01 < 0.05. So, the service quality variable positively and significantly affects the net benefit variable. It shows that hypothesis 5, which is that service quality has a significant effect on net benefit, is accepted.

The user satisfaction (Y₁) obtained a positive t-count of 13,927 with a sig. of 0.000 < 0.05. So, the user satisfaction variable positively and significantly affects the net benefit variable. It shows that hypothesis 6, which is that user satisfaction has a significant effect on net benefit, is accepted.

Examination of the Impact of System Quality, Information Quality, and Service Quality on Net Benefits through User Satisfaction in the Performance of State Civil Apparatus in the Malang District Government

2. Path Analysis

Table 3 Path Analysis Results

Variable	Direct Effect	Indirect Effect	Total Effect	Information
System Quality (X ₁) – User Satisfaction (Y ₁) – Net Benefit (Y ₂)	0,702	0,242 x 0,857 = 0,207	0,702 + 0,207 = 0,909	Indirect effect < direct effect, 0,207 < 0,702
Information Quality (X ₂) – User Satisfaction (Y ₁) – Net Benefit (Y ₂)	0,775	0,945 x 0,857 = 0,809	0,775 + 0,809 = 1,584	Indirect effect > direct effect, 0,809 < 0,775
Service Quality (X ₃) – User Satisfaction (Y ₁) – Net Benefit (Y ₂)	0,763	0,258 x 0,857 = 0,221	0,763 + 0,221 = 0,984	Indirect effect < direct effect, 0,221 < 0,763

The indirect effect of system quality on the net benefit variable through the user satisfaction variable is 0.207 < direct effect 0.702. This means that the user satisfaction variable can become an imperfect mediating variable for the system quality variable on the net benefit variable.

The indirect effect of information quality on the net benefit variable through the user satisfaction variable is 0.809 > direct 0.775. This means that the user satisfaction variable can become a perfect mediating variable for the information quality variable on the net benefit variable.

The indirect effect of service quality on the net benefit variable through the user satisfaction variable is 0.221 < direct effect 0.763. This means that the user satisfaction variable can become an imperfect mediating variable for the service quality variable on the net benefit variable.

B. DISCUSSION

1. The Influence of System Quality on User Satisfaction

Based on the results of the research analysis, meaning that system quality, which includes availability, reliability, response time, and system usability, can foster satisfaction in system users. The results of this study related to system quality are in line with and strengthen the theory of the information system success model issued by DeLone and McLean (2003). System quality that has a significant effect on user satisfaction also strengthens previous research conducted by Hidayatullah, Khourouh, Windhyastiti, Patalo, and Waris, 2020, that system quality will increase user satisfaction. The study also strengthens previous research conducted by Utomo, Ardianto, and Sisharini, 2017, that system quality, information quality, and service quality together can contribute to user satisfaction.

2. The Influence of Information Quality on User Satisfaction

The results of this research analysis show that the quality of information has a significant effect on user satisfaction. The results of this study related to the quality of information are in line with and strengthen the theory of the information system success model issued by DeLone and McLean (2003). The quality of the system has a significant effect on user satisfaction. Also, it strengthens previous research conducted by Hidayatullah, Khourouh, Windhyastiti, Patalo, and Waris, 2020, that the more complete the information available, the easier it is to understand the features and the relevance or accuracy of the application, the higher the user satisfaction. The research also strengthens previous research conducted by Utomo, Ardianto, and Sisharini, 2017, that system quality, information quality, and service quality together can contribute to user satisfaction.

3. The Influence of Service Quality on User Satisfaction

Based on the results of the research analysis, the quality of service, which includes certainty, empathy, and responsiveness, can increase satisfaction in system users by 83%. The results of this study related to service quality are in line with and strengthen the theory of the information system success model issued by DeLone and McLean (2003). The quality of service has a significant effect on user satisfaction and also strengthens previous research conducted by Hidayatullah, Khourouh, Windhyastiti, Patalo, and Waris, 2020; that respondents have been satisfied with the use of the application, they also intend to use the application on another occasion. The study also strengthens previous research conducted by Utomo, Ardianto, and Sisharini, 2017, that system quality, information quality, and service quality together can contribute to user satisfaction.

Examination of the Impact of System Quality, Information Quality, and Service Quality on Net Benefits through User Satisfaction in the Performance of State Civil Apparatus in the Malang District Government

4. The Influence of System Quality on Net Benefit

The results of the research analysis calculation show that system quality has a significant effect on net benefits; this is in line with the expert theory entitled the information system success model issued by DeLone and McLean (2003). The author's research provides different results from the results of previous research conducted by Hidayatullah, Alvianna, Sugeha, and Astuti (2022), which showed that system quality does not directly have a significant effect on net benefits.

5. The Influence of Information Quality on Net Benefit

Based on the research results, the direct influence of information quality, which consists of completeness, ease of understanding, relevance, and security, has a significant effect on net benefits. The results of this study related to information quality are in line with and strengthen the theory of the information system success model issued by DeLone and McLean (2003). This study also strengthens the results of previous research conducted by Hidayatullah, Alvianna, Sugeha, and Astuti, 2022, showing that information quality directly has a significant effect on net benefits.

6. The Influence of Service Quality on Net Benefit

The results of the research analysis that has been carried out show the direct influence of service quality on net benefits. In line with the expert theory of the information system success model issued by DeLone and McLean (2003), the results of this study strengthen the expert theory. The results of this study also strengthen the results of previous research conducted by Hidayatullah, Alvianna, Sugeha, and Astuti, 2022, that service quality has a direct and significant effect on net benefits.

7. The Influence of User Satisfaction on Net Benefit

Based on the results of the research analysis, user satisfaction has a significant effect on net benefits. The results of this study related to user satisfaction are in line with and strengthen the theory of the information system success model issued by DeLone and McLean (2003). User satisfaction, which has a significant effect on net benefits, also strengthens previous research conducted by Hidayatullah, Khourouh, Windhyastiti, Patalo, and Waris, 2020, that existing applications have provided more benefits for respondents, are able to facilitate the transfer of knowledge and are able to accommodate 100 participants at one time at once. The study also strengthens previous research conducted by Utomo, Ardianto, and Sisharini, 2017, that system quality, information quality, and service quality together can contribute to user satisfaction.

8. The Influence of System Quality on Net Benefit Through User Satisfaction

Based on the research results, to measure the value of the indirect influence of system quality on net benefits through user satisfaction, it is necessary to calculate the total influence first. It can be concluded that the mediation effect of user satisfaction has an effective role in improving system quality and the net benefits of information system users. The results of this study strengthen the expert theory of the information system success model by DeLone and McLean (2003) and previous research conducted by Hidayatullah, Alvianna, Sugeha, and Astuti, 2022.

9. The Influence of Information Quality on Net Benefit Through User Satisfaction

Based on the research results, the total measurement between information quality and net benefit through user satisfaction has a value of 1.593. It ranks first from the other total influences, meaning that the quality of the information presented dominates the performance assessment information system. The value of the direct influence between information quality and net benefit shows a figure of 0.775. In contrast, the value of the indirect influence between information quality and net benefit through user satisfaction shows a figure of 0.818, so it can be concluded that the mediation effect of user satisfaction has an effective role in improving the quality of information on the net benefit of information system users. The results of this study strengthen the expert theory of the information system success model by DeLone and McLean (2003). Still, the results of this study are not in line with the results of previous research conducted by Hidayatullah, Alvianna, Sugeha, and Astuti, 2022, which shows that the quality of information on net benefits is not significant; this is indicated by a significance value of 0.057.

10. The Influence of Service Quality on Net Benefit Through User Satisfaction

Based on the research results, the total measurement between service quality and net benefit through user satisfaction has a value of 1.543 and is second place among other total influences. The value of the direct influence of service quality on net benefit is 0.763, while the value of the indirect influence between service quality and net benefit through user satisfaction is 0.780, so it can be concluded that the mediation effect of user satisfaction has an effective role in improving service quality on the net benefit of information system users. The results of this study strengthen the expert theory of the information system success model by DeLone and McLean (2003), but the results of this study are not in line with the results of previous research conducted by Hidayatullah, Alvianna, Sugeha, Astuti, 2022, which shows that the quality of information on net benefits is not significant, this is indicated by a significance value of 0.077.

Examination of the Impact of System Quality, Information Quality, and Service Quality on Net Benefits through User Satisfaction in the Performance of State Civil Apparatus in the Malang District Government

V. CONCLUSION

Based on the results of research on the examination of the impact of system quality, information quality, and service quality on net benefit through user satisfaction in the Performance of State Civil Apparatus in the Malang District Government, the following conclusions are drawn:

1. The quality of the system, consisting of indicators of availability, reliability, response time, and usability, is a variable that can grow user satisfaction because it is proven to have a significant influence. This condition can be interpreted as the state civil apparatus performance information system created and developed by the Malang Regency Government, which ASN can accept.
2. The quality of information consists of indicators of completeness, ease of understanding, relevance, and security, which are variables that have a significant influence on user satisfaction. It can be interpreted that the information presented in the state civil service performance information system is able to present accurate and quality information for ASN.
3. Service quality, consisting of indicators of certainty, empathy, and responsiveness, is a variable that can also grow user satisfaction, which is proven to significantly affect user satisfaction. This condition proves that the service carried out by the state civil service performance information system can serve ASN well in the Malang Regency Government environment.
4. User satisfaction, consisting of repeat visit indicators and user surveys, proves that user satisfaction brings net benefits and has a significant effect. This proves that the higher the level of ASN satisfaction in the Malang Regency Government environment towards the state civil apparatus performance information system, the more benefits it will bring to the ASN performance management process.
5. In this study, Net Benefit was measured using cost-saving and time-saving indicators. Based on the research results, respondents generally agreed that the performance information system was able to bring its own net benefits to ASN within the Malang Regency Government.
6. The results of the study of the mediation effect between independent variables consisting of system quality, information quality, and service quality with interfering variables, namely net benefit through user satisfaction, showed that the type of mediation was partial mediation. Path analysis resulted in findings that the mediation effect of user satisfaction variables had an effective role in increasing net benefits, so it can be concluded that the satisfaction of users of the state civil service performance information system needs to be maintained so that the information system can have a better impact on ASN in the Malang Regency Government environment.

REFERENCES

- 1) Brien, J. O., & Markas, G. (2011). Management Information System (Vol. 10th).
- 2) Davis, F. D., 1989. Perceived Ease of Use and User Acceptance of Information Technology. Management Information Systems Quality Journal Volume 13 No.3 p 319–340.
- 3) DeLone, W.H., & McLean, E.R. (2003). The DeLone and McLean model of information system success: A ten-year update. Journal of Management Information System. <http://doi.org/10.1080/07421222.2003.11045748>
- 4) Hidayatullah, S., Khourouh, U., Windhyastiti, I., Patalo, R.G., Waris, A. (2020.) Implementasi Model Kesuksesan Sistem Informasi DeLone & McLean Terhadap Sistem Pembelajaran Berbasis Aplikasi Zoom di Saat Pandemi Covid-19. Jurnal Teknologi dan Manajemen Informatika.
- 5) Hidayayullah, S., Alvianna, S., Sugeha, A.Z., Astuti, W. (2022). Penerapan Model Kesuksesan Sistem Informasi DeLone and McLean dalam Penggunaan Aplikasi Pedulilindungi pada Sektor Pariwisata Kota Malang.
- 6) Ichsan, M., Sujoko, S., Guntur M., Choirunnisa, W. (2017). Evaluasi Kesuksesan Implementasi OM SPAN Menggunakan Model DeLone dan McLean. Jurnal BPPK volume 10.
- 7) Irfan. (2019). Pengaruh Kualitas Sistem, Kualitas Informasi, dan Kualitas Pelayanan Terhadap Net Benefit Pemakaian BRIVA dengan Variabel Interfening Kepuasan Pengguna. Providing National Conference on Applied Business.
- 8) Kurniawan, I., Ardianto, Y.T., Hidayatullah, S. (2021). The Effect of System Information Quality, Service Quality, and User Satisfaction on Academic Information System User Loyalty. Internation Journal of Scientific & Technology Research Volume 10.
- 9) Respati, H., Hiidayatullah, S., (2017). Analisis Kualitas Sistem dan Kualitas Informasi Terhadap Kepuasan Pemakai Sistem Informasi Akademik Dosen. Seminar Nasional Sistem Informasi.
- 10) Sidharta, Lani. 1995. Pengantar Sistem Informasi Bisnis, P.T. ELEX Media Komputindo, Jakarta.

Examination of the Impact of System Quality, Information Quality, and Service Quality on Net Benefits through User Satisfaction in the Performance of State Civil Apparatus in the Malang District Government

- 11) Utomo, L.T., Ardianto, Y.T., Sisharini, N. (2017). Pengaruh Kualitas Sistem, Kualitas Informasi, Kualitas Layanan Terhadap Kepuasan Pengguna Sistem Informasi Akademik Universitas Merdeka Malang. *Jurnal Teknologi dan Manajemen Informatika*.
- 12) Wara, L.S., Kalangi, L., Gamaliel, H. (2021). Pengujian Model Kesuksesan Sistem Informasi DeLone dan McLean Pada Sistem Aplikasi Pemeriksaan (SIAP) di Badan Pemeriksa Keuangan Republik Indonesia Perwakilan Provinsi Sulawesi Utara. *Jurnal Riset Akuntansi dan Auditing "GOODWILL"*.
- 13) Whitten, J. L., & Bentley, L. D. (2007). *Systems Analysis and Design Methods*. New York: McGraw-Hill.

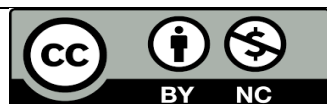

There is an Open Access article, distributed under the term of the Creative Commons Attribution – Non Commercial 4.0 International (CC BY-NC 4.0) (<https://creativecommons.org/licenses/by-nc/4.0/>), which permits remixing, adapting and building upon the work for non-commercial use, provided the original work is properly cited.

Legal Implications of the Cancellation of Document Copies by Court Ruling on Notarial Minutes



Ida Ayu Mira Pratiwi¹, I Nyoman Sujana², Ida Bagus Agung Putra Santika³

^{1,2,3} Warmadewa University & Terompong No.24, Sumerta Kelod, Denpasar, Bali 80239

ABSTRACT: Notaries, as public officials regulated by the Notary Law (UUJN) and the Amendment of Notary Law (UUJN-P), play a crucial role in the creation of authentic documents and have the authority to guarantee the legality of legal acts. However, the cancellation of document copies by the court raises significant legal implications for the status of notarial minutes, which need to be further analyzed to establish legal certainty in notarial practices in Indonesia. This research aims to provide a deeper understanding of the legal status of notarial minutes after their copies are canceled, as well as to offer recommendations regarding necessary regulations to create legal certainty in notarial practices in Indonesia. This study employs a normative or doctrinal research methodology with a normative legal approach to examine the relevant legal principles and written regulations concerning the legal implications of the cancellation of document copies on notarial minutes. It utilizes primary, secondary, and tertiary legal materials as sources, along with data collection techniques through literature studies and document analysis. The findings of this research indicate that the cancellation of document copies by the court renders the notarial minutes as informal documents or null and void due to the failure to meet legal requirements. Parties who disagree can file a lawsuit in court; notaries who do not withdraw the minutes risk becoming involved in legal issues and may be held civilly liable if found to have acted unlawfully, while criminal penalties may apply if false information is present in the documents.

KEYWORDS: Deed, Minutes, Notary

I. INTRODUCTION

Notaries, as public officials, play a crucial role in the creation of authentic documents, regulated by Law Number 30 of 2004 on Notary Positions (UUJN) and Law Number 02 of 2014, which amends the UUJN (UUJN-P). Article 1, paragraph 1 of UUJN-P defines a Notary as an official authorized to create authentic documents and possesses other authorities. Thus, Notaries not only function as creators of official documents but also as parties that guarantee the legality and legal certainty of the legal acts performed by the public

The authority of Notaries includes the creation of authentic documents concerning all acts and agreements required by law or requested by the interested parties. Additionally, Notaries are also permitted to authenticate signatures, create copies of documents, provide legal counseling, and draft documents related to land and auction minutes. Based on their expertise and specialized education, Notaries carry out their duties to ensure legal certainty and protect the rights of the parties involved (Adjie, 2006).

In practice, the documents produced by Notaries do not always function as perfect authentic documents. There is a possibility of cancellation of the document, either through an agreement of the parties involved or through a court ruling. This cancellation may occur due to disputes, non-compliance with the contents of the document, or an agreement to terminate the legal relationship regulated in the document. The dispute resolution process can be carried out through non-litigation methods, such as mediation or arbitration, or through litigation in court (Rosita, 2024).

The cancellation of a notarial document brings significant legal implications, especially concerning the status of the notarial minutes and the document copies. The notarial minutes are the original documents that include the signatures of the parties and are kept as part of the Notary's protocol, while the document copies are accurate reproductions of the original document. In this

Legal Implications of the Cancellation of Document Copies by Court Ruling on Notarial Minutes

context, questions arise regarding the status of the notarial minutes when the document copies are canceled based on a court ruling, considering that both types of documents serve as valid authentic evidence (Djameswar, 2020).

Based on the existing provisions, there are no clear regulations regarding the legal status of notarial minutes after the cancellation of the document copies. This creates legal uncertainty that needs to be further analyzed. The author is interested in examining 'Legal Implications of the Cancellation of Document Copies by Court Ruling on Notarial Minutes'. This research aims to provide a deeper understanding of the legal status of notarial minutes after their copies are canceled, as well as to offer recommendations regarding the necessary regulations to create legal certainty in notarial practices in Indonesia.

II. RESEARCH METHODS

This research methodology adopts a normative research type, which aims to examine legal principles and investigate the relevant written regulations regarding the legal implications of the cancellation of document copies on notarial minutes. This research is also known as doctrinal research, where the main focus is on what is written in statutory regulations (law in books) as well as the rules or norms that serve as guidelines for human behavior considered appropriate. In this case, the approach used is a normative legal approach, which involves document and literature studies, as well as opinions from experts related to Law Number 30 of 2004 and Law Number 2 of 2014 concerning notary positions. This research reflects the importance of notaries as positions of trust that have the obligation to maintain confidentiality in carrying out their duties and produce documents of an authentic nature (Soekanto, 2013).

The legal materials used in this research consist of primary, secondary, and tertiary legal sources. Primary legal materials include statutory regulations such as the Civil Code and the Law on Notary Positions, as well as other relevant documents. Secondary legal materials encompass reference books that discuss related themes, such as agreements, obligations, and taxes. Tertiary legal materials provide additional explanations, including legal dictionaries and other sources of information. The technique for collecting legal materials is conducted through literature studies, where the researcher gathers and analyzes legal materials by interpreting the law normatively and formulating statements based on the consistency of information obtained from various sources (Amiruddin, 2006).

III. RESULT AND DISCUSSION

LEGAL CONSEQUENCES OF MINUTA DEEDS WHICH COPY IS CANCELED BY THE COURT

A. Regulation of Notary's Authority in Making Copies of Deeds

Notaries, as public officials recognized for their high integrity, have a significant responsibility in the creation of authentic documents regulated by the Law on Notary Positions (UUJN). As an extension of the state, Notaries are authorized to create legal documents that are binding and meet public interests (Soegondo, 2001). Authentic documents, in accordance with Article 1868 of the Civil Code, have full evidentiary power, thus their validity greatly depends on the Notary's adherence to legal provisions. The duties of a Notary are not limited to the creation of documents but also include additional authorities such as the authentication of signatures and the establishment of the date certainty of letters, all of which provide guarantees of the legality of the documents produced (Soemoatmodjo, 2000).

However, the authority of Notaries is also regulated by various requirements and limitations to maintain the integrity of their profession. According to G.H.S. Lumban Tobing, Notaries are prohibited from creating documents for their personal or family interests, as this could diminish the status of the document as an authentic one (Tobing, 1991). Additionally, the prohibition against Notaries holding concurrent positions in other institutions aims to prevent conflicts of interest that could harm the public. With these strict regulations, it is expected that Notaries can perform their duties objectively and professionally while upholding the dignity of their position (Adjie, 2009).

In practice, Notaries produce two types of documents, namely the minutes of the act and the copies of the act, which are kept in an official protocol. This protocol is an important state archive that must be well-maintained, encompassing various documents that can be used for legal proof in the future. Notaries are also required to report the list of acts they create to the Regional Supervisory Council (DPD) to maintain transparency and accountability (Andriansyah, 2018). Furthermore, in a legal context, Notaries may be called upon to provide testimony as witnesses, demonstrating their important role in law enforcement and the legitimacy of the acts they create.

Legal Implications of the Cancellation of Document Copies by Court Ruling on Notarial Minutes

B. Cancellation of Notarial Deed

The cancellation of a notarial act occurs when an agreement is declared null and void. There are two types of cancellation: absolute and relative. Absolute cancellation applies without the need for a request from a specific party if objective requirements, such as legal or moral provisions, are violated, rendering the agreement as if it never existed and not binding on anyone. For example, if an agreement that is required to be made through a Notary is not executed, that agreement is void by law. On the other hand, relative cancellation occurs if subjective requirements are not met and can be annulled at the request of an interested party, such as a guardian or parent (Adjie, 2017).

Cancellation Due to Agreement

The cancellation of an agreement according to the Indonesian Civil Code (KUHPperdata) can nullify an obligation if requested by the aggrieved party. Article 1381 of the Civil Code lists 10 ways to terminate an obligation, including cancellation, which applies if an agreement violates subjective or objective validity requirements. Subjective requirements are breached if there is a defect of will, such as error, coercion, or incapacity; whereas objective requirements are violated if the agreement contradicts law, public order, or morality, making the agreement void by law. Cancellation can also be mutually agreed upon by both parties, such as through settlement or compensation.

Cancellation Due to Court Decision

The cancellation of an agreement through a court ruling can be achieved via mediation or a judicial decision. In court-ordered mediation, a peaceful settlement is documented in an *acta van dading*, a reconciliation document endorsed by the judge in accordance with Indonesian Supreme Court Regulation No. 1 of 2016, aimed at enhancing public access to justice efficiently. Additionally, a judge may annul a notarial deed if evidence shows that a party was harmed. Under Law No. 48 of 2009 on Judicial Power, judges are required to specify the legal basis for each decision, including relevant statutory articles, jurisprudence, or legal doctrines.

C. Factors Causing the Cancellation of a Notarial Deed

1. Cancellation Due to Civil Events

Agreement cancellation can arise from civil events such as wanprestasi (non-fulfillment of obligations) and unlawful acts. Wanprestasi, as regulated by Article 1243 of the Indonesian Civil Code, occurs when a debtor fails to fulfill their obligations, which may result in liability for compensation (Wardhani, 2017). While wanprestasi does not automatically void an agreement, the aggrieved party may seek cancellation through the court. Article 1266 of the Civil Code includes conditions for contract termination to address this possibility (Khairandy, 2014). Conversely, an unlawful act, outlined in Article 1365, involves actions that breach the law and cause harm, where the responsible party may face compensation obligations. This application of liability aims to protect the rights of individuals who suffer losses (Agustina, 2012).

2. Cancellation Due to Criminal Events

The imposition of a criminal penalty on a Notary does not automatically invalidate a Notarial deed by law. If there is a civil lawsuit to cancel the deed and the Notary has been convicted, any testimony must still adhere to applicable legal provisions. Criminal sanctions apply to individuals acting unlawfully and are condemnatory, in accordance with the Notary Office Act (UUJN) and the Law on Notary Positions (UUJNP), though not detailed explicitly in these regulations. In cases of violations, the Notary is prosecuted under general criminal procedures, with penalties set through a legally binding court ruling (Whardhani, 2017).

3. Cancellation Due to Administrative Events

A Notarial deed is considered the strongest form of evidence, possessing perfect evidentiary power; however, violations of legal provisions in its creation can result in the deed losing its authenticity, reducing it to the status of a private document. If a deed is void, all legal actions it regulates are also nullified, particularly when an authentic deed is required by regulation. However, if authenticity is not mandatory for the deed, both the deed and the legal actions outlined within it remain valid, as long as they reflect the parties' intentions. Conversely, if the agreement requirements are unmet or there is a defect in the subject matter of the agreement, the deed is considered null, such as in cases involving land sales based on falsified evidence (Erliyani, 2020).

D. Legal Consequences of Copies of Deeds Cancelled by the Court

In Article 1 point 1 of Law Number 2 of 2014 concerning Amendments to Law Number 30 of 2004 on the Position of Notary (UUJN), a Notary is defined as a public official authorized to make authentic deeds and hold other authorities as stipulated in the law or based on other statutory regulations. As an official appointed by the government, the Notary is responsible for meeting the public's needs for legal documents with binding legal force, in a passive role, waiting for individuals to come seeking their services.

Legal Implications of the Cancellation of Document Copies by Court Ruling on Notarial Minutes

"A Notary is a public official authorized to create authentic deeds and other authorities as referred to in this law."

Furthermore, the explanation of the UUJN states that a notary is a public official authorized to create authentic deeds, provided the creation of such deeds is not specifically designated for another official. The term "Notary" refers to an official with duties related to public interest, categorizing them as public officials who serve the needs of the community.

Notary's Authority

The duties and authority of notaries are regulated in Article 1, paragraph 1 of the UUJN, which includes the creation of authentic deeds and other authorities as stipulated in the UUJN. According to Article 15, paragraph (1) of the UUJN, notaries are authorized to (Adjie, 2009):

1. Create authentic deeds regarding all actions, agreements, and provisions that are required by laws or desired by the interested parties.
2. Ensure the certainty of the date of the deed's creation, keep the deeds, and provide copies and excerpts of the deeds, as long as the creation of the deeds is not assigned to another official or person designated by law.

In addition, Article 15 paragraph (2) of the UUJN provides additional authority to notaries to:

1. Authenticate signatures and establish the certainty of dates for private documents through registration in a special book.
2. Record private documents in a special book.
3. Create copies of private documents.
4. Certify the conformity of photocopies with the original documents.
5. Provide legal counseling related to the creation of deeds.
6. Create deeds related to land matters.
7. Create auction minutes.

Definition of Authentic Deed

In Indonesian civil law, there are two types of deeds: authentic deeds and private deeds. Authentic deeds, which are created by a notary, have higher legal force compared to private deeds, which do not possess the same formalities.

Some definitions of authentic deeds from legal experts include:

1. **Subekti:** "A document that is intentionally created to serve as evidence of an event and is signed."
2. **M. Abdurrachman:** "A letter that is intentionally created and signed to serve as evidence of an event."
3. **R. Tresna:** "A letter that is signed and contains information about events or matters that serve as the basis for a right or agreement."

The official definition of an authentic deed is also stated in Article 1868 of the Civil Code, which states that an authentic deed is: "An act that is made in the form prescribed by law by or before an authorized public official at the place where the act is executed."

The elements that must be fulfilled for a deed to be considered an authentic deed include:

1. The form and composition are determined by law.
2. Made before an authorized public official.
3. Has a recognized legal standing.

Copy of Deed

Notaries are obligated to create and provide copies of acts that have enforcement power, commonly referred to as the grosse act, excerpts of the act, or copies of the act. According to the Notary Law (UUJN-P) Article 1, number (9), a copy of an act is:

"A verbatim copy of the entire Act, and at the bottom of the copy of the Act, the phrase 'issued as a copy with the same wording' is stated."

However, both the UUJN and UUJNP do not regulate the cancellation of acts and the notary's obligation to withdraw copies of acts, resulting in a legal vacuum that creates uncertainty.

Cancellation of Deed

When a dispute arises concerning an act, and if that act is declared null and void by the court, the legal consequences will affect all copies of the act that have been issued. The notary, as the maker of the act, must pay attention to the validity of the agreement and the essential requirements for a valid agreement as stipulated in Article 1320 of the Civil Code, which are:

1. The agreement of those who bind themselves.
2. The ability to make a contract.
3. A certain thing.
4. A lawful cause.

Legal Implications of the Cancellation of Document Copies by Court Ruling on Notarial Minutes

If these requirements are not met, the agreement may be requested to be annulled. In practice, when the parties agree to cancel the act that has been made, the steps taken must comply with the applicable legal provisions, including regarding the impact on copies of the act that already exist.

LEGAL CONSEQUENCES OF MINUTA DEEDS WHICH COPY IS CANCELLED BY THE COURT

A. Characteristics of Authentic Notarial Deeds

Notarial authentic acts are official documents that possess high evidentiary power and are created by authorized officials, such as notaries, Land Deed Officials (PPAT), or other officials in accordance with applicable regulations. These authentic acts are structured in forms and formats determined by law, making them valid and irrefutable evidence. The main difference between authentic acts and private deeds lies in their creation; private deeds are made without involving public officials and do not adhere to strict legal provisions. In terms of evidentiary strength, authentic acts hold greater power due to their regulated content and format, while private deeds only have evidentiary force that can be upheld if recognized by the parties involved. Both authentic acts and private deeds aim to provide valid proof for transactions or agreements made between parties (Khairandy, 2014).

The structure of a notarial deed consists of three main parts: the head of the deed, the body of the deed, and the closing of the deed, each serving different functions and containing distinct information. The head of the deed includes information about the notary who created the deed, as well as the identities of the parties present at the time the deed was made. This section also states the title of the deed, deed number, time, day, month, year, and the location of the notary's office. The body of the deed contains further details about the contents of the agreement made, including the statements provided by the parties or declarations witnessed by the notary. Finally, the closing of the deed includes information about the time and place the deed was signed, details regarding witnesses, and confirmation that the deed has been read and signed by all parties involved. The overall structure aims to provide clarity, validity, and legal certainty for all parties involved in the agreement (Adjie, 2013).

The importance of subjective and objective requirements in the creation of a notarial deed cannot be overlooked, as both determine the validity of an agreement. The subjective requirements relate to the legal capacity of the parties to enter into an agreement, which includes the existence of mutual consent and the ability to act legally. On the other hand, the objective requirements encompass the subject matter of the agreement, which must be specific, and the purpose of the agreement, which must not contravene the law, morality, or public order. If either of these requirements is not fulfilled, the agreement may be annulled. For example, if an agreement that is required to be executed in the form of a notarial deed is not done, the agreement is considered null and void, meaning it is regarded as if it never existed and has no legal effect. Therefore, a notarial deed not only serves as evidence but also acts as a guarantee of legal certainty that protects the rights and obligations of the parties involved in the transaction.

B. Formal and Material Requirements for Making an Authentic Deed

An authentic deed is an official document created by or in the presence of a notary, and the presence of the notary as the authorized party in the creation of this deed is crucial to ensure that the deed meets the legal requirements outlined in Article 1868 of the Civil Code (KUHPerdata). These requirements include the agreement between the parties involved, the legal capacity to perform legal acts, a clear subject matter of the agreement, and the existence of lawful authority. If any of these conditions are not fulfilled, the deed cannot be considered authentic and will only have the force of a private writing. This underscores the importance of adhering to the established procedures to ensure that the deed has valid legal force (Victor, 1993).

The advantages of an authentic deed lie in its perfect evidentiary power, where this deed can stand alone without requiring additional evidence, unless there is contrary proof. Additionally, an authentic deed must meet both formal and material requirements, with formal requirements encompassing information that must be included in the deed, such as the identities of the parties, the time and place of creation, and the witnesses present. During the creation process, the notary is responsible for ensuring that all information and procedures are correctly followed, allowing the authentic deed to serve as a strong and reliable piece of evidence in the legal context (Sugeng, 2012).

In practice, the creation of an authentic deed requires meticulousness and caution to maintain the validity and legal strength of the deed. This deed plays a crucial role in providing legal certainty for the parties involved in an agreement, as well as helping to prevent legal disputes in the future. Therefore, a deep understanding of the requirements that must be met in the creation of an authentic deed is essential for notaries and other legal practitioners, ensuring that the resulting documents are reliable and recognized within the legal system.

Legal Implications of the Cancellation of Document Copies by Court Ruling on Notarial Minutes

C. Notary's Responsibility for Deeds Canceled by the Court

The notary's responsibility regarding deeds that have been annulled by the court encompasses various aspects, especially concerning the material and formal truth of the deed. The terms 'nullity' and 'annulment' in contract law refer to situations where a contract lacks legal consequences, either due to the failure to meet objective or subjective requirements. Nullity by law means that the deed has no legal consequences from the moment it is made, while annulment depends on the decision of certain parties. The notary is responsible for the accuracy of the contents of the deed made in their presence, and if there are mistakes, they may be subject to civil or criminal liability. This responsibility includes the obligation to ensure that all formal and material requirements have been fulfilled, as well as maintaining the integrity and confidentiality of the information from the parties involved. If the deed is contested, the parties may request the annulment of the deed or sue to change the status of the deed to that of a private document. In situations where one party feels aggrieved, they can file a lawsuit for damages against the notary if they can prove that the loss was a direct result of an error in the deed (Sudiko, 2005).

Civil Liability of Notaries

The notary's civil responsibility for the material truth of the deeds they create is based on the unlawful act framework as outlined in Article 1365 of the Civil Code, which includes both active and passive actions that may cause harm to others. The elements that constitute an unlawful act include the existence of actions that violate the law, fault, and loss. In the context of a notary, their responsibility is more focused on the formalities of authentic deeds rather than the substantive content of the deed itself. Notaries are expected to act neutrally and provide accurate legal advice; if that advice is incorrect and misleads one of the parties, the notary can be held accountable for any resulting losses. Therefore, a notary has an obligation to provide clear and accurate access to information regarding the law related to the deeds they create, ensuring that the parties are not harmed due to their ignorance (Yuana, 2010).

Criminal Liability of Notaries

The criminal responsibility of a notary is related to actions that violate the law as regulated in the Penal Code (KUHP), even though specific criminal provisions are not explicitly outlined in the Notary Act. A notary or land deed official (PPAT) can face criminal sanctions for acts such as creating or using false documents (Article 263 KUHP), forgery (Article 264 KUHP), or instructing the inclusion of false information in an authentic deed (Article 266 KUHP). Administrative sanctions for notaries/PPATs may range from warnings to dismissal without honor. In criminal cases, the element of fault must be present, whether intentional (*opzet*) or negligent (*culpa*); intent can involve a specific purpose, awareness of certain consequences, or knowledge that consequences may occur. Additionally, for criminal responsibility to be applied, the act must fulfill three elements: the prohibited act, the consequence that justifies the prohibition, and the legal violation (Wirjono, 2011).

Notary's Administrative Responsibilities

The administrative responsibility of a notary is closely related to the Notary Act and the professional Code of Ethics, which require notaries or land deed officials (PPAT) to draft deeds properly and accurately, fulfill the requests of interested parties, and produce quality deeds in accordance with the law. Notaries are also obliged to explain the truth of the content and procedures of the deeds to the involved parties and ensure that the deeds have perfect evidential power. Regarding formal aspects, notaries must pay attention to the certainty of dates, the identities of the parties present, and the consistency of the deed copies with the minute. Sanctions for notaries who violate these provisions can range from warnings to dismissal, in accordance with Article 85 of the Notary Act. Furthermore, notaries are required to follow up on the annulment of deeds by the court by issuing a cancellation deed and keeping it in the notary's protocol, which serves as an archive and valid evidence. The minutes of the deed, whether related to annulment or annulled, are an essential part of the notary's protocol, protecting the interests of all parties and supporting the enforcement of law in the future (Ansori, 2009).

IV. CONCLUSION

The legal consequences of a deed minute whose copy has been annulled by the court result in the deed losing its evidential power and being considered null and void due to non-compliance with the requirements established in regulations. In cases of dispute without an agreement on the annulment, the party unwilling to be bound can file a lawsuit in court. If the notary fails to withdraw the minute of the deed whose copy has been annulled, they risk becoming involved in legal issues, including the possibility of being considered complicit in unlawful actions (Article 266 of the Penal Code) if the annulled copy is used as a basis for action. The notary's responsibility regarding the annulled deed is civil in nature, meaning the notary may face a damages claim if it is proven they committed an unlawful act in accordance with Article 1365 of the Civil Code. However, if one party breaches the agreement

Legal Implications of the Cancellation of Document Copies by Court Ruling on Notarial Minutes

and the notary has fulfilled the requirements for the deed's creation, the notary is not liable for the deed's annulment. On the other hand, if the annulment is due to the notary's negligence, both criminal and civil sanctions may be imposed. The criminal sanctions are not specified in the Notary Act but can refer to the Penal Code, while civil sanctions would involve compensation to the aggrieved party.

Authentic deeds produced by Notaries/PPATs possess perfect evidential strength, and thus to maintain their authenticity, Notaries/PPATs must adhere to established rules and uphold their oath and the dignity of their profession. Article 16 paragraph (1) letter a of the Notary Act emphasizes that Notaries must act with diligence and safeguard the interests of the parties involved in legal actions. Therefore, Notaries should conduct a thorough review of all information included in the deed prior to its signing. Additionally, the public should exercise caution and vigilance when engaging in legal actions to prevent losses that may arise from inaccurate deeds.

ACKNOWLEDGMENT

With great gratitude, the Author would like to thank all parties who have provided support and assistance in the preparation of this work, especially the lecturers, colleagues, and family who have provided motivation and inspiration, so that the Author can complete this research well.

REFERENCES

- 1) Adjie, H. (2009). Sanksi perdata dan administratif terhadap notaris sebagai pejabat publik (2nd ed.). Bandung: Refika Aditama.
- 2) Adjie, H. (2013). Kebatalan dan pembatalan akta notaris. Bandung: PT. Refika Aditama.
- 3) Amiruddin, & Asikin, H. Z. (2006). Pengantar metode penelitian hukum. Jakarta: Raja Grafindo Persada.
- 4) Andriansyah, R., et al. (2018). Tanggung jawab hukum notaris terhadap akta yang dibuatnya setelah berakhir masa jabatannya ditinjau dari Pasal 56 Undang-Undang Jabatan Notaris. *Jurnal Ilmiah Hukum Kenotariatan*, 22.
- 5) Anshori, A. G. (2009). Lembaga kenotariatan Indonesia: Perspektif hukum dan etika. Yogyakarta: UII Press.
- 6) Djameswar, K. R. S. (2020). Bentuk dan substansi cacat yuridis akta pejabat pembuat akta tanah kajian dalam perspektif kebatalan dan degradasi kekuatan bukti (Studi Putusan Pengadilan Negeri Denpasar Nomor 92/Pdt.G/2018/PN.Dps). *Indonesian Notary*, 2(1), 343.
- 7) Habib, A. (2006). Hukum Notaris Indonesia. Jakarta: Erlangga.
- 8) Khairandy, R. (2014). Hukum kontrak Indonesia dalam perspektif perbandingan (Bagian Pertama). Yogyakarta: FH UII Press.
- 9) Lumban Tobing, G. H. L. M. S. (1991). Pengaturan jabatan notaris. Jakarta: Erlangga.
- 10) Mertokusumo, S. (2005). Mengenal hukum (suatu pengantar). Yogyakarta: Liberty.
- 11) Notodisoerjo, R. S. (2001). Hukum notariat di Indonesia: Suatu penjelasan. Jakarta: Raja Grafindo Persada.
- 12) Rosita. (n.d.). Al-Bayyinah: Journal of Islamic Law, 2, 99–113. Retrieved August 27, 2024, from jurnal.lain-bone.ac.id
- 13) Soekanto, S., & Mamuji, S. (2013). Penelitian hukum normatif: Suatu tinjauan singkat. Jakarta: Raja Grafindo Persada.
- 14) Soemoatmodjo, S. (2000). Apakah notaris, PPAT, pejabat lelang. Yogyakarta: Liberty.
- 15) Sugeng A. S., B., & Sujayadi. (2012). Pengantar hukum acara perdata dan contoh dokumen litigasi. Jakarta: Kencana.
- 16) Wardhani, L. C. (2017). Tanggung jawab notaris/PPAT terhadap akta yang dibatalkan oleh pengadilan. Universitas Islam Indonesia. <https://doi.org/10.20885/JLR.vol2.iss1.art4>
- 17) Yuana, I. E. (2010). Tanggung jawab notaris setelah berakhir masa jabatannya terhadap akta yang dibuatnya ditinjau dari Undang-Undang Nomor 30 Tahun 2004 tentang Jabatan Notaris. Magister Kenotariatan Universitas Diponegoro Semarang.



There is an Open Access article, distributed under the term of the Creative Commons Attribution – Non Commercial 4.0 International (CC BY-NC 4.0) (<https://creativecommons.org/licenses/by-nc/4.0/>), which permits remixing, adapting and building upon the work for non-commercial use, provided the original work is properly cited.

Applicability of Fibonacci Series on Low Beta Stocks of Nifty-50



Veerendra Anchan¹, Vansh Shah², Vatsal Desai³, Rushabh Shah⁴

¹Assistant Professor, Anil Surendra Modi School of Commerce, NMIMS University, Mumbai

^{2,3,4}Student, MSc. (Finance), Anil Surendra Modi School of Commerce, NMIMS University, Mumbai

ABSTRACT: This study explores the relationship between stock volatility, measured by beta & price movement patterns using the Fibonacci series in the context of low beta stocks. Low beta stocks, typically more stable than high beta ones, were analyzed using Fibonacci retracement & extension levels to identify key support & resistance points. Historical price data from Nifty 50 low beta were examined under various market conditions including bullish, bearish & stable. The findings from our research indicate that the low beta stocks adhere to Fibonacci levels, hence it offers reliable long-term guidance. The study highlights that while Fibonacci retracement levels are useful, their effectiveness depends on stock volatility & market conditions, which helps investors in optimizing their trading strategies.

KEYWORDS: Stocks, Low beta, volatility, Fibonacci retracement levels, support & resistance.

INTRODUCTION

The Fibonacci series is a mathematical sequence renowned for its natural order & harmonic proportions. Each number in the series is the sum of 2 numbers that precedes it (e.g., 0,1,1,2,3,5,8,13 and so on). The arrangement of leaves, the spiral of shells & the growth of plants are examples of this pattern as commonly seen in nature. Because of its aesthetic balance & proportionality, this pattern has also been used in humanmade structures such as art & architecture. Fibonacci series' extensive applicability across numerous domains like biology, art & others highlights its versatility. In financial analysis, the Fibonacci sequence is often used as a tool for predicting stock movements, particularly in technical analysis (Lahutta, n.d.). Fibonacci retracements & extension levels are often used by traders as well as analysts to predict zones where stock prices are likely to reverse. The applicability of the Fibonacci sequence to low beta securities in the Nifty 50 index is researched in this study. Risk averse investors find low beta stocks attractive, especially during times of market turmoil & instability because of their relatively greater resistance to general market volatility. Despite the greater stability, these stocks are nevertheless susceptible to general market tendencies & investor sentiments of-course. This research aims to assess whether Fibonacci retracement levels can accurately forecast price support & resistance points, trend reversals & future price movements in the selected stocks. These levels are derived from key Fibonacci ratios such as 23.6%, 38.2%, 50%, 61.8% and so on which are believed to reflect areas where market sentiment may shift, either stopping or boosting the price momentum. By focusing on low beta stocks, the research takes a distinctive approach, exploring the effectiveness of this mathematical tool in a market segment that generally experiences more subdued price fluctuations. This raises the question of whether the Fibonacci series, traditionally applied to more volatile securities, can offer meaningful insights into the price behavior of relatively stable stocks. The study first reviews existing literature on the use of the Fibonacci series in the stock market analysis, emphasizing its role in technical analysis & its historical success in predicting price behavior. Following this, it applies Fibonacci retracement & extension principles to a set of low beta stocks selected from the Nifty 50 index. By doing so, the research aims to provide investors & market participants with valuable insights to optimize portfolio strategies & enhance decision making processes, particularly in uncertain market conditions which may enable investors to enhance returns while minimizing exposure to volatility. The results will reveal whether mathematical constructs such as the Fibonacci series can offer practical guidance in analyzing & trading low beta stocks. Ultimately, the study aims to bridge the gap between mathematical theory & practical investment strategies, showing how tools like the Fibonacci series can be leveraged, not just for high risk, volatile stocks but also for the more conservative, low risk securities of the market.

Applicability of Fibonacci Series on Low Beta Stocks of Nifty-50

LITERATURE REVIEW

In finance, Fibonacci tools are essential for analyzing market movements and identifying key price levels. Fibonacci retracement levels, which are based on ratios such as 23.6%, 38.2%, 50%, 61.8%, and 76.4%, assist traders in locating potential support and resistance zones within a price trend (Dikici & Özkan, 2003). These levels are calculated by applying these percentages to the vertical distance between a significant high and low on a chart, helping to predict where price corrections might occur. Fibonacci extensions, on the other hand, are used to estimate price targets beyond the initial high or low by extending the same ratios. Common extension levels include 161.8%, 261.8%, and 423.6%, providing insights into where the price might head following a retracement. Fibonacci arcs and fans offer more dynamic visualizations, with arcs creating curved lines based on Fibonacci ratios to highlight potential support and resistance, and fans using diagonal lines extending from a key price point to project these zones. Additionally, Fibonacci time zones apply Fibonacci ratios to time intervals rather than price levels, helping traders forecast potential turning points and significant price changes based on the timing of past market movements (Sinha, 2017). These tools, used individually or in combination, enable traders to make informed decisions about market entry, exit points, and risk management.

High Beta Stocks: These stocks have a beta greater than 1, indicating higher volatility compared to the broader market; they tend to experience larger price swings and are more sensitive to market movements. Investors often use high beta stocks for potential higher returns, albeit with increased risk.

Low Beta Stocks: These stocks have a beta less than 1, reflecting lower volatility and smaller price swings relative to the market; they are generally more stable and less sensitive to market fluctuations. Investors typically choose low beta stocks for stability and reduced risk. In the case of low beta or risk, if the volatility of the stock is lower, it could be possible that the support and resistance frequencies will be lower.

Our research gap lies in the application of Fibonacci retracement levels specifically to low beta stocks. While Fibonacci retracements have been studied in the context of high beta stocks, their effectiveness and predictive power for low beta stocks underexplored. By analyzing how Fibonacci retracement levels impact and correlate with the price movements of low beta stocks, our research aims to unravel interesting findings into the relative efficacy of these tools across different volatility profiles and provide a more comprehensive understanding of their utility in diverse market conditions.

RESEARCH METHODOLOGY

In this study, we aim to compare the performance and low beta stocks using the Fibonacci series as a tool for technical analysis. The data utilized in this research is composed of two main components: stock market data (low beta stocks) and the Fibonacci sequence applied in financial analysis. Historical stock market data for low beta stocks is collected from reputable financial databases such as Investing.com & the Economic Times. It comprises data of Nifty-50 as well as of a few companies forming a part of the aforementioned index. This data spans over a period of 10 years (e.g., from October 2014 to September 2024) to capture multiple market cycles and ensure the robustness of the results. Fibonacci retracement levels are calculated and used to assess price movements in stocks. These levels are generated from the Fibonacci sequence (e.g., 23.6%, 38.2%, 50%, 61.8%, and 100%) and applied to identify support and resistance levels in stock prices.

Fibonacci Retracement Levels: Calculated for each stock based on the highest and lowest prices observed during the study period.

Fibonacci Ratios: Percentage levels derived from the Fibonacci sequence used to analyze price trends. The Golden Ratio, often denoted by the Greek letter ϕ (phi), is an irrational number approximately equal to 1.6180339887. It has a deep connection with patterns in nature, geometry, and is frequently seen in art, architecture, and financial markets. The Golden Ratio occurs when a line segment is divided into two parts such that: The ratio of the entire length to the longer part is the same as the ratio of the longer part to the shorter part. In mathematical terms, if a segment is divided into a longer part "a" and a shorter part "b," then the Golden Ratio is defined as

$$\frac{a}{b} = \frac{a+b}{a}$$

Figure 1: Golden Ratio of Fibonacci

This relationship can be simplified to the quadratic equation:

$$\phi^2 - \phi - 1 = 0 \dots \dots \dots (1)$$

Solving this equation gives the value of ϕ :

$$\phi = \frac{1 + \sqrt{5}}{2} \approx 1.6180339887$$

Applicability of Fibonacci Series on Low Beta Stocks of Nifty-50

In this study, a regression test is used to investigate the relationship between high-beta and low-beta stocks, incorporating the Fibonacci series as a tool to compare their performance over time. Beta, a measure of a stock's volatility in relation to the market, categorizes stocks into high-beta (more volatile) and low-beta (less volatile) groups. The Fibonacci sequence is used to forecast potential support and resistance levels for both categories.

Independent Variable: In this research paper, the independent variable is Fibonacci retracement, which is used to identify potential reversal levels in stock price movements. When applied to the stock market, the employment of the Fibonacci sequence is tied to coefficients. These coefficients are utilized to define proper formations associated with the golden ratio (Majumdar, 2023b).

Dependent Variable: The dependent variable is stock price, which will be analyzed in low-beta stocks to observe how they behave in relation to Fibonacci retracement levels.

Table 1: Exponents of Fibonacci coefficients

Exponent	Fibonacci coefficient
-3	0.236 (23.6%)
-2	0.382 (38.2%)
-1.44	0.5 (50%)
-1	0.618 (61.8%)
-0.5	0.786 (78.6%)
1	1.618 (161.8%)
2	2.618 (261.8%)
3	4.236 (423.6%)

	Coefficient		Standard Error		T-stat	p-value
	b	a	b	a		
Nifty-50	7.79E-0.5	-2.77412	1.17E-05	0.466708	6.67247	0.000549
TCS	0.000479	-2.79251	7.17E-05	0.468952	6.672457	0.000549
Wipro	0.004235	-3.05182	0.000642	0.506618	6.597546	0.000583
HCL Tech	0.00095	-2.4954	0.000142	0.433433	6.672461	0.000549
Infosys	0.000933	-2.58173	0.00014	0.443585	6.672467	0.000549
Dr. Reddy's Labs	0.000356	-3.17399	5.34E-05	0.516607	6.672469	0.000549

Figure 7: Regression results

REGRESSION ANALYSIS

As we can observe in figure 7, all p-values are exceptionally small indicating that the results are highly significant. Therefore, the relationship between Fibonacci retracement levels & stock returns are statistically robust. In our reference research paper, we saw that most of the high beta stocks has 'b' coefficient as negative. However, this is not the case here. 'b' coefficient values are positive which shows that low beta stocks experience less dramatic reactions to retracement levels as they are less volatile & respond differently to market signals. Despite being from different sectors like IT & Pharma, the results are remarkably consistent across the board. All stocks show a positive "b" coefficient & highly significant p values suggesting that Fibonacci Retracement levels are effective in predicting return patterns for stable, low beta stocks.

Applicability of Fibonacci Series on Low Beta Stocks of Nifty-50

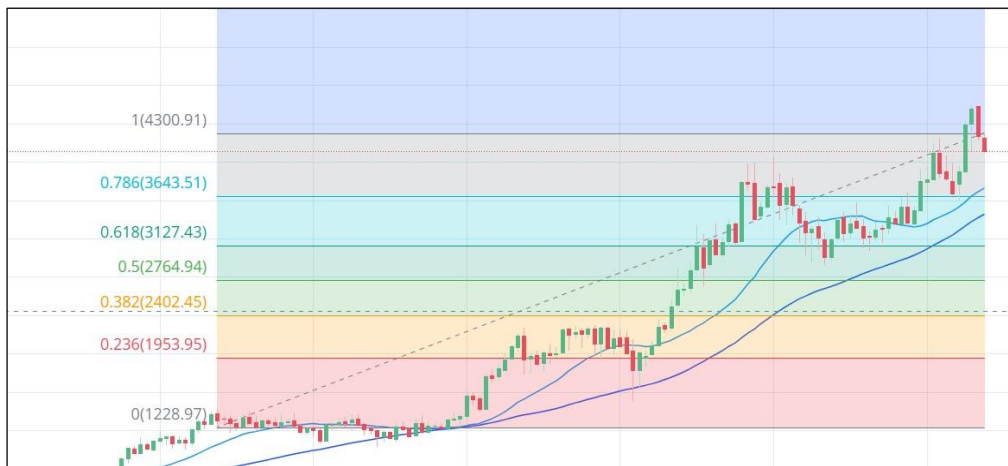

Figure 2: Fibonacci retracement levels of TCS

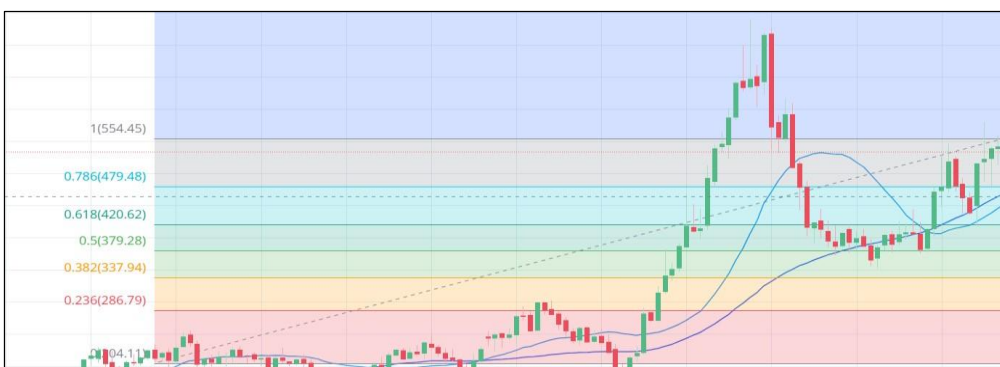

Figure 3: Fibonacci retracement levels of Wipro



Figure 4: Fibonacci retracement levels of Dr. Reddy's

Applicability of Fibonacci Series on Low Beta Stocks of Nifty-50

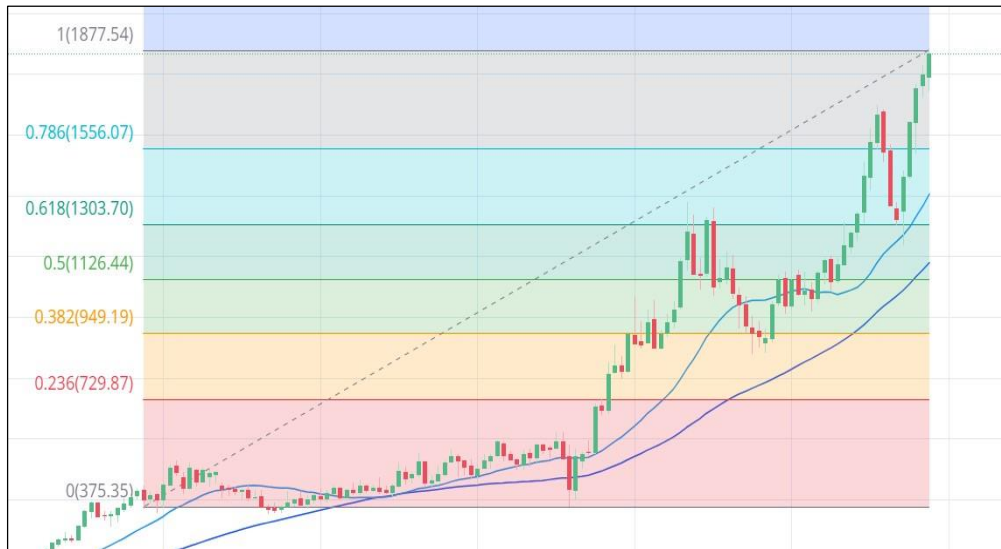

Figure 5: Fibonacci retracement levels of HCL Tech

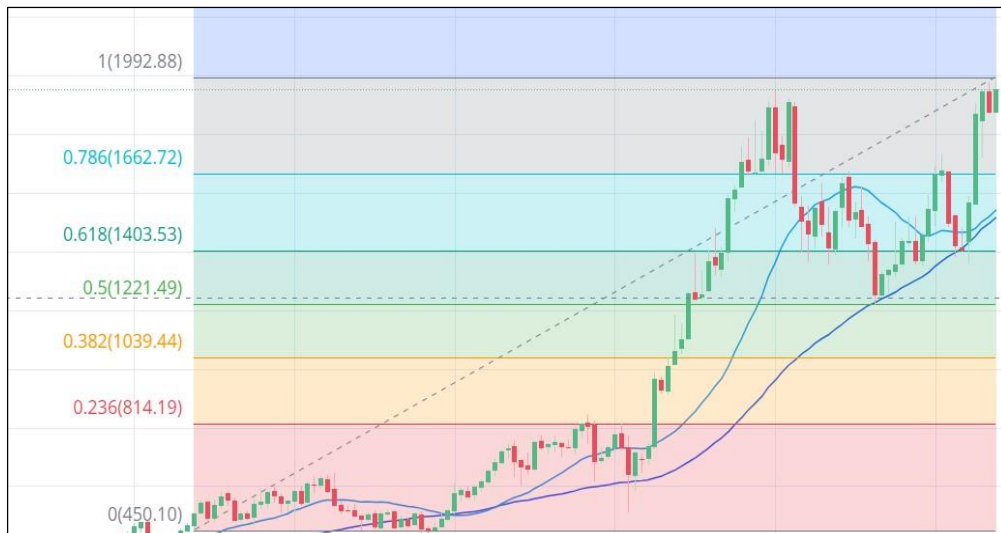

Figure 6: Fibonacci retracement levels of Infosys

RESULT & DISCUSSION

Fibonacci retracements in technical analysis are usually supposed to act as a level of support or resistance for the ongoing trends. These levels of retracements act as gives an indication of trend reversals, potential turning points where the price might reverse after a correction, these retracement levels are used to plan entry and exit points. In figure 2, As we can see in this chart at 23.6% level or at price 1953.95, it is acting as support during those levels, after the couple of months fluctuating around this level it took support from here and shot up. But when it came to 38.2% level or at 2402.45 it didn't act as a resistance and broke right through it, without any pullbacks. When it reached at the level of 61.8% or at 3127.43 this level acted as a bit of resistance for the price for the couple of months as it was bouncing right back from it (acting as a resistance). After crossing the level of 61.8% the trend again went downwards in a couple of months and here the same level acted as a support for the stock to go back up breaking the resistance at 78.6% levels. In figure 3, As it is noticed again the 28.6% level which is at 286.79 the prices initially acted as a resistance, as the stock prices where bouncing right back from it. After a couple of months once the price crossed that level the price of the stock went on an upward trajectory. Here during the upward moves the levels of 38.2% wasn't that significant because it didn't act as either a resistance or a support. In the 61.8% level or at 420.62, it did act as a bit of a minor resistance but broke right through it for further upward trend, breaking the 78.6% level easily. After the couple of months, the stock price did fall and took support back from the 61.8% level which acted a support for the stock price. As seen in figure 4, In this case the 23.6% initially

Applicability of Fibonacci Series on Low Beta Stocks of Nifty-50

didn't act as resistance or a support, but after a couple of months this level acted as support in the latter stages. At 38.2% level or at 4447.86 this initially acted as resistance but broke right after that and signifying an up move. This level also acted a very strong support after it was crossed. The stock price went back and forth from this level as it was sometimes acting as a support and sometimes as a resistance before finally breaking from it. At 61.8% the price took a bit of support and moved onwards and upwards before breaking the weak resistance at 78.6%. In figure 5, At 38.2% level or at 949.19 the stock price acted as a resistance and then as a support, then it continued its upward move until 61.8%. at this level 1303.70 acted a very strong resistance for the price. Despite a couple of attempts to breakthrough this level it didn't break out and the stock fall and took support at 38.2% level again, before shooting up and finally crossing the levels of 61.8% and 78.6% in a single strong up move, before falling and taking support at 61.8%. As seen in figure 6, Here at 23.6% or at 814.19 as we can observe that this level has acted as a very strong resistance for the price. But once this level was broken it very easily went on to break the 31.8% level indicating that this wasn't a strong resistance, as it went on to cross the 61.8% and 78.6% level as well. After reaching its all-time high as it is seen the stock price fell from and took a really good support at 61.8% level again and then it shoots up.

CONCLUSION

The analysis of low beta stocks using the Fibonacci series reveals distinct risk-return profiles. High beta stocks, being more volatile, exhibit larger price fluctuations and are more sensitive to market movements (Majumdar, 2023a). High beta stocks, as mentioned above, are more volatile & hence they form multiple support & resistance levels when mapped to Fibonacci retracement levels. In contrast, low beta stocks demonstrate more stability and are less likely to breach Fibonacci levels frequently. This suggests that Fibonacci series can be a useful tool for identifying potential reversal points, especially in high beta stocks, offering insights for risk management. Even though the research includes data points spanning over a period of 10 years, it is important to acknowledge that those were monthly data points hence the graphs shown above may suffer from smoothening bias & hence show a better result as to how the stock prices coincide with the Fibonacci retracement levels. The future scope of research includes identifying if Fibonacci retracements work consistently across industries, across market capitalizations & across indexes.

REFERENCES

- 1) Dikici, R., & Özkan, E. (2003). An application of Fibonacci sequences in groups. *Applied Mathematics and Computation*, 136(2–3), 323–331. [https://doi.org/10.1016/S00963003\(02\)00044-9](https://doi.org/10.1016/S00963003(02)00044-9)
- 2) Kumar, R., Colony, B., & Rohtak, H. (2014). Magic of Fibonacci Sequence in Prediction of Stock Behavior. In *International Journal of Computer Applications* (Vol. 93, Issue 11).
- 3) Lahutta, D. (n.d.). *Technical Analysis of Price Formations with Fibonacci Sequence on Warsaw Stock Exchange*. www.worldscientificnews.com
- 4) Majumdar, A. (2023a). *The Impact of Fibonacci Retracement to Forecast the Support and Resistance of Select Indian Stocks and Indices*. <https://www.researchgate.net/publication/370133559>
- 5) Majumdar, A. (2023b). *The Impact of Fibonacci Retracement to Forecast the Support and Resistance of Select Indian Stocks and Indices*. <https://www.researchgate.net/publication/370133559>
- 6) Sinha, S. (2017). *The Fibonacci Numbers and Its Amazing Applications*. <https://www.researchgate.net/publication/330740074>
- 7) Zafarullah Shaker, R., & Zulfiqar, N. (2018). Do Predictive Power of Fibonacci Retracements Help the Investor to Predict Future? A Study of Pakistan Stock Exchange Muzaffar Asad. In *International Journal of Economics and Financial Research ISSN* (Vol. 4, Issue 6).



There is an Open Access article, distributed under the term of the Creative Commons Attribution – Non Commercial 4.0 International (CC BY-NC 4.0) (<https://creativecommons.org/licenses/by-nc/4.0/>), which permits remixing, adapting and building upon the work for non-commercial use, provided the original work is properly cited.

Management of Sports Facility Owned by Sleman Regency Government during the Pandemic Case Study of Maguwoharjo Stadium



Ridwan Khoiri¹, Wawan Sundawan Suherman²

^{1,2}Faculty of Sport and Health Science, Yogyakarta State University, Indonesia

ABSTRACT: This research aims to determine the management functions defined in the management of the Maguwoharjo Stadium and to determine the management process for the management of the Sleman Regency government. This research was compiled from theoretical studies related to management during the Covid 19 pandemic. This research was a descriptive qualitative study with observation, interview, and document study methods. The research subjects were UPT heads and Maguwoharjo Stadium staff as resource persons. This research was conducted at Maguwoharjo Stadium. The descriptive qualitative analysis was used to describe and explain the answers in more detail. Based on the research results, it can be seen that; (1) management functions that can be implemented during the Covid 19 pandemic by the Maguwoharjo Stadium manager are planning, organizing, and controlling functions. It is related to planning the management budget, organizing the process of managing and controlling the activities of Maguwoharjo stadium users in accordance with the health protocol, (2) the management of Maguwoharjo Stadium owned by the Sleman Regency government has been run properly related to the management of the Stadium from financing the maintenance budget and controlling activities at Maguwoharjo Stadium, (3) the strategy used by Maguwoharjo Stadium to carry on the services during the Covid-19 pandemic has provided an appeal for health protocols in activities within Maguwoharjo Stadium and continue to hold various sport events that attract the public's interest for doing sports as well as providing good and comfortable facilities and infrastructure, (4) the services provided by the Maguwoharjo Stadium are still based on the Sleman Regency government regulations.

KEYWORDS: Covid-19 pandemic, Management, Stadium

I. INTRODUCTION

In the early of 2020, Indonesia was shocked by the coronavirus covid 19 which greatly affected Indonesia's economic and social conditions. Indonesia's economic condition is highly affected by the covid 19 pandemic, including many people losing their jobs due to layoffs, consumers decreasing sharply, human movement is very limited and restricted because this virus is easily and quickly transmitted from human to human. The risk of transmission will increase significantly if there is direct contact with other people, not only do people lose their jobs but also many entrepreneurs and businessmen go bankrupt due to the covid 19 pandemic. Because many public places were closed due to the covid 19 outbreak, such as malls, sports facilities and infrastructure, shopping centers, tourist attractions, restaurants, coffee shops, even places of worship were also closed. This action was taken by the government to break the chain of transmission of the coronavirus covid 19. Susilo et al., (2020: 45) stated that on March 2, 2020 the first 2 cases of covid 19 were reported, there were many pros and cons against this virus. Since this coronavirus has entered Indonesia, the Indonesian government has immediately taken quick steps to break the chain of transmission of this virus. The efforts made by the government include requiring the use of masks, maintaining distance, not allowing direct contact and requiring the use of hand sanitizers and implementing a system of restricting community activities or what is usually called PPKM. The government must be more assertive in emphasizing the community to always comply with the established protocols, this clearly affects the impact of the transmission of the coronavirus covid 19 in Indonesia. The number of covid 19 cases in Indonesia is currently quite high. The most serious challenge for the Indonesian government is the aspect of behavioral change, because basically the coronavirus covid 19 is closely related to community behavior, of course this behavioral change cannot happen just like that, it takes time and education for the community to be able to adapt to behavior during this pandemic. There are many

Management of Sports Facility Owned by Sleman Regency Government during the Pandemic Case Study of Maguwoharjo Stadium

changes in behavior, starting from having to use masks at all times, maintaining distance between individuals, washing hands with soap, using hand sanitizers and changing the offline system to online such as implementing WFH or work from home and school systems that are accessed online through zoom meet, google meet and so on, in this era it seems as if we are all digital. Zulyan, (2021: 211) changes also have an impact on social aspects which include several aspects including attitudes, emotions, values, ethics, persuasiveness and genetics. The spread and increase in cases of coronavirus occurs very quickly and will have an impact on the decline of the economy in Indonesia, not only affecting the behavior of this covid 19 but of course also affecting the economic sector to decline. Yamali & Putri, (2020:386) stated that the main factor in human life is the economy, because it is closely related to daily life. Humans to meet their needs for food, drink, clothing, and others. Indonesia has experienced significant economic losses due to the covid 19 pandemic. In this case, it can also be ascertained that sports facilities and infrastructure in Sleman Regency have also experienced a significant decline. The decline in income from sports facilities and infrastructure in Sleman Regency is due to the many sports and non-sports events that have been postponed and cannot be obtained permission to be held because of this coronavirus or covid 19. This change in income is due to the high number of covid 19 cases. The physical distancing policy as an effort to break the chain of transmission of covid 19 which has an impact on the pattern of limiting human activities in various sectors of life, one of which is sports activities. This makes people who routinely carry out sports activities in public places experience difficulties due to the PPKM which is implemented by the government. If this is not handled wisely, it will risk making people experience a lack of movement. In addition, the limited access to leave the house tends to make people stay at home for a long time. During the pandemic, sports facilities were indeed not used often, unlike before the covid 19 pandemic, but the maintenance of sports facilities and infrastructure must still be carried out routinely and the biggest problem faced by some management of sports facilities and infrastructure is the lack of income from events or competitions that cannot be held, there are several factors that cause events or competitions cannot be implemented, of course the government is quite considering the possibility of additional covid 19 cases if events or competitions are held. There are several sports facilities and infrastructure that must receive routine maintenance such as stadiums, GORs, futsal fields, and others. This maintenance includes such as: cutting and watering grass, electricity maintenance, cables-cables including building maintenance. The average funds that must be spent to carry out all maintenance are estimated to be very large.

II. METHODS

This research is a descriptive study using a qualitative approach. Qualitative descriptive research aims to describe, paint, explain, and answer in more detail the research problem to be studied by studying as much as possible an individual, a group, or an event. In qualitative research, humans are the research instrument and the results of the writing are in the form of words or statements that are in accordance with the actual situation. In this study, the author collected data by conducting direct interviews with informants to obtain information about the management of sports facilities during the Covid-19 pandemic. The research object includes the management of facilities and infrastructure during the pandemic.

III. RESULT

This research was conducted at Maguwoharjo Stadium, located at Jl. Kepuhsari, Jenengan, Maguwoharjo, Depok District, Sleman Regency, and Special Region of Yogyakarta 55281. The research was carried out from September 15, 2022 to October 1, 2022.

Data is the most important part of research because with data researchers can know the results of the research. Data for this research was obtained from various available sources, using existing data collection techniques and will be carried out continuously until the researcher obtains the desired data, in accordance with the characteristics of the data required in this research. Therefore, the following techniques are used in this research to collect data:

a. Observation

Fennie quoted by Novianti, (2012: 23) observation is the process of observing, paying attention to, and monitoring a part as a whole. Observation in qualitative research is carried out in a natural situation as if there are no changes beforehand and everything is as it is. The observation used in this research is direct observation, direct observation in this research is used to reveal the management of sports facilities during the Covid-19 pandemic.

b. Interview

An interview is the process of collecting data by the process of obtaining information from respondents by way of questions and answers and using interview guidelines. This means that in conducting interviews, researchers have prepared research instruments in the form of written questions and in the interview the author will record what is said by the respondents. Here, the researcher conducted interviews with the head of the UPT and staff of the Maguwoharjo Stadium.

Management of Sports Facility Owned by Sleman Regency Government during the Pandemic Case Study of Maguwoharjo Stadium

c. Document Study

Documentation is a form of activity or a systematic process in carrying out searching, using, investigating, collecting, and providing documents to obtain enlightenment of knowledge, information, as well as evidence and also distributing it to stakeholders. Documentation has the function of providing information related to the content of the document for its users, evidence and accurate data related to the information of the document, the role of documentation here is to assist services in terms of documentation, help develop knowledge, create and develop ways of managing documents. In this document study, researchers can search for many types of documents, from written or unwritten documents including works, images, or from the electronic aspect. There are many sources of information that are stored in it and there are also many materials and types of documents that exist. Then the documents obtained can be analyzed and combined to form a complete study. The information in the material and type of document is very broad, so that the excavation of information sources of data using the documentation method will greatly affect the quality of the research results.

IV. DISCUSSION

This research was conducted at Maguwoharjo Stadium, located at Jl. Kepuhsari, Jenengan, Maguwoharjo, Depok District, Sleman Regency, Special Region of Yogyakarta 55281. The research was carried out from September 15, 2022 to October 1, 2022.

a. Management Functions Implemented in the Management of Maguwoharjo Stadium

The management functions that can be implemented in the management of Maguwoharjo Stadium during the Covid-19 pandemic include planning, organizing, and controlling. Planning carried out by the management of Maguwoharjo Stadium is related to the maintenance cost budget, which is naturally disrupted by the reduced income of the stadium. This changing budget will certainly change the planning of the management process of the Maguwoharjo Stadium which is adjusted to the conditions of the Covid-19 pandemic. This planning is done to provide a solution so that the management of the Maguwoharjo Stadium can continue to run under the shadow of minimal managed funds. Indartono, (2013: 2.) states that management is a process of planning, organizing, staffing, and controlling to achieve certain goals. Budget planning with adjustments to the activities and management activities of the Maguwoharjo Stadium as happened in the maintenance process. For example, the routine of cutting grass, which is done every two weeks, must have its budget cut so that the cutting is carried out every four weeks. This condition shows that proper management planning will greatly help reduce the maintenance burden itself. In the second step where the manager has certainly carried out internal and external organization in the management of the Maguwoharjo Stadium. In the process of planning management programs, of course, the manager does not simply plan it himself and does not coordinate with other parties who have the authority and support for the continuation of the Maguwoharjo Stadium. Organizing activities and using this budget is very important for the continued management of the Maguwoharjo Stadium. In addition, another important function is control. Controlling the number of activities, actors of activities, and behavior of activity users of the Maguwoharjo Stadium facilities is also proof that the manager is able to provide maximum control. The management of the Maguwoharjo Stadium can gradually relax the implementation of sports activities at the Maguwoharjo Stadium. However, the management still appeals to continue to implement health protocols to the maximum. This condition is certainly also done to be able to maintain permission from the government for the implementation of sports activities in a limited manner.

b. Management of the management of Maguwoharjo Stadium carried out by the Sleman Regency government

The Covid-19 pandemic greatly affects the activities of sports facilities, especially with the restrictions on activities, which reduces the income obtained by the management of Maguwoharjo Stadium. With the influence of the Covid-19 pandemic on income, the management of maintenance costs for facilities and infrastructure at Maguwoharjo Stadium requires special measures. Management management needs to be carried out to be able to provide a balance between the implementation of the utilization and management of Maguwoharjo Stadium to the maximum.

Purnama & Setyawan, (2019: 35) Management management is a process in which there is cooperation through people or organizational resources to adjust management strategies so that they can overcome changes in human interaction to achieve goals. Management management is carried out from the process of maintenance, utilization of services and control of services that have been provided to the community. The management of Maguwoharjo Stadium is greatly influenced by the cost conditions where in the implementation of grass maintenance, for example, which is done every two weeks, is carried out every four weeks. This condition shows that the costs that must be incurred by the management management must be able to minimize the maintenance budget that is out but still in the maintenance process according to standards. The management of Maguwoharjo Stadium can also be seen in the implementation of the usual agendas that depend on the appeal according to the conditions of the Covid-19 pandemic. The management implementation of management carried out by the manager is the maintenance of the

Management of Sports Facility Owned by Sleman Regency Government during the Pandemic Case Study of Maguwoharjo Stadium

field grass, maintaining facilities such as toilets and other facilities. While its main function as a supporter of the implementation of the football league also depends on the implementation from the center. So that the use of the field is also still limited to the applicable regulations from both PSSI and the Ministry of Health. This condition shows that its management management is very important to be carried out in order to carry out these programs to the maximum. Gradually, the management of the Maguwoharjo Stadium facilities is very important to be referred to in the new era era. The manager slowly to make changes to activities that can be carried out in the era of the Covid-19 pandemic change. Where adaptation in the new normal or new habits is very important for the continued management of Maguwoharjo Stadium in particular.

c. Maguwoharjo Stadium Management Strategies to Maintain Existence and Services during the COVID-19 Pandemic

Herry Krisnandi and Suryono Efendi (2019: 3) state that management comes from the English word "to manage," which means to take care of, regulate, and manage. Maintaining existence and services during the COVID-19 pandemic is very important so that Maguwoharjo Stadium can continue to operate even though major changes have occurred. As a manager of public facilities that provides services to the general public and activities that have the potential to create crowds, it is a special concern that as individuals, we must be able to adapt to the current conditions and situations. Vigilance is the key to managing Maguwoharjo Stadium. In the process of carrying out maintenance, managing, and promoting public facilities at Maguwoharjo Stadium, of course, the management does not simply follow its own desires. Instead, regulations and SOPs that have been adapted to the conditions of the COVID-19 pandemic have been made by the government. The regulations that apply to the use of Maguwoharjo Stadium facilities have been adjusted to the conditions of government regulations. These regulations have certainly been adapted to health protocols that prioritize the safety and security of public facility users during the COVID-19 pandemic. Anxiety and concern about the transmission and spread of COVID-19 continue to gradually improve with the presence of confidence in the field that makes someone psychologically strong in facing the COVID-19 pandemic. Specifically, in the process of facing the COVID-19 pandemic for the implementation of services at Maguwoharjo Stadium. This situation will certainly help in the process of maintaining the existence of services from the Maguwoharjo Stadium to the maximum.

d. Services Provided by Maguwoharjo Stadium during the COVID-19 Pandemic

Controlling is an activity that has been regulated and ensures that the activity runs according to what has been planned to achieve the goal. The first adaptation was carried out with a strong psychological attitude towards a new lifestyle, which is felt that someone must prepare a mask to help interact with others. Likewise, with sports activities in the Maguwoharjo Stadium environment, which require users to continue wearing masks while in the stadium environment. In line with the statement above, it shows that the manager provides stadium utilization services according to the proposals received. This situation certainly goes through a consideration of safety and security together. This consideration is very important considering that there are still restrictions in place and it is possible to reject proposals if they do not meet the applicable procedures. The services provided are certainly still in accordance with the applicable procedures so that activities and services can be in the form of routine services from the management or from external requests. In line with the statement above, it shows that the management of Maguwoharjo Stadium has provided services back to normal before but with an appeal to maintain health protocols. This condition shows that the services at Maguwoharjo Stadium are gradually improving while still paying attention to health protocols.

V. CONCLUSIONS

Based on the research above, it can be concluded that:

1. The management functions that can be implemented during the COVID-19 pandemic by the management of Maguwoharjo Stadium are planning, organizing, and controlling functions. This is related to the planning of management budget, organizing the process of managing and controlling the activities of Maguwoharjo stadium users in accordance with health protocols.
2. The management of Maguwoharjo Stadium carried out by the Sleman Regency government has been carried out properly related to the management of the Stadium from the financing of maintenance budgets and controlling activities at Maguwoharjo Stadium.
3. The strategy used by Maguwoharjo Stadium to remain active and provide services during the COVID-19 pandemic is to provide health protocol appeals for activities in the Maguwoharjo Stadium environment and to continue to hold various sports events that attract public interest in sports as well as provide good and comfortable facilities and infrastructure.
4. The services provided by Maguwoharjo Stadium during the COVID-19 pandemic are appeals and psychological strengthening for users of facilities, especially sports activities in health protocols. The services provided are certainly still in accordance with the applicable procedures so that activities and services can be in the form of routine services from the management or from external requests.

Management of Sports Facility Owned by Sleman Regency Government during the Pandemic Case Study of Maguwoharjo Stadium

VI. RECOMMENDATIONS

Based on the description of the results of the research that has been carried out, the researchers provide the following suggestions:

1. For future researchers, this thesis is expected to be used as comparative information with a similar topic but with different location settings and experiences.
2. For the management of public facilities affected by the COVID-19 pandemic, it is expected to provide simulations of safe activities to continue activities in accordance with health protocols.

REFERENCES

- 1) Erlina dkk. (2020). Pneumonia Covid-19 Diagnosis danpenatalaksanaan di Indonesia. Jakarta: Perhimpunan Dokter Paru Indonesia.
- 2) George R. Terry. (2013). Dasar dasar manajemen.
[https://repository.widyatama.ac.id/xmlui/bitstream/handle/123456789/6350/Bab 2.pdf?sequence=11](https://repository.widyatama.ac.id/xmlui/bitstream/handle/123456789/6350/Bab%20.pdf?sequence=11)
- 3) Gunawan, A., Mahendra, I. R., & Hidayat, A. (2021). Pengelolaan Sarana dan Prasarana Olahraga Management of Sports Facilities and Infrastructure. *Salus Cultura: Jurnal Pembangunan Manusia Dan Kebudayaan*, 1–11.
- 4) Harsuki (2012: 119-120). (2012). Manajemen Olahraga. In *Journal of Chemical Information and Modeling* (Vol. 53, Issue 9).
- 5) Henricus Suparlan, Marce, T. D., Purbonuswanto, W., Sumarmo, U., Syaikhudin, A., Andiyanto, T., Imam Gunawan, Yusuf, A., Nik Din, N. M. M., Abd Wahid, N., Abd Rahman, N., Osman, K., Nik Din, N. M. M., Pendidikan, I., Koerniantono2, M. E. K., Jannah, F., Stmik, S., Tangerang, R., No, J. S., ... Suspendi, P. (2015). Imam Gunawan. *PEDAGOGIA: Jurnal Pendidikan*, 2(1), 59–70.
[http://journal.uin-alauddin.ac.id/index.php/sls/article/viewFile/1380/1342%0Ahttp://mpsi.umm.ac.id/files/file/55-58 Berliana Henu Cahyani.pdf](http://journal.uin-alauddin.ac.id/index.php/sls/article/viewFile/1380/1342%0Ahttp://mpsi.umm.ac.id/files/file/55-58%0ABerliana%20Henu%20Cahyani.pdf)
- 6) Herry Krisnandi, Suryono Efendi, dan E. S. (2019). PENGANTAR MANAJEMEN Panduan menguasai Ilmu Manajemen.
- 7) Indartono, S. (2013). Pengantar Manajemen : Character Inside.
- 8) Natal, Y. R., & Bate, N. (2020). Yanuarius Ricardus Natal Yanuarius Ricardus Natal dan Nikodemus Bate PENDAHULUAN Pembangunan manusia dalam bidang pendidikan merupakan salah satu upaya peningkatan kualitas hidup masyarakat Indonesia yang ditempuh melalui upaya peningkatan kesehatan jasmani. 9(2), 70–82.
- 9) Novianti, R. (2012). Teknik Observasi Bagi Pendidikan Anak Usia Dini. *Educhild*, 01(1), 22–29.
- 10) Purnama, L., & Setyawan, F. H. (2019). Manajemen Pengelolaan Fasilitas Olahraga Milik Pemerintah Kabupaten Ngawi Tahun 2018. *Jurnal Pendidikan Modern*, 5(1), 32–41. <https://doi.org/10.37471/jpm.v5i1.65>
- 11) Rahmi, F. C. (2019). Manajemen Pengelolaan Fasilitas Olahraga Gedung Serbaguna Di Gelanggang Olahraga (Gor) Delta Sidoarjo. *Jurnal Kesehatan Olahraga*, 7, 1–6.
- 12) Susilo, A., Rumende, C. M., Pitoyo, C. W., Santoso, W. D., Yulianti, M., Herikurniawan, H., Sinto, R., Singh, G., Nainggolan, L., Nelwan, E. J., Chen, L. K



There is an Open Access article, distributed under the term of the Creative Commons Attribution – Non Commercial 4.0 International (CC BY-NC 4.0) (<https://creativecommons.org/licenses/by-nc/4.0/>), which permits remixing, adapting and building upon the work for non-commercial use, provided the original work is properly cited.

The Use of Tiktok as a Tool for English Grammar Instruction: An Analysis of the @Excellentinhousetraining Tiktok Account



Elly Tri Suryati¹, Venny Eka Meidasari², Mashadi Said³

^{1,2}Postgraduate School, Indraprasta PGRI University, Jakarta

³Faculty of Communication Sciences, Universitas Pancasila, Jakarta

ABSTRACT: This study investigates the potential of TikTok as an educational tool for English grammar instruction focusing on the @excellentinhousetraining TikTok account. With the rising use of social media in education, this study explores how TikTok's unique multimedia and interactive features can make grammar lessons more engaging and accessible for Generation Z learners. Using a qualitative approach, the study analyzes grammar-focused videos from @excellentinhousetraining published between 2023 and 2024. Key findings reveal that TikTok's audiovisual format, concise content structure, and interactive elements include enhance learner engagement, facilitate content accessibility, and improve understanding of grammar concepts of their users. The study highlights TikTok's capacity to support flexible, self-paced learning and suggests that integrating social media-based modules into formal education could address engagement challenges in traditional grammar instruction. These insights position TikTok as a promising supplementary tool in modern language learning.

KEYWORDS: TikTok, grammar instruction, social media in education, Generation Z, English language learning

INTRODUCTION

The advent of social media has significantly transformed the landscape of education, with platforms like TikTok providing novel avenues for engaging students, especially young learners, in interactive and accessible ways. TikTok, known for its short-form videos and engaging content, has gained immense popularity among the younger generation, offering not just entertainment but also opportunities for learning (Bahri et al., 2022). Within this digital shift, English grammar—a subject traditionally regarded as difficult and unappealing—can potentially benefit from fresh, technology-aligned instructional approaches (Limpo et al., 2023). This study, therefore, focuses on the @excellentinhousetraining TikTok account as a case study, exploring how the platform's features can be utilized to present grammar lessons effectively.

In traditional settings, grammar instruction often relies on rote memorization and rigid structure, which many students find monotonous and challenging. This approach has led to a pervasive lack of enthusiasm and engagement in grammar lessons, further hampering language proficiency development (Rizal, 2023). Recognizing these challenges, the study considers TikTok as a potential solution, capitalizing on its dynamic and familiar platform to make grammar learning more accessible and appealing. The shift from textbooks to TikTok provides a refreshing change that aligns well with the multimedia habits of young learners today (Pimmer & Mateescu, 2020).

TikTok's appeal lies in its brevity, accessibility, and highly visual content, making it a suitable medium for delivering grammar lessons that are both educational and entertaining. The platform's format allows for concise presentations of complex grammar topics, making them easier to understand and retain (Kaplan & Haenlein, 2010). Given TikTok's massive popularity among young people, this study positions the platform as a valuable educational tool that can help overcome the traditional difficulties associated with grammar instruction, ultimately making the learning process more engaging and effective (Manca & Ranieri, 2016).

The @excellentinhousetraining TikTok account exemplifies how educational content can be presented in a manner that appeals to the digital preferences of Generation Z. By leveraging TikTok's audiovisual features and interactive tools, this account creates an engaging and enjoyable learning experience that is often lacking in conventional grammar lessons (Northey et al., 2018).

This study aims to analyze the capacity of TikTok account @excellentinhousetraining to support flexible and self-paced learning that integrates social media-based modules addressing engagement challenges in traditional grammar instruction.

The Use of Tiktok as a Tool for English Grammar Instruction: An Analysis of the @Excellentinhousetraining Tiktok Account

Through this analysis, the study hopes to understand the extent to which TikTok-based instruction can transform the traditionally tedious task of grammar learning into an enjoyable educational pursuit (Greenhow & Lewin, 2016).

REVIEW OF RELATED LITERATURE

Social Media in Education

Social media has gained significant recognition as a powerful educational tool, revolutionizing the way educators engage with students and facilitate learning. Kaplan and Haenlein (2010) discuss the potential of social media to provide interactive, flexible, and engaging environments that can supplement traditional educational methods. Integrating social media platforms into teaching strategies allows educators to create dynamic, multimedia-rich learning experiences that resonate with students' digital habits (Manca & Ranieri, 2016). This shift underscores the potential of social media to make learning more accessible, appealing, and adaptable, particularly for subjects requiring interactive engagement and varied formats.

Platforms such as Facebook, Twitter, and TikTok lead this transformation by supporting a wide range of user-generated content that educators can leverage in innovative ways to enrich the learning process (Greenhow & Lewin, 2016). These platforms enable collaboration, information sharing, and community building, helping to extend educational experiences beyond conventional classroom boundaries. Cahyono (2016) points out that these social media platforms encourage active participation and create spaces where students can share resources, engage in discussions, and even produce their own content, fostering a sense of community and ownership over their learning.

TikTok, with its short, visually appealing videos and creative tools, exemplifies the educational potential of social media (Northey et al., 2018). Educators are increasingly utilizing TikTok to simplify complex topics, breaking them down into digestible segments that capture students' attention and facilitate understanding. As Pimmer and Mateescu (2020) observe, the platform's popularity and user-friendly interface allow for the creation and sharing of content that is both educational and entertaining, effectively bridging the gap between formal education and informal online learning. TikTok's format, therefore, offers a compelling way to engage young learners, making it a valuable addition to modern educational practices.

Grammar Teaching Challenges

Traditional grammar instruction has often been criticized for its perceived rigidity and complexity, which tend to discourage student engagement and motivation. The conventional methods, which frequently rely on rote memorization and repetitive exercises, can make grammar seem abstract and uninteresting, especially to younger learners who may struggle to see its practical relevance in everyday communication (Calanoga, 2019). This approach has created a barrier in language education, where grammar is viewed as a tedious and challenging subject rather than a useful tool for effective expression. As a result, many students develop an aversion to grammar lessons, which ultimately impacts their overall language proficiency.

Despite these challenges, effective grammar instruction remains a fundamental component of language skills development. Grammar serves as the structural backbone of any language, allowing speakers and writers to convey ideas with clarity and precision. Without a solid understanding of grammar, students may struggle with miscommunication or unclear expression, which can limit their confidence and effectiveness in real-world interactions (Rizal, 2023). Moreover, well-taught grammar is crucial for students who wish to excel in both academic and professional settings, where polished communication skills are increasingly valued. A clear grasp of grammatical rules empowers learners to express themselves accurately, contributing to stronger, more meaningful exchanges in both written and spoken forms.

Recognizing the importance of grammar and the limitations of traditional instruction, educators and researchers are exploring new approaches to make grammar lessons more engaging and accessible. By integrating technology and interactive tools, such as multimedia platforms or social media, educators can shift away from traditional methods toward ones that are visually and contextually rich, which may help students appreciate the practical applications of grammar. Innovative methods, like those offered by social media platforms such as TikTok, hold the potential to make grammar instruction more appealing and effective, addressing longstanding issues of student engagement while maintaining the instructional rigor necessary for comprehensive language development (Manca & Ranieri, 2016; Greenhow & Lewin, 2016).

TikTok as a Learning Platform

TikTok's distinctive blend of video, music, and interactive features has positioned it as a compelling platform for educational purposes, providing a fresh approach to teaching that engages students on a personal level (Nasem et al., 2019). Unlike traditional learning tools, TikTok's format is inherently social and visually dynamic, which appeals particularly to younger learners who are accustomed to consuming content in quick, entertaining bursts. The platform's design allows users to combine audio and

The Use of Tiktok as a Tool for English Grammar Instruction: An Analysis of the @Excellentinhousetraining Tiktok Account

visual elements creatively, enabling educators to present material in an engaging and relatable manner that can enhance students' understanding and retention of complex topics.

The platform's short, visually appealing videos are especially suitable for teaching complex subjects like grammar, which can otherwise be challenging to convey in traditional formats. By breaking down grammar rules into concise, engaging segments, TikTok facilitates quick and digestible presentations that are easy for students to absorb (Bahri et al., 2022). This format helps students process information incrementally and interactively, making abstract or intricate topics feel more manageable. Moreover, TikTok's algorithm promotes relevant content based on users' interests, increasing the likelihood that students will encounter educational videos that align with their learning needs, reinforcing their understanding outside of the classroom.

Research shows that students respond positively to TikTok as a learning tool due to its familiarity and entertaining approach to educational content. Studies have found that students are more likely to engage with learning material presented on TikTok because the platform mirrors the digital environments they frequent, thereby reducing the perceived formality of the learning experience and fostering a sense of enjoyment and curiosity (Limpo et al., 2023). This positive response not only enhances motivation but also suggests that TikTok has the potential to bridge the gap between formal education and the digital lives of students, offering an innovative, student-centered approach to learning that is both effective and enjoyable.

METHOD

This study employs a qualitative descriptive approach to examine the educational content of the @excellentinhousetraining TikTok account, specifically focusing on videos related to grammar instruction. Data collection involved systematically observing grammar-focused videos posted between 2023 and 2024, with a range of viewership from 8,000 to 600,000. These videos were analyzed to identify thematic focuses, engagement strategies, and the effectiveness of grammar concept delivery. By exploring the structural aspects of each video, this study aims to understand how TikTok's format influences learning outcomes, with attention given to the style, duration, and audiovisual elements that make these grammar lessons engaging and accessible (Creswell, 2013).

The analytical process included categorizing videos based on grammar topics, examining presentation techniques, and assessing viewer responses using metrics such as comments, likes, and shares, which offer insight into audience engagement and reception (Denzin & Lincoln, 2018). This multi-faceted approach allows for a comprehensive evaluation of how well the videos communicate grammar concepts and resonate with viewers. Additionally, qualitative comment analysis provided valuable feedback regarding users' perceptions and the instructional clarity of the content, offering a nuanced view of how TikTok might be leveraged as an effective medium for language learning. This methodological approach aligns with recent qualitative research practices that emphasize rich, detailed descriptions and the subjective experiences of participants (Tracy, 2024).

RESEARCH RESULTS

The analysis reveals three key findings on the effectiveness of TikTok's format in teaching English grammar. These findings include enhanced learner engagement, improved content accessibility, and increased understanding of grammar concepts among users, as evidenced by interactions with the @excellentinhousetraining account.

First, enhanced engagement is a primary benefit of TikTok's format for teaching English grammar. TikTok videos, which incorporate background music, filters, and interactive elements, capture learners' attention more effectively than traditional textbook approaches. These multimedia components create a more immersive and enjoyable experience, fostering a positive learning environment that encourages students to engage actively with the content. In this way, TikTok's interactive style provides a refreshing alternative to conventional methods, making the learning process feel more dynamic and accessible.

Additionally, TikTok's interactive approach makes grammar lessons especially appealing to learners who are accustomed to visually rich social media platforms. By presenting grammar content through familiar digital formats, TikTok helps bridge the gap between traditional education and modern learning preferences. This alignment with current media consumption habits enhances the overall appeal and accessibility of grammar lessons, allowing students to connect with the material in a way that feels relevant and engaging to their daily lives.

Second, content accessibility emerges as a distinct advantage of TikTok's short-form structure. The platform's brief, focused grammar lessons allow users to learn at their own pace, an ideal setup for busy students or those who find extended lessons challenging. TikTok's concise format makes specific grammar points digestible without overwhelming learners, providing the flexibility to revisit lessons as needed. This on-demand, bite-sized learning model encourages self-paced study and accommodates individual learning needs that are often unmet in traditional classroom settings.

The Use of TikTok as a Tool for English Grammar Instruction: An Analysis of the @Excellentinhousetraining TikTok Account

Furthermore, TikTok's accessibility extends to the autonomy it grants students, empowering them to engage with grammar concepts on their own schedules. This flexibility supports various learning preferences, allowing users to revisit and reinforce their understanding as often as they like. The platform's mobile-friendly design also enhances accessibility, enabling students to seamlessly integrate learning into their everyday routines without the constraints of formal classroom structures.

Third, TikTok's audiovisual format significantly improves users' understanding of complex grammar concepts. Accounts like @excellentinhousetraining use visuals and concise explanations to demystify challenging grammar rules, making them easier to comprehend and retain. This multimedia approach, combining verbal explanations with visual aids, reduces cognitive load and enhances both comprehension and retention, making abstract concepts more concrete and approachable for learners.

By integrating visuals, sound, and clear, focused explanations, TikTok offers a deeper and more holistic understanding of grammar rules. This multimedia-rich format makes abstract concepts more accessible and provides a practical approach to language education that aligns with how digital-native learners process information. As a result, TikTok's format proves highly effective in transforming grammar instruction into a more engaging, accessible, and comprehensible experience.

DISCUSSION

The analysis revealed that TikTok's format is highly effective in delivering English grammar lessons, as demonstrated by the significant engagement on the @excellentinhousetraining account. Key findings include:

1. Enhanced Engagement

The result indicating enhanced engagement through TikTok videos with background music, filters, and interactive elements aligns closely with the aim of the study regarding the effectiveness of social media in teaching English grammar. TikTok's format seems to cater well to Generation Z's digital preferences, utilizing short, visually rich, and sound-enhanced content that captures and sustains attention more effectively than traditional textbook approaches. This engagement aspect is critical, as literature suggests that student motivation is a significant predictor of learning outcomes, especially in language acquisition (Limpot et al., 2023). By tapping into elements familiar to students in their daily digital interactions, TikTok reduces the perceived gap between formal learning and leisure, making grammar instruction feel less intimidating and more approachable (Bahri et al., 2022).

This finding is supported by existing literature on multimedia learning, which suggests that visual and auditory elements can significantly enhance cognitive engagement and information retention (Mayer, 2014). TikTok videos utilize background music and filters to create a relaxed, inviting atmosphere that lowers the cognitive load typically associated with studying grammar. When students are more relaxed and engaged, they are better positioned to absorb and retain new material (Mayer, 2014). This is especially important in grammar instruction, where engagement can be challenging due to the perceived difficulty and abstract nature of grammatical concepts (Calanoga, 2019). TikTok's use of multimedia aligns with Mayer's (2014) Cognitive Theory of Multimedia Learning, which posits that learning is more effective when verbal and visual information are integrated, reducing the mental effort required to understand complex information.

The interactive features of TikTok, such as likes, comments, and shares, also foster a sense of community and active participation, reinforcing students' engagement and motivation (Greenhow & Lewin, 2016). Social interaction on digital platforms has been shown to encourage collaborative learning, where students can share insights, ask questions, and receive feedback in real-time (Denzin & Lincoln, 2018). This aligns with social constructivist theories, which highlight the importance of social engagement in learning and knowledge construction (Vygotsky, 1978). By enabling students to interact with each other and the content creator, TikTok provides an environment where learning is not only individualized but also socially supported, further enhancing student motivation and engagement with grammar lessons. This result, therefore, suggests that platforms like TikTok, which combine multimedia and interactive elements, could be a valuable supplement to traditional language learning methods.

2. Content Accessibility

The finding that grammar lessons on TikTok are brief and focused, allowing users to learn at their own pace, aligns directly with the research question concerning the adaptability of social media platforms for grammar instruction. TikTok's short-form videos meet the needs of contemporary students, many of whom face time constraints or find extended lessons overwhelming. This result suggests that TikTok can serve as a viable educational supplement, offering compact grammar lessons that students can absorb without dedicating lengthy periods, which is especially advantageous for self-directed and busy learners (Limpot et al., 2023). The ability to control pacing is a critical aspect, as educational psychology literature emphasizes that learners benefit from being able to revisit and review challenging material on their terms (Mayer, 2014).

This brevity and focus align with Mayer's (2014) Cognitive Theory of Multimedia Learning, which proposes that effective learning occurs when information is presented in small, manageable segments. TikTok's format inherently supports this concept by breaking down complex grammar rules into concise, easily digestible parts, which reduces cognitive load and enhances

The Use of Tiktok as a Tool for English Grammar Instruction: An Analysis of the @Excellentinhousetraining Tiktok Account

retention. When students are not overwhelmed by excessive information at once, they are better able to process, retain, and apply grammar rules (Sweller, 2017). This self-paced approach is particularly beneficial for language learners, as it allows them to review difficult concepts multiple times, reinforcing understanding without the pressure often associated with formal learning environments (Manca & Ranieri, 2016).

Furthermore, TikTok's on-demand, user-centered model offers flexibility, a factor highly valued in today's digital learning landscape. Students are free to choose when and how often they engage with grammar content, allowing them to learn during breaks, commute times, or other small pockets of free time throughout the day. Research suggests that microlearning—small, focused learning bursts—is especially effective for enhancing learning and retention in modern, fast-paced contexts (Hug, 2005). By supporting both convenience and learner autonomy, TikTok serves as a practical tool for those who might otherwise struggle to engage with grammar due to time limitations or attention span concerns. In the broader context of educational literature, this finding reinforces the idea that social media platforms can play a complementary role in formal education, addressing gaps in traditional instructional methods and meeting students where they are (Greenhow & Lewin, 2016).

3. Improved Understanding

The result demonstrating that TikTok's audiovisual format aids in explaining complex grammar concepts supports the research question concerning the role of social media in facilitating grammar instruction. TikTok's combination of visuals and concise explanations provides a powerful medium for making abstract or challenging grammar rules more accessible. This format, as seen in the @excellentinhousetraining account, simplifies grammar instruction by using short, focused visuals that illustrate rules in a straightforward, relatable way, which helps learners to grasp complex concepts more readily (Bahri et al., 2022). This approach aligns with Mayer's (2014) Cognitive Theory of Multimedia Learning, which posits that pairing words with relevant images enhances comprehension by engaging both verbal and visual processing channels, thus reducing cognitive load and promoting better retention.

The literature on multimedia learning underscores that multimodal instruction, which involves presenting information through both visual and auditory channels, enhances cognitive engagement and comprehension (Mayer, 2014; Sweller, 2017). For grammar instruction, which often requires understanding abstract rules and structures, the audiovisual features on TikTok provide scaffolding that supports students' understanding. By breaking down complex grammar concepts into short, easily digestible segments with visual aids, TikTok's format reduces the mental effort required for processing information, making it especially effective for learners who may struggle with grammar when presented through traditional text-based methods (Mayer, 2014). This supports findings from language education research, which show that visual aids help demystify language rules, making them easier to internalize and apply (Calanoga, 2019).

Moreover, the interactive nature of TikTok allows for instant feedback and repetition, which are valuable for reinforcing grammar rules. The @excellentinhousetraining account effectively uses this format to provide students with recurring exposure to grammatical structures, enabling incremental learning. The repetition and clarity provided by short, focused explanations promote long-term retention, as students can repeatedly engage with the content until they feel confident in their understanding. This ties into Vygotsky's (1978) social constructivist theory, which highlights the importance of supportive scaffolding in the learning process; here, TikTok's visuals and concise explanations act as scaffolds that guide learners through complex content incrementally. Additionally, research suggests that audiovisual tools in digital media can build learners' confidence by making material seem less intimidating, thus encouraging continued engagement with challenging subjects like grammar (Greenhow & Lewin, 2016).

These findings indicate that TikTok's audiovisual features provide an educational advantage by facilitating comprehension and retention in grammar learning. In this context, TikTok serves as a valuable supplementary resource that enhances traditional instruction, helping students to better understand and apply complex grammar concepts in a familiar, accessible format. This reinforces literature suggesting that digital platforms can complement formal education by offering alternative methods of content delivery that align with modern learning preferences and cognitive strategies (Manca & Ranieri, 2016; Greenhow & Lewin, 2016).

While high engagement metrics such as views, likes, and comments indicate a positive response to the grammar content on TikTok, they do not necessarily reflect true learning or mastery of grammar concepts. Engagement metrics primarily measure interest and interaction with the content, which, although valuable, do not confirm whether users have internalized or retained the material. Future study could address this limitation by incorporating pre- and post-assessments to directly measure learning outcomes related to grammar proficiency. By using assessments before and after exposure to TikTok-based grammar lessons, researchers could obtain a clearer picture of the platform's actual educational impact, providing more robust evidence of its effectiveness beyond engagement indicators alone.

It is also important to acknowledge that TikTok's effectiveness as a grammar instruction tool may vary across different demographic groups. Factors such as age, language proficiency, digital literacy, and learning preferences can significantly impact

The Use of Tiktok as a Tool for English Grammar Instruction: An Analysis of the @Excellentinhousetraining Tiktok Account

how users engage with and benefit from grammar content on social media platforms like TikTok. For example, younger users who are more accustomed to fast-paced digital content may find TikTok's format more engaging, while older or more advanced learners may require deeper, more comprehensive explanations not easily accommodated by TikTok's short-form format. Future studies could explore how these demographic variables influence engagement levels, comprehension, and overall learning outcomes. Such research could offer a more nuanced understanding of TikTok's educational value and provide insights into how content can be tailored to meet the diverse needs of learners on social media platforms.

IMPLICATION

The findings imply that social media platforms like TikTok hold significant promise for enhancing grammar instruction and can serve as highly effective supplementary tools in language education. By leveraging multimedia elements, concise content delivery, and interactive features, TikTok aligns with modern educational approaches that emphasize engagement, accessibility, and personalized learning (Greenhow & Lewin, 2016). Unlike traditional instruction methods that may struggle to capture the interest of younger learners, TikTok's format meets students where they are, blending educational content with the familiarity and appeal of social media (Limpo et al., 2023). This adaptability allows TikTok to complement formal education, offering a flexible, learner-centered environment that supports language acquisition in a dynamic, informal setting.

Moreover, these findings support research suggesting that digital media, when thoughtfully integrated into the curriculum, can facilitate incremental, self-paced learning, which is particularly beneficial in mastering complex subjects like grammar (Mayer, 2014; Manca & Ranieri, 2016). Platforms like TikTok enable students to engage with grammar concepts on their terms, revisiting content as needed and receiving immediate reinforcement through interactive elements. This aligns with Vygotsky's (1978) social constructivist theory, where the use of social media for language learning fosters collaborative and supported learning environments, encouraging students to take an active role in their education. As such, TikTok and similar platforms are valuable not only for reinforcing classroom learning but also for addressing challenges associated with traditional grammar instruction, such as lack of engagement and perceived difficulty (Sweller, 2017).

Ultimately, these implications suggest that integrating platforms like TikTok into educational strategies could offer a complementary pathway for language educators seeking to engage and motivate students. By combining accessibility, interactive feedback, and the cognitive benefits of multimedia, TikTok presents an innovative approach that aligns with contemporary digital learning preferences, providing a promising resource for enhancing grammar instruction and supporting students' language development (Bahri et al., 2022).

LIMITATION

The results of this study while valuable in demonstrating the potential of TikTok as a supplementary tool for grammar instruction have certain limitations that should be acknowledged:

- 1. Scope of Content Analysis**

This part effectively highlights the limitation of analyzing only a single TikTok account. The suggestion to expand future study to multiple accounts with diverse teaching styles is practical and aligns with the need for broader generalizability.

- 2. Lack of Direct Learning Assessment**

This section clearly points out the importance of measuring actual learning outcomes rather than relying solely on engagement metrics. Mentioning the use of pre- and post-tests in future study adds a specific and actionable recommendation for addressing this limitation.

- 3. Audience Demographics and Learning Preferences**

By acknowledging the diversity of TikTok users and their varied learning needs, this section adds depth to the analysis, indicating that the platform's effectiveness may vary across demographic groups. This is a thoughtful inclusion that strengthens the overall scope of limitations.

- 4. Engagement vs. Learning Quality**

The distinction between engagement and meaningful learning is well-placed. By suggesting that future study should differentiate between passive and active engagement, this section clarifies that high engagement alone does not guarantee educational effectiveness.

- 5. Platform-Specific Constraints**

This part effectively addresses the limitation imposed by TikTok's short-form format, noting that it may hinder detailed explanations necessary for complex grammar concepts. The comparison with platforms like YouTube provides useful context, highlighting TikTok's potential role as a supplementary tool rather than a comprehensive instructional medium.

The Use of TikTok as a Tool for English Grammar Instruction: An Analysis of the @Excellentinhousetraining TikTok Account

6. Dependence on Multimedia Appeal

The concern over TikTok's reliance on audiovisual stimulation is well-articulated, drawing attention to the risk that students may become overly reliant on such elements for engagement. This limitation is particularly insightful, as it raises questions about the platform's ability to prepare students for real-world grammar application.

7. Longitudinal Impact

The section discussing the lack of long-term assessment underscores the need for longitudinal studies to measure the retention of grammar concepts learned through TikTok. This is an important aspect that could determine TikTok's viability as a sustained educational tool.

8. TikTok's Short-Form Format for Comprehensive Grammar Instruction

This section is clear and contrasts well with other platforms that allow for more in-depth explanations. By emphasizing that TikTok's short-form format may be better suited as a supplementary tool, this part provides valuable context on TikTok's instructional limitations.

CONCLUSION AND SUGGESTIONS

This study underscores TikTok's potential as an innovative educational tool for teaching English grammar, demonstrating how the @excellentinhousetraining account effectively leverages the platform's multimedia features to engage Generation Z learners. By aligning grammar instruction with students' digital habits, TikTok fosters higher levels of engagement and accessibility, making grammar more approachable and appealing. The findings suggest that social media platforms like TikTok can serve as effective supplementary tools in language learning, providing learners with flexible, self-paced, and visually engaging alternatives to traditional grammar instruction. Educational institutions are encouraged to consider incorporating social media-based learning modules into their curricula, as such platforms align well with contemporary learning preferences and offer unique benefits for fostering student interest in challenging subjects.

In light of these findings, educators are encouraged to consider how TikTok's principles—brevity, multimedia engagement, and self-paced learning—might be adapted into traditional educational settings. Even without using TikTok directly, these principles can be applied by creating short, multimedia-rich lessons within the existing curriculum, offering students concise, visually engaging materials that enhance accessibility and motivation. By integrating these strategies, educators can leverage the engagement benefits observed on TikTok to make grammar instruction more appealing and effective in a variety of learning environments.

Given the limitations of this study, future study could expand on the following areas to deepen understanding of TikTok's role in grammar instruction:

1. Broader Content Analysis

Future studies should examine multiple TikTok accounts that provide grammar instruction to determine if findings from this study are consistent across diverse teaching styles and content. Comparing various accounts could offer a more comprehensive view of best practices and effective strategies for grammar teaching on TikTok.

2. Direct Learning Outcome Assessment

To evaluate the actual educational impact, future study could incorporate pre- and post-assessments, such as quizzes or tests, to measure whether students demonstrate improved grammar skills after engaging with TikTok content. Surveys and follow-up studies could also assess retention, helping determine if TikTok-based grammar lessons translate to measurable gains in language proficiency.

3. Audience Demographics and Preferences

Future studies could examine how demographic factors, such as age, prior language proficiency, and learning preferences, influence engagement and learning outcomes with TikTok grammar content. By analyzing diverse groups, researchers can gain insights into which demographics benefit most from this instructional approach and tailor content accordingly.

4. Distinguishing Engagement Types

Further study could differentiate between passive and active engagement with TikTok videos, examining whether high engagement metrics correlate with meaningful learning or are merely indicators of entertainment. Understanding how students interact with and apply grammar concepts could clarify the educational value of social media engagement metrics.

The Use of Tiktok as a Tool for English Grammar Instruction: An Analysis of the @Excellentinhousetraining Tiktok Account

5. Platform Constraints and Content Depth

Investigating the challenges posed by TikTok's short-form format for teaching more advanced grammar topics would provide valuable insights into its limitations. Future studies could assess whether certain grammar concepts are oversimplified on TikTok and explore ways to deliver complex material without compromising depth and quality.

6. Impact of Multimedia Dependency

Future study could explore the effects of high-stimulation learning on students' engagement and motivation in traditional learning settings. By examining if reliance on multimedia elements influences students' ability to engage with less visually stimulating materials, researchers can assess the implications of social media-based learning on overall educational preparedness.

7. Longitudinal Studies on Learning Retention

Long-term studies are needed to evaluate whether the positive effects of TikTok-based grammar instruction persist over time or diminish without additional reinforcement. Longitudinal study would clarify whether social media-based grammar learning has lasting benefits on language proficiency and could help determine if periodic review or supplementary methods are necessary for sustained learning.

REFERENCES

- 1) Bahri, A., et al. (2022). Aplikasi TikTok sebagai Media Pembelajaran Bahasa Inggris di Indonesia. *Jurnal Indonesia Sosial Sains*, 3(1), 1121-1130.
- 2) Calanoga, M. (2019). Challenges in Grammar Instruction: A Study on Student Motivation and Engagement. *Journal of Language Education*, 5(2), 112-120.
- 3) Creswell, J. W. (2013). *Qualitative Inquiry and Research Design: Choosing Among Five Approaches*. Thousand Oaks, CA: Sage.
- 4) Denzin, N. K., & Lincoln, Y. S. (2018). *The SAGE Handbook of Qualitative Research*. Sage Publications.
- 5) Greenhow, C., & Lewin, C. (2016). Social Media and Education: Reconceptualizing the Boundaries of Formal and Informal Learning. *Learning, Media and Technology*, 41(1), 6-30.
- 6) Hug, T. (2005). *Microlearning: Emerging Concepts, Practices and Technologies After e-Learning*. Proceedings of Microlearning 2005 Conference.
- 7) Kaplan, A. M., & Haenlein, M. (2010). Users of the World, Unite! The Challenges and Opportunities of Social Media. *Business Horizons*, 53(1), 59-68.
- 8) Limpo, A. P., et al. (2023). Aplikasi TikTok sebagai Media Pembelajaran Bahasa Inggris Selama Masa Pandemi Covid-19. *Journal of Educational Technology, Curriculum, Learning, and Communication*, 3(3), 88-93.
- 9) Manca, S., & Ranieri, M. (2016). Facebook and the Others. Potentials and Obstacles of Social Media for Teaching in Higher Education. *Computers & Education*, 95, 216-230.
- 10) Mayer, R. E. (2014). *Multimedia Learning* (2nd ed.). Cambridge University Press.
- 11) Nasem, A., et al. (2019). Educational Potential of TikTok: Transforming Social Media for Learning. *Journal of Digital Media Studies*, 7(4), 145-158.
- 12) Northey, G., Bucic, T., Chylinski, M., & Govind, R. (2018). Increasing Student Engagement Using Asynchronous Learning. *Journal of Marketing Education*, 40(2), 101-113.
- 13) Pimmer, C., & Mateescu, M. (2020). Transforming Learning Spaces: The Educational Potential of Social Media. *Education and Information Technologies*, 25(3), 1455-1469.
- 14) Rizal, M. (2023). *Kuasai English Grammar: Mahir Grammar Bahasa Inggris bagi Pemula*. Jakarta: Publisher Name.
- 15) Sweller, J. (2017). *Cognitive Load Theory*. Springer.
- 16) Tracy, S. J. (2024). *Qualitative research methods: Collecting evidence, crafting analysis, communicating impact*. John Wiley & Sons.
- 17) Wiley-Blackwell. Cahyono, B. Y. (2016). Harnessing Social Media for Educational Purposes. *Journal of Educational Technology*, 10(2), 142-153.
- 18) Vygotsky, L. S. (1978). *Mind in Society: The Development of Higher Psychological Processes*. Harvard University Press.

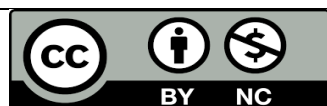

There is an Open Access article, distributed under the term of the Creative Commons Attribution – Non Commercial 4.0 International (CC BY-NC 4.0) (<https://creativecommons.org/licenses/by-nc/4.0/>), which permits remixing, adapting and building upon the work for non-commercial use, provided the original work is properly cited.

Beyond the Schools: How Parental Involvement Affects the Academic Performance of Nepali Public School Students?



Padam Poudel¹, Dhanapati Subedi², Niroj Dahal³

^{1,2,3}Kathmandu University School of Education, Lalitpur, Nepal

ABSTRACT: Parental involvement is crucial for achieving academic excellence and fostering personal development in contemporary educational institutions. Involving parents in their children's education promotes cognitive and interpersonal growth and improves academic achievements.

The involvement of parents in their children's education in Nepali public schools is the focus of this qualitative case study. Adopting social capital theories, this study explores engagement through interviews, documentation, and observations at a single school with four selected participants. Evidence indicates that active parental involvement has a substantial positive impact on student's academic achievement and acquisition of knowledge. The following are important ways parents can become more involved: a) enhancing children's education through SMC and PTA activities; b) fortifying the parent-teacher bond; c) boosting the home environment in comprehensive education; and d) enhancing school governance and management. The study emphasizes the necessity of implementing a comprehensive framework for parental involvement that supports decentralized management and encourages innovative adaptability. The network cooperation between schools, teachers, and parents is critical. Promoting parental involvement and cultivating connections among parents is essential for improving the educational atmosphere and ensuring academic excellence in public schools.

KEYWORDS: parental involvement, public school, school performance, student performance

INTRODUCTION

The potential beneficial impact of parental involvement on children's academic attainment has long piqued the curiosity of educational scholars (Epstein, 1991; Fan & Chen, 2001). There is a wealth of research on parental participation due to the widespread belief that it positively impacts students' educational performance (Hill & Tyson, 2009; Patal et al., 2008). Research has demonstrated that when parents are actively involved in their children's education, it greatly impacts their academic achievement (Boonk et al., 2018) and the improvement of children's literacy (Cole, 2011). However, studies show that students' low engagement and achievement are associated with parents' lack of involvement or inadequate involvement (Bower & Griffin, 2011). Research by Rowley and Schulenberg (2007) found that early intervention and positive parental involvement were significant predictors of academic performance for children. Tran et al. (2020) found that parental involvement in their children's education substantially influenced their academic achievement. Parents can support their children's learning by assisting with schoolwork, attending school events, engaging in decision-making processes, and maintaining open lines of contact with teachers (Cusinato et al., 2020). Parental involvement helps keep kids in school more frequently, lower dropout rates, and boost academic performance (Emerson et al., 2012). Similarly, only the parents' involvement can promote their children's learning and development (Sk et al., 2019). According to developmental psychologists, parental involvement in education provides "support" for children's growth and boosts children's interest in education (Dogomeo & Aliazas, 2022). Similarly, parents who are actively involved in their children's education are more likely to share information, collaborate on decisions, donate their time, and work alongside teachers to foster their children's growth (Morrison et al., 2011). According to Epstein et al. (2018), parental involvement means that parents are involved in their children's education and consistently show excellent parenting skills. This includes talking to the school staff, volunteering their time at school, helping their children learn at home, being involved in school decisions, and working with the school community on a regular basis. However, Dawadi, 2020; Castro et al., 2015; and Trinick, 2015 have used the term "parental involvement" to describe various actions and procedures that parents may take at home or school. Therefore, parental involvement is defined as parents' commitment and active engagement in both the school and their children's education

Beyond the Schools: How Parental Involvement Affects the Academic Performance of Nepali Public School Students?

(Senge et al., 2012). Khajehpour and Ghazvini (2011) found that parental involvement at home, such as homework review, school-related conversations, or active participation in educational activities, enhances children's academic performance. Studies have demonstrated that when parents are actively involved, their children exhibit better social functioning, develop more consistent approaches to discipline at home and school, do better academically, are more active and ready to learn, and exhibit fewer problem behaviors (Nokali et al., 2010; Sapungan and Sapungan, 2014).

In this study, the term "parent" is broadly defined to encompass all individuals who participate in the upbringing and care of young children. This includes not only parents but also older siblings, grandparents, cousins, and other extended family members. This inclusive definition acknowledges the diverse family structures that are especially prevalent in Nepali contexts, where terms like "involvement," "participation," and "engagement" are often used interchangeably (Hoover-Dempsey & Sandler, 1997; Hornby & Lafaele, 2011). Parents play a critical role in their children's development, serving as their primary educators and mentors. Similarly, Emerson et al. (2012) state, "Parents play an important role in providing learning opportunities at home and in linking what children learn at school with teachers and what happens elsewhere." The shift from traditional to flexible education in the educational system has impacted educators, learners, and parents alike. Parents can help their children by attending school functions, supporting the school, and helping with their academic assignments. They can also assist with the school's assigned work, deliver words of praise, provide a positive study environment, and act as inspiration for morals and conduct (Nisbet, 2021).

Understanding the roles of parents and the nature of parental involvement becomes even more critical when we consider the diverse educational systems globally. Each system has its own distinct characteristics and potential for improvement (Blossing et al., 2014). In the United States, children have access to various educational opportunities, including public, private, religious, and homeschooling programs, along with magnet, charter, online, and vocational schools (Belfield, 2004; Carper, 2001). Similarly, Indonesia's education system includes general, vocational, academic, professional, religious, special, and official education (Septiani, 2023). Publicly sponsored, privately operated, independent schools are becoming prevalent worldwide (Hentschke & Brewer, 2010). However, Nepal's education system is simpler and consists of three main types: public schools, private schools, and religious schools (MoEST, 2021). According to the most recent Flash Report I for the 2021–2022 academic year, Nepal has a total of 34,816 schools, with the government publicly sponsoring approximately 80% and the private sector accounting for the remaining 20% (CEHRD, 2022). In Nepal, the government directly manages and funds public schools (Khanal et al., 2020). The Nepalese Ministry of Education further categorizes public schools into funded public schools, which receive regular government funds for staff salaries and administrative expenses, and unfunded public schools, which rely on community contributions, donations, and other sources of support (Thapa, 2013).

Using quantitative methods, a number of studies have focused on parental involvement in their children's schooling. However, few qualitative studies examine the role of parents in their children's education, particularly in the context of public schools. This research intends to address that knowledge vacuum by investigating how parents in Nepal may motivate their children to succeed academically in public schools. This study aims to explore how parental involvement affects children's academic achievement in one public school in Nepal. The research's specific goal is to investigate the relationship between various forms of parental involvement and students' academic outcomes. It also seeks to identify the various forms of parental involvement within a Nepalese public school setting. To accomplish the purpose of our research, we have posed the following research question:

- a) How does parental involvement affect public school students' academic performance?

Theoretical Perspectives

The theoretical foundation of this study is social capital theory. The term "social capital" refers to the sum of a person's real and potential resources associated with their participation in a group, specifically with their interactions with other group members, whether those relationships are formal or informal. A broader framework of capital consists of social capital, economic capital, cultural capital, and symbolic capital (Bourdieu, 1986). Conversely, Coleman examines social capital through a functionalist lens, emphasizing its usefulness in enabling collective activity and upholding social norms. Coleman (1988) characterizes social capital as a group of entities that originate from social structures and facilitate specific activities of individuals or organizations within those systems.

Coleman's theory emphasizes the advantages of social networks, including trust, information flow, and rules of reciprocity, which facilitate the attainment of shared gains and collective objectives. This expands the idea of social capital beyond the elites to include the powerless and disenfranchised (Coleman, 1988). Coleman (1988) argues that social capital is useful since it facilitates people or groups in accomplishing tasks that would be beyond their individual capabilities. Social capital can be defined as the amalgamation of individual and collective knowledge (McElroy et al., 2006). Links, bridges, and bonds comprise

Beyond the Schools: How Parental Involvement Affects the Academic Performance of Nepali Public School Students?

social capital. Sharing an identity creates bonds. All partners share resources and information through bridges. However, links connect people across social classes (Brian, 2007). According to Dika and Singh (2002), social capital consists of trust, conventions, and networks that empower people to work together for the common good. Supportive interactions between homes, neighborhoods, and educational institutions are an example of social capital in the context of children's growth and development.

METHODOLOGY

We employed a qualitative case study methodology, which involves thoroughly investigating a current occurrence within its real-life setting while examining the relationship between the phenomenon and its context. Furthermore, a case study serves as a research tool and a means to analyze and scrutinize qualitative content (Kohlbacher, 2006). A case study is an empirical investigation that explores a current phenomenon in its actual setting when the distinctions between phenomenon and setting are ambiguous and when various sources of evidence are incorporated (Yin, 1989, p. 23). We adopted the qualitative case study approach to explore a rich, intricate, systematic, and interpretive environment (Stake, 2005). Our study selected a single case study because it addresses real-world issues and offers a comprehensive understanding. We discovered that case studies can assist us in exploring the complex and diverse realities of the respondents (Flick, 2018). A case study, in essence, is an intensive description and analysis of a single individual or group (Yin, 2009).

The research was carried out at a single exemplary public school located in Chitwan, Nepal. Between 2013 and 2023 AD, the school consistently achieved the highest score on the grade ten exam known as SLC and got the SEE excellence award from the federal, provincial, and local authorities. Similarly, between the years 2007 AD and 2022 AD, the case school was the sole public school in the district to consistently rank first in SLC/SEE. Additionally, the bulk of the district's highest-achieving kids exclusively attended the case school. The Case School has consistently received numerous national accolades and recognition from the federal, provincial, and local governments for its active engagement with parents, the community, and the school in various elements of school management, governance, and involvement within the area. An incentive for the top-performing public school that actively engages community stakeholders, including parents, educators, benefactors, and influential figures. In addition, the Case School has received recognition for being the top public school in terms of its collaboration with parents, the community, and the school's program development, implementation, monitoring, and evaluation. During the academic year 2023, the school had a student population of roughly 2600 in kindergarten through grade 12 and a faculty of 180 or more teachers spanning from primary to secondary levels. The SLC/SEE test results have shown exponential growth, with a pass rate of nearly 100% per year from 2013 to 2023.

According to the Ministry of Education (MOE) (2015), the Nepali School Education Examination (SEE), formerly known as the School Leaving Certificate (SLC), is equivalent to the 10th grade. At the end of the tenth grade, students take the School Education Examination (SEE) rather than the School Leaving Certificate (SLC) exam (MoEST, 2019). In Nepal, SLC/SEE is regarded as the most important test. Students in Nepal between the ages of 15 and 16 who have completed ten years of education take the SEE exam, which is given by the SEE examination Board, a constituent body under the Ministry of Education (MOE, 2015). The SLC/SEE exam continues to be accorded a lot of weight.

Table 1: Description of Participants

S. N	Pseudo-name	Sex	Age	Position
1	Tanka	Male	66	Head Teacher
2	Santosh	Male	40	Parent
3	Rita	Female	15	Student
4	Hari	Male	38	Teacher

Purposive sampling was used to choose the samples. Four different types of informants—parent, student, teacher, and head teacher—were chosen, and a sample was included. A semi-structured interview protocol was used for the study. By identifying the respondents by their pseudo-names, reliability has been preserved. We gathered data through in-depth interviews, student observation, and examination of their academic performance. The main components of observation research are participant-administered audio and video recording, diaries, and observer notes.

My data-gathering methods included observation, document reviews, and interviews. My personal reflections on the observations and interview prompted me to create reflective notes. During the data processing procedure, we looked over my own reflections and field notes. We typed in all the information I'd gathered from my research participants. Next, we cross-checked all the transcriptions with the original record to ensure accuracy. We then started a thorough investigation by coding

Beyond the Schools: How Parental Involvement Affects the Academic Performance of Nepali Public School Students?

various subjects or themes (Creswell, 2007). We combined those themes into a narrative so that the conclusions would emerge logically and naturally from the participants' responses and expressions. We verified those themes by comparing them to my field and reflection notes. Throughout the process, we combined and evolved certain concepts that were extremely close to each other into final themes. We then analyzed the data using relevant theories, policies, and literature.

Key Insights and Discussions

We developed the findings and discussion section in accordance with the formulated research question and the purpose of the paper. Four major themes display the findings: a) enhancing children's education through SMC and PTA activities; b) fortifying the parent-teacher bond; c) boosting the home environment in comprehensive education; and d) enhancing school governance and management.

Enhancing Children's Education Through SMC and PTA Activities

All participants in the interview, including the parent, teacher, student, and head teacher, acknowledged that parental involvement in school-related events can enhance the bond between home and school and demonstrate a commitment to their children's education. The study's participants indicated that parental engagement in their children's education through School Management Committees (SMC) and Parent-Teacher Associations (PTA) is crucial in ensuring elevated levels of instructional advancement and enhanced academic performance among pupils. According to multiple studies, parental involvement in school activities, such as joining a PTA or School Management Committee (SMC), positively affects students' academic performance (Zellman & Waterman, 1998; Karsidi et al., 2013). Similarly, Fan and Williams (2010) also claim that by participating in school activities, parents can improve the relationship between the home and the institution and demonstrate how much they care about their kids' education.

According to a high-level National Education Commission report published by MoEST (2019), effective coordination and cooperation between all school stakeholders, including head teachers, SMC members, PTA members, and teachers, could aid in creating a successful and supportive educational environment in public schools. Similar to this, the SSRP program 2009–2016 and Final Report (2016) indicated that improving the accountability and capability of PTAs and SMCs in Nepal's public schools was necessary for ensuring the quality of education provided.

The case school's head teacher claims that the PTA and SMC members were chosen in accordance with the rules. The head teacher, Mr. Tanka, stated that:

We have high parent attendance at every meeting. Monthly meetings on the last Sunday. After reviewing school and student agendas, PTA and SMC members approved the meeting decision and issued the minutes to parents. Our school constantly includes parental feedback in selecting teachers, setting regulations, offering child-oriented teaching and learning tools, and creating a learning environment.

Parental engagement in Nepal's public schools has traditionally been a customary procedure. Factors such as active family involvement, strong parental orientation, parental knowledge, and assistance from the school's management have facilitated the efficient running of the school's agenda. The case school has implemented active PTAs (Parent-Teacher Associations) and SMCs (School Management Committees) to ensure family participation in fostering high-quality education in public schools. This illustrates the policy's substantial impact on the involvement of parents in the management and operation of public schools. According to Bunijevac (2017), schools can greatly benefit from parental involvement because it helps incorporate parents into the educational process, which in turn enhances existing school programs.

In a similar vein, Santosh, a parent, was questioned about how the SMC and PTA came to be.

Child success requires parental love and support. Effective parents safeguard their kids' intellectual development. Neither principals nor instructors should only enhance the academic performance of their students. I joined PTA, school council, etc. to enhance students' performance. A low-income chair was proposed this year. To help our kids flourish, he visited schools regularly and urged parents to attend PTA, SMC, and other parent-teacher conferences. To protect pupils, his group collaborated with school administration and teachers. I supported him at school. Parental policy benefits young people. Parents' inquiries, guidance, and comments improved student performance.

The school rallied parents and established an active SMC, PTA, and other school councils to keep them informed about their children's academic progress, school events, and any problems that may arise. Parental involvement is essential in enhancing school programs, as it cultivates a prosperous learning environment (Bunijevac, 2017). After talking with all four interviewees, I realized that parents' involvement in SMC and PTA significantly contributed to the school's expansion and students' academic achievement. When parents actively participate in school, they invite them to engage in classroom and other activities honestly. Parents have faith in schools when they display honest concern for their children's well-being. Cohn et al. (2019) propose that

Beyond the Schools: How Parental Involvement Affects the Academic Performance of Nepali Public School Students?

honesty plays a crucial role in establishing trust between individuals, which is vital for creating and sustaining social capital. In this way, parents and the school collaborate through SMC and PTA to enhance meaningful participation, guaranteeing students high academic performance. According to Kimaro and Machumu (2015), a strong and meaningful connection exists between parents' involvement in school activities and their children's academic success. Additionally, providing essential school supplies also has a substantial impact on educational outcomes.

Opportunities for parental involvement in their children's education increase their social capital, which is linked to a network of interactions between parents and positively impacts their children's education. Coleman (1988) described social capital as a network of social institutions that serve as informational gateways and enable student achievement. This helps the kids achieve their higher academic goals. I also learned that social capital is linked to the social and intellectual abilities of the parents, enabling their children to learn better as they are routinely monitored in their academic pursuits and learning process.

In my research, I also noticed that parents' social connections enable them to support their kids' education more, giving the kid access to a better educational experience. My finding aligns with the social capital theory that the relationships and links between parents and schools only serve as social capital for educational endeavors. Coleman (1988) argues that social capital is advantageous since it empowers individuals or collectives to accomplish objectives that would otherwise be unattainable alone.

Fortifying the Parent-Teacher Bond

All four interviewees said that the efficacy of communication and collaboration between parents and teachers significantly influenced children's academic performance, conduct, and social growth. The findings indicate that the case school exhibits enhanced parent-teacher connections and relationships, leading to improved school performance and student outcomes. According to Clarke et al. (2010), healthy parent-teacher relationships are those in which both parties recognize the significance of the relationship, work together to build and sustain a positive rapport between the home and the school, and use continuity and reliability across systems to help the child adapt positively. Interaction between teachers and parents is crucial for children to learn, develop, and succeed in school (Washigton, 2011). According to Llamas and Tuazon (2016), there is a strong correlation between the quality of the parent-teacher connection and their children's academic success. Research has shown that parent-teacher interactions are just as important as student-peer relationships regarding academic success. Findings from this study emphasize the value of parent-teacher partnerships by showing that positive, mutually respectful interactions significantly impact adolescents' academic performance (Yu et al., 2023).

Rita, a ninth-grade student, shared a similar experience. She said:

Even though my parents are uneducated, they understand my need for education. My father has always encouraged me to study. He suggested I take more time to think about it. He believes that solid academic credentials are necessary for higher education and a successful profession. My parents knew about my school struggles. My parents collaborated, participated in the school's teacher-parent interaction program, and helped me overcome problems and improve my education by gathering educational resources.

Parent-teacher relationships may affect a student's academic achievement. Parents become more responsible for their children's growth and pay more attention to their learning, activities, and behavior when teachers communicate with them. Students who know their parents and teachers are close and interact often perform better academically. Establishing positive relationships between parents and teachers has a major impact on pupils' academic achievement (Miller et al., 2016). Parents and instructors boost students' academic achievement, personal conduct, and learning through positive relationships. This boosts students' positive attitudes and school enthusiasm. Strong relationships between parents and educators are crucial to a school's growth, just as is the learning community itself (Schussler, 2003).

A parent, Santosh, was questioned regarding the development of the relationship and interaction between parents and teachers in a similar manner. As he stated:

We convey the message through face-to-face interaction. To stay updated about the children, we communicated through various channels, such as phone calls, text messages, and social media. Due to the extensive collaboration and sharing between parents and teachers, we have begun utilizing several mediums to communicate with teachers. If any difficulties arise, the teachers would convene a meeting where we felt comfortable discussing them.

When parents and teachers collaborate, children succeed. Due to mutual respect and trust, shared goals for each student's academic and personal growth, and an environment that encourages discussion, strong parent-teacher relationships are linked to higher student achievement. If school instructors respect and create relationships with parents, parents are more likely to be involved in their children's education. According to Swanson et al., (2010), for the educational process to be successful, the

Beyond the Schools: How Parental Involvement Affects the Academic Performance of Nepali Public School Students?

teachers' and students' parents' cordial connections must be the backbone. Similarly, the presence of consistency in parent-teacher relationships, specifically in shared favorable views, is associated with positive results for children (Minke et al., 2014).

I also discovered that parents' social and intellectual qualities, specifically their close supervision of their children's schoolwork, contribute to social capital. Social capital refers to the amalgamation of individual and collective knowledge (McElroy et al., 2006). Social capital theory also advocates that the relationship between educators and parents creates connections, partnerships, and links supporting children's education (Coleman, 1988).

Boosting the Home Environment in Comprehensive Education

All parties involved, including parents, teachers, students, and the head teacher, emphasized the importance of a nurturing home environment and parental involvement in their children's at-home education. Furthermore, parents who took an active role in their children's education at home understood the need to provide learning opportunities and make connections between classroom instruction and real-world applications. According to Henderson and Berla (1994) and Sanders and Sheldon (2009), all children have a better chance of academic success if they come from an encouraging home environment. Children can mimic the actions of those around them at home. Lehl et al. (2020) found that children's academic performance is influenced by their home learning environment.

A similar experience is shared by a teacher named Hari. He said that

Parents' involvement at home helps children meet their fundamental and learning needs. It aids in creating an environment that is conducive to learning. Despite being literate and illiterate, the parents were aware of the importance of education in their children's lives and tried to assist in any way they could. Parents provided emotional encouragement to all of the students in their endeavors at home.

When his many children helped out around the house, he noticed a marked improvement in their academic performance. He also showcases success stories from a variety of socioeconomic backgrounds. When asked about additional parental aspects that affect their children's academic performance, he emphasized the need to actively participate in the creation of a nurturing household. According to Kamaruddin et al. (2009), there is a positive correlation between pupils' academic achievement, their housing environment, and the motivation of their parents.

He also said that

At our school, the majority of parents create a supportive environment for their children. Students from disadvantaged backgrounds generally face more difficulties compared to students from privileged backgrounds. For example, kids from supportive home situations receive assistance from their parents in completing their homework. This includes assistance with reading and guidance to complete tasks, reducing the workload they have to do independently. Parents also ensure their children's hygiene, offer timely and nutritious meals, supply essential resources upon request, and seek counseling to promote good behavior and academic achievement.

Parents who actively participated in their children's tasks encouraged and nurtured academic excellence (Epstein, 2018). Parental involvement in schooling at home and connecting school lessons to teachers and other events is critical. A child's academic achievement depends on their home environment. According to numerous studies, children who receive parental guidance at home perform better academically (Harris & Godall, 2008). Similarly, according to Lehl et al. (2020), the home learning setting is a positive indicator of how well children will do in school.

Social capital refers to parents' relationships with their children, which influence how well they do in school (Coleman, 1988). As a result, the parent, teacher, student, and head teacher who participated in the interview agreed that maintaining an atmosphere at home conducive to enhanced pupil achievement is crucial. The study's findings demonstrated that students who experience a positive home environment and whose parents actively foster this environment excel in their academic pursuits. According to Melhuish et al. (2008), a greater home learning environment is the largest influence on a child's cognitive development. Parents are excellent sources of real-world wisdom and experience. Parents can participate in their children's education by ensuring they have access to the required learning resources, as social capital suggests.

My finding aligns with social capital theory, highlighting that high parental encouragement and support in a child's education are essential for their academic development (Coleman, 1988). The high parental contribution at home enhances student performance in school (Coleman, 1988).

Enhancing School Governance and Management Better

Research conducted by Shatkin and Gershberg (2007) has demonstrated that when parents and community members actively participate in school governance, it leads to improved school performance and community development. Engaging in this participation can result in enhanced teacher efficacy and learner achievement (Boaduo et al., 2009), and is a fundamental element

Beyond the Schools: How Parental Involvement Affects the Academic Performance of Nepali Public School Students?

of making education more democratic (Parker & Raihani, 2011). All four participants believed that students' academic performance would improve if parents were more actively involved in the school's governance and management process, which includes creating, implementing, evaluating, and reviewing policies, plans, activities, and programs.

The head teacher, Mr. Tanka, stated that

Parental engagement is essential for the school to effectively manage the academic year. Parents who actively engage in school governance enhance the probability that a school will demonstrate transparency and accountability. Consequently, communication among the community, parents, and school has improved. Engaging in planning processes such as the School Improvement Plan (SIP), policy development, and strategy creation enhance the efficiency and effectiveness of resource management in schools. By leveraging their connections and influence, parents can provide financial support and resources to the school. When parents participate in school governance, they can enhance the quality of learning by properly conducting social audits.

Parental participation promotes better cooperation between the school, the community, and the community at large, as well as more transparent and accountable school governance. According to the literature, parents' involvement in their children's school fosters improved parent-school communication and transparent and accountable school governance (Agbo, 2007). Evidence from my research shows that when parents are actively involved in their children's schools, programs like the School Improvement Plan (SIP) and social audits, which aim to boost student achievement, work better. Kimokoti and Kibera (2007) found that a strong correlation exists between a significant degree of parental participation in school governance and the academic achievement of the institution.

A teacher named Hari shares a similar experience:

We invited parents to watch a class at the school. We sought parental counsel and judgment. Parents routinely attended classes to evaluate teaching and learning. Our school will not tolerate parental superiority or other barriers to parental involvement. To boost learning, we collaborated with parents and the community on all school activities.

By involving parents in creating, executing, and evaluating the school's policies, plans, and priorities, school governance can make the school more accountable, forthright, and careful with its results, such as enhancing students' learning. Epstein (2011) asserts that parental participation in school administration and management benefits kids' education and raises their performance. Similarly, academic achievement is positively correlated with parental participation in school governance (Kibera and Kimokoti, 2007). Along with these advantages, it also helps students study more and positively impacts children's social development (Altschul, 2012).

A parent named Santosh shed light on the school's success factor, stating, "*Collaborative efforts among all parents and other stakeholders develop the school's purpose, vision, and objectives. Consider the following as an example: student conduct codes; student assistance funds; school infrastructure improvements; program and facility enrichment; use of information and communication technology; curriculum implementation; and the use of both formal and informal teaching and learning methods to improve students' academic performance.*"

Effective collaboration between parents and school management can lead to enhancements in the school's academic performance. As a result, school administrators must motivate parents to actively engage and contribute towards achieving the school's mission and objectives (Sapungan & Sapungan, 2014). All parties' participation in school matters can facilitate the school's ability to make wise decisions that enhance student achievement (Abebe, 2012). Parental involvement in school governance that is both meaningful and accountable has the potential to improve student achievement and foster growth within the local community (Shatkin & Gershberg, 2007).

According to my findings, schools often seek parental input when developing school improvement plans (SIPs), social audits, and other related policies and strategies. In line with social capital theory, which emphasizes the value of all parents' relationships with the school and one another as social capital, my findings support the idea that these relationships improve educational activities (Coleman, 1988). Warner (2001) asserts that one can cultivate social capital within their local community. Schools are also part of larger communities, so they can do a lot to foster social capital among their students and staff through various interventions. Parents' social capital consists of their relationships within the school and larger communities. The school's efforts to promote social capital will result in stronger ties between parents and community members. These relationships are impacted by how well their kids do in school (Coleman, 1988).

LIMITATIONS

There were a few restrictions on the study. This study utilized the viewpoints of a single parent, a teacher, a student, and the head teacher regarding parental involvement practices. Despite previous research focusing on parents' viewpoints and

Beyond the Schools: How Parental Involvement Affects the Academic Performance of Nepali Public School Students?

impressions, we have questioned the reliability of participants' reported actions compared to their actual actions. Our study's findings are applicable only in the Nepali setting. It has also failed to consider that Nepal is home to a wide range of geopolitical situations. The conclusions are thus not easily generalizable, even though they may hold water in related settings. The most glaring restriction is that data collected from a small sample cannot be used to make inferential or descriptive conclusions. The results of our study suggest that additional research is required to address the numerous issues raised by the gaps that our study did not cover. Despite these caveats, the study fills a gap in the literature by providing a more nuanced picture of the views of parents, educators, students, and principals on the importance of parental participation in high-achieving public schools.

CONCLUSIONS

The active involvement of parents remains crucial in guaranteeing their children's academic achievement in Nepal's public schools. The findings resulted in the parents who attended the school in question showing significant concern and commitment towards their children's academic endeavors. In addition, they made every effort to optimize their children's academic achievement. As a result of the parent's involvement, the case school has performed well over a longer period of time. There is little doubt that children whose families provided them with emotional and physical assistance did better academically. When it comes to improving their children's academic performance, parents who are enhancing their children's education through SMC and PTA activities, fortifying the parent-teacher bond, boosting the home environment in comprehensive education, and enhancing school governance and management employ all possible tactics. Nevertheless, it is imperative for school management to acknowledge the evolving requirements of the educational institution and its children and consequently adapt the practices and policies related to parental involvement in the school. When parents are involved in school events and the school acknowledges and appreciates it, it makes kids feel positive about themselves and makes them want to learn. Parents experience a similar surge of pride and engagement in their children's schooling when they see major improvements in their own academic achievement. Generally speaking, these strategies help improve students' academic performance. Parents' active participation is the only way to improve students' academic performance and the quality of instruction in schools. Solid communication between schools and parents fosters greater participation from parents.

IMPLICATIONS

The importance of parental involvement in increasing academic standards and student accomplishment cannot be overstated. We need to establish a variety of other study areas under parental engagement in education for it to be effective and relevant. Numerous policies have been formulated to encourage parental involvement, yet the policies and the realities do not align. Hence, it seems like a good field for future research to investigate the reasons behind the gap between policy and practice. Schools can also do more to involve parents in their children's education by providing them with opportunities for involvement inside and outside the classroom. Modern educational policies also put parents' involvement in the classroom in the hands of instructors through the formation of committees and the delegation of specific tasks. Therefore, parenting programs, conferences, and workshops with teachers on a regular basis are critical steps in recognizing and exploiting parents' strengths in the classroom and boosting students' academic performance. Furthermore, parents may be an integral and valuable part of their children's education if teachers—and especially the head teacher, who has power—involve them in school activities and collaborate with them.

REFERENCES

- 1) Agbo, S. A. (2007). Addressing school-community relations in a cross-cultural context: A collaborative action to bridge the gap between First Nations and the school. *Journal of Research in Rural Education*, 22(8), 1-14. <http://www.umaine.edu/jrre>
- 2) Altschul, I. (2012). Linking socioeconomic status to the academic achievement of Mexican American youth through parent involvement in education. *Journal of the Society for Social Work and Research*, 3(1), 13-30. <http://doi:10.5243/jsswr.2012.2>
- 3) Belfield, C. R. (2004). Modeling school choice: A comparison of public, private-independent, private-religious and home-schooled students. *Education Policy Analysis Archives*, 12, 30-30. <https://doi.org/10.14507/epaa.v12n30.2004>
- 4) Blossing, U., Nyen, T., Söderström, Å., & Tønder, A. H. (2014). *Local drivers for improvement capacity: Six types of school organisations*. Springer.
- 5) Boaduo, N. A. P., Milondzo, K. S., & Adjei, A. (2009). Parent-Community Involvement in School Governance and Its Effects on Teacher Effectiveness and Improvement of Learner Performance: A Study of Selected Primary and Secondary Schools in Botswana. *Educational Research and Reviews*, 4(3), 96-105.

Beyond the Schools: How Parental Involvement Affects the Academic Performance of Nepali Public School Students?

- 6) Boonk, L., Gijsselaers, H. J., Ritzen, H., & Brand-Gruwel, S. (2018). A review of the relationship between parental involvement indicators and academic achievement. *Educational research review*, 24, 10-30. <https://doi.org/10.1016/j.edurev.2018.02.001>
- 7) Bower, H. A., & Griffin, D. (2011). Can the Epstein model of parental involvement work in a high-minority, high-poverty elementary school? A case study. *Professional School Counseling*, 15(2), 2156759X1101500201. <https://doi.org/10.5330/PSC.n.2011-15.77>
- 8) Bourdieu, P. (1986). The forms of capital. In J. Richardson (Ed.), *Handbook of theory and research for the sociology of education* (pp. 241–258). Westport, CT: Greenwood Press.
- 9) Brian, K. (2007). *OECD Insights Human Capital How what you know shapes your life: How what you know shapes your life*. OECD publishing.
- 10) Bunijevac, M. (2017). Parental involvement as a important factor for successful education. *Center for Educational Policy Studies Journal*, 7(3), 137-153. <https://doi.org/10.26529/cepsj.291>
- 11) Carper, J. C. (2001). The changing landscape of US education. *Kappa Delta Pi Record*, 37(3), 106-110. <https://doi.org/10.1080/00228958.2001.10518478>
- 12) Castro, M., Expósito-Casas, E., López-Martín, E., Lizasoain, L., Navarro-Asencio, E., & Gaviria, J. L. (2015). Parental involvement on student academic achievement: A meta-analysis. *Educational research review*, 14, 33-46. <https://doi.org/10.1016/j.edurev.2015.01.002>
- 13) Centre for Education and Human Resource Development (CEHRD). (2022). *Flash I Report 2078 (2021/22)*. https://cehrd.gov.np/file_data/mediacenter_files/media_file-17-1312592262.pdf
- 14) Clarke, B. L., Sheridan, S. M., & Woods, K. E. (2010). Elements of healthy family-school relationships. In *Handbook of school-family partnerships* (pp. 61-79). Routledge.
- 15) Cohn, A., Marechal, M.A., Tannenbaum, D., & Zund, C.L. (2019). Civic honesty around the globe. *Science*, 365 (6448), 70-73. <https://doi.org/10.1126/science.aau8712>
- 16) Coleman, J. S. (1988). Social capital in the creation of human capital. *American journal of sociology*, 94, S95-S120. <https://doi.org/10.1086/228943>
- 17) Cole, J. (2011). A Research Review: The Importance of Families and the Home Environment. *National Literacy Trust*. <https://files.eric.ed.gov/fulltext/ED521654.pdf>
- 18) Creswell, J. W. (2007). *Qualitative inquiry and research design*. Sage Publication.
- 19) Cusinato, M., Iannattone, S., Spoto, A., Poli, M., Moretti, C., Gatta, M., & Miscioscia, M. (2020). Stress, resilience, and well-being in Italian children and their parents during the COVID-19 pandemic. *International journal of environmental research and public health*, 17(22), 8297. <https://doi.org/10.3390/ijerph17228297>
- 20) Dawadi, S. (2020). Parental involvement in national EFL test preparation. *RELC Journal*, 51(3), 427-439. <https://doi.org/10.1177/0033688219848770>
- 21) Dogomeo, J., & Aliazas, J. V. (2022). Dual coding cognition in devising infographics for an enhanced students' scientific knowledge. *International Journal of Science, Technology, Engineering and Mathematics*, 2(4), 1-17. <https://doi.org/10.53378/352926>
- 22) El Nokali, N. E., Bachman, H. J., & Votruba-Drzal, E. (2010). Parent involvement and children's academic and social development in elementary school. *Child development*, 81(3), 988-1005. <https://doi.org/10.1111/j.1467-8624.2010.01447.x>
- 23) Epstein, J. L., Sanders, M. G., Sheldon, S. B., Simon, B. S., Salinas, K. C., Jansorn, N. R., ... & Williams, K. J. (2018). *School, family, and community partnerships: Your handbook for action*. Corwin Press.
- 24) Epstein, J. L. (2018). School, family, and community partnerships in teachers' professional work. *Journal of Education for Teaching*, 44(3), 397-406. <https://doi.org/10.1080/02607476.2018.1465669>
- 25) Epstein, J. L. (1991). Paths to Partnership: What We Can Learn from Federal, State, District, and School Initiatives. *Phi Delta Kappan*, 72(5), 344-49.
- 26) Fan, X., & Chen, M. (2001). Parental involvement and students' academic achievement: A meta-analysis. *Educational psychology review*, 13, 1-22. <https://doi.org/10.1023/A:1009048817385>
- 27) Fan, W., & Williams, C. M. (2010). The effects of parental involvement on students' academic self-efficacy, engagement and intrinsic motivation. *Educational psychology*, 30(1), 53-74. <https://doi.org/10.1080/01443410903353302>
- 28) Flick, U. (2018). *An introduction to qualitative research*. Sage.

Beyond the Schools: How Parental Involvement Affects the Academic Performance of Nepali Public School Students?

- 29) Gonzalez-DeHass, A. R., Willems, P. P., & Holbein, M. F. D. (2005). Examining the relationship between parental involvement and student motivation. *Educational psychology review*, 17, 99-123. <https://doi.org/10.1007/s10648-005-3949-7>
- 30) Harris, A., & Goodall, J. (2008). Do parents know they matter? Engaging all parents in learning. *Educational research*, 50(3), 277-289. <https://doi.org/10.1080/00131880802309424>
- 31) Henderson, A. T., & Berla, N. (1994). *A new generation of evidence: The family is critical to student achievement*.
- 32) Hentschke, G. C., & Brewer, D. J. (2010). Journal of School Choice Forum on the Global Phenomenon of Publicly Financed, Privately Operated Schools: Common Policy Issues Among Differing Nation States?. *Journal of School Choice*, 4(4), 373-377. <https://doi.org/10.1080/15582159.2010.526836>
- 33) Hill, N. E., & Tyson, D. F. (2009). Parental involvement in middle school: a meta-analytic assessment of the strategies that promote achievement. *Developmental psychology*, 45(3), 740. <https://doi.org/10.1037/a0015362>
- 34) Hoover-Dempsey, K. V., & Sandler, H. M. (1997). Why do parents become involved in their children's education?. *Review of educational research*, 67(1), 3-42. <https://doi.org/10.3102/00346543067001003>
- 35) Hornby, G., & Lafaele, R. (2023). Barriers to parental involvement in education: An explanatory model. In *Mapping the Field* (pp. 121-136). Routledge.
- 36) Kamaruddin, R., Zainal, N. R., Aminuddin, Z. M., & Jusoff, K. (2009). The quality of learning environment and academic performance from a student's perception. *International journal of business and management*, 4(4), 171-175. <https://doi.org/10.5539/ijbm.v4n4p171>.
- 37) Karsidi, R., Humona, R., Budiati, A. C., & Wardoyo, W. W. (2013). Parent involvement on school committees as social capital to improve student achievement. *Excellence in Higher Education*, 4(1), 1-6. <https://doi.org/10.5195/ehe.2013.81>
- 38) Khanal, J., Perry, F., & Park, S. H. (2020). Leadership practices of principals of high-performing community high schools: Evidence from Nepal. *Educational Management Administration & Leadership*, 48(6), 1026-1045. <https://doi.org/10.1177/1741143219884076>
- 39) Khajehpour, M., & Ghazvini, S. D. (2011). The role of parental involvement affect in children's academic performance. *Procedia-Social and Behavioral Sciences*, 15, 1204-1208. <https://doi.org/10.1016/j.sbspro.2011.03.263>
- 40) Kimokoti, A. C., & Kibera, L. W. (2007). *Fundamentals of sociology of education: With reference to Africa*. <http://hdl.handle.net/11295/51060>
- 41) Kimaro, A. R., & Machumu, H. J. (2015). Impacts of parental involvement in school activities on academic achievement of primary school children. *International Journal of Education and Research*, 3(8), 483-494.
- 42) Kohlbacher, F. (2006). The use of qualitative content analysis in case study research. In *Forum qualitative sozialforschung/forum: Qualitative social research* (Vol. 7, No. 1, pp. 1-30). Institut fur Klinische Sychologie and Gemeindesychologie. <https://doi.org/10.17169/fqs-7.1.75>
- 43) Lehl, S., Evangelou, M., & Sammons, P. (2020). The home learning environment and its role in shaping children's educational development. *School Effectiveness and School Improvement*, 31(1), 1-6. <https://doi.org/10.1080/09243453.2020.1693487>
- 44) Llamas, A. V., & Tuazon, A. P. (2016). School practices in parental involvement, its expected results and barriers in public secondary schools. *International Journal of Educational Science and Research*, 6(1), 69-78.
- 45) McElroy, M.W., Jorna, R.J., & van Engelen, J. (2006). Rethinking social capital theory: a knowledge management perspective. *Journal of Knowledge Management*, 10(5), 124-136. <http://dx.doi.org/10.1108/13673270610691233>
- 46) Melhuish, E. C., Phan, M. B., Sylva, K., Sammons, P., Siraj-Blatchford, I., & Taggart, B. (2008). Effects of the home learning environment and preschool center experience upon literacy and numeracy development in early primary school. *Journal of Social Issues*, 64(1), 95-114. <https://doi.org/10.1111/j.1540-4560.2008.00550.x>
- 47) Miller, H., Robinson, M., Valentine, J. L., & Fish, R. (2016). Is the feeling mutual? Examining parent-teacher relationships in low-income, predominantly Latino schools. *American Journal of Education*, 123(1), 37-67. <https://www.journals.uchicago.edu/doi/epdf/10.1086/688167>
- 48) Minke, K. M., Sheridan, S. M., Kim, E. M., Ryoo, J. H., & Koziol, N. A. (2014). Congruence in parent-teacher relationships: The role of shared perceptions. *The elementary school journal*, 114(4), 527-546. <http://www.jstor.org/stable/10.1086/675637>
- 49) Ministry of Education. (2016). *School sector development plan 2016*. Government of Nepal.
- 50) Ministry of Education, Science and Technology. (2021). *Nepal education sector analysis*. Government of Nepal.
- 51) Ministry of Education. (2015). *Nepal education in figure 2015; At a glance*. Department of Education, Kathmandu
- 52) Ministry of Education. (2016). *Final report of SSRP*. Government of Nepal.
- 53) MOEST. (2019). *Nepal High Level National Education Commission*. Government of Nepal.

Beyond the Schools: How Parental Involvement Affects the Academic Performance of Nepali Public School Students?

- 54) Morrison, J. W., Storey, P., & Zhang, C. (2011). Accessible family involvement in early childhood programs. *Dimensions of early childhood*, 39(3), 21-26. <https://eric.ed.gov/?id=EJ945698>
- 55) Nisbet, J. (2021). How parental involvement in education helps children in school. *Prodigy. Blog*. October 6, Available from: <https://www.prodigygame.com/main-en/blog/parental-involvementin-education/>.
- 56) Parker, L., & Raihani, R. (2011). Democratizing Indonesia through education? Community participation in Islamic schooling. *Educational Management Administration & Leadership*, 39(6), 712-732. <https://doi.org/10.1177/1741143211416389>
- 57) Patall, E. A., Cooper, H., & Robinson, J. C. (2008). Parent involvement in homework: A research synthesis. *Review of educational research*, 78(4), 1039-1101. <https://doi.org/10.3102/0034654308325185>
- 58) Sanders, M. G., & Sheldon, S. B. (Eds.). (2009). *Principals matter: A guide to school, family, and community partnerships*. Corwin Press.
- 59) Sapungan, G. M., & Sapungan, R. M. (2014). Parental involvement in child's education: Importance, barriers and benefits. *Asian Journal of Management Sciences & Education*, 3(2), 42-48.
- 60) Schussler, D. L. (2003). Schools as learning communities: Unpacking the concept. *Journal of school leadership*, 13(5), 498-528. <https://doi.org/10.1177/105268460301300501>
- 61) Senge, P. M., Cambron-McCabe, N., Lucas, T., Smith, B., & Dutton, J. (2012). *Schools that learn (updated and revised): A fifth discipline fieldbook for educators, parents, and everyone who cares about education*. Crown Currency.
- 62) Septiani, V. (2023). Types And Levels Of Education In The National Education System In Indonesia. *ATTAQWA: Jurnal Pendidikan Islam dan Anak Usia Dini*, 2(3), 118-125. <https://doi.org/10.58355/attaqwa.v2i3.48>
- 63) Shatkin, G., & Gershberg, A. I. (2007). Empowering parents and building communities: The role of school-based councils in educational governance and accountability. *Urban Education*, 42(6), 582-615. <https://doi.org/10.1177/0042085907305044>
- 64) Sk, R., Banerjee, A., Mishra, R., & Barua, S. (2019). Quality of care and early childhood developmental status in Nepal: a multilevel analysis. *Early Child Development and Care*. <https://doi.org/10.1080/03004430.2019.1570503>
- 65) Stake, R. E. (2005). *Handbook of qualitative research*. Sage.
- 66) Swanson, D. P., Edwards, M. C., & Spencer, M. B. (Eds.). (2010). *Adolescence: Development during a global era*. Academic Press.
- 67) Sy, S. R., Rowley, S. J., & Schulenberg, J. E. (2007). Predictors of parent involvement across contexts in Asian American and European American families. *Journal of Comparative Family Studies*, 38(1), 1a-28. <https://doi.org/10.3138/jcfs.38.1.1a>
- 68) Thapa, A. (2013). Does private school competition improve public school performance? The case of Nepal. *International Journal of Educational Development*, 33(4), 358-366. <https://doi.org/10.1016/j.ijedudev.2012.07.004>
- 69) Tran, T., Hoang, A. D., Nguyen, Y. C., Nguyen, L. C., Ta, N. T., Pham, Q. H., ... & Nguyen, T. T. (2020). Toward sustainable learning during school suspension: Socioeconomic, occupational aspirations, and learning behavior of vietnamese students during COVID-19. *Sustainability*, 12(10), 4195. <https://doi.org/10.3390/su12104195>
- 70) Trinick, T. (2015). Enhancing student achievement: school and community learning partnership. *American Journal of Educational Research*, 3(2), 126-136. <http://pubs.sciepub.com/education/3/2/4/>
- 71) Warner, M. (2001). Building social capital: The role of local government. *The Journal of Socio-Economics*, 30, 187. [https://doi.org/10.1016/S1053-5357\(00\)00105-0](https://doi.org/10.1016/S1053-5357(00)00105-0)
- 72) Washington, A. (2011). *A national study of parental involvement: Its trends, status, and effects on school success*. Western Michigan University.
- 73) Yin, R. K. (2009). *Case study research: Design and methods* (Vol. 5). Sage.
- 74) Yu, X., Wang, X., Zheng, H., Zhen, X., Shao, M., Wang, H., & Zhou, X. (2023). Academic achievement is more closely associated with student-peer relationships than with student-parent relationships or student-teacher relationships. *Frontiers in Psychology*, 14, 1012701. <https://doi.org/10.3389/fpsyg.2023.1012701>
- 75) Zellman, G. L., & Waterman, J. M. (1998). Understanding the impact of parent-school involvement on children's educational outcomes. *The Journal of Educational Research*, 91(6), 370-380. <https://doi.org/10.1080/00220679809597566>



There is an Open Access article, distributed under the term of the Creative Commons Attribution – Non Commercial 4.0 International (CC BY-NC 4.0) (<https://creativecommons.org/licenses/by-nc/4.0/>), which permits remixing, adapting and building upon the work for non-commercial use, provided the original work is properly cited.

Synergizing Fuzzy AHP and MAUT for Integrated Evaluation of PSU Stocks and Mutual Fund Schemes



Veerendra Anchan¹, Sahil Shailendra Vaidya², Ankita Jain³, Rinkle Chaplot⁴

¹Assistant Professor, Anil Surendra Modi School of Commerce, NMIMS University, Mumbai

^{2,3,4}M.Sc. (Finance) Anil Surendra Modi School of Commerce, NMIMS University, Mumbai

ABSTRACT:

Purpose: The paper deals with the financial performance of public sector firms and mutual fund schemes using fuzzy Analytic Hierarchy Process (AHP) for PSU stocks in the BSE PSU Index and fuzzy Multi-Attribute Utility Theory (MAUT) for PSU mutual fund schemes with Assets under Management (AUM) of 1,000 crores and above.

Methodology: We have used fuzzy AHP to analyze the performance of selected PSU stocks on key performance indicators such as EPS, P/E ratio, and Return on Equity. Fuzzy MAUT is used to evaluate the performance of eligible mutual funds over five years.

Findings: High profitability is evident at BEML Ltd whereas ITI yields negative EPS and ROE. ICICI Prudential exhibits strong performance with positive Sharpe as well as Treynor ratios, whereas the Sharpe ratio of most of the other funds is negative. The PSU stock returns along with their corresponding mutual fund returns highlight the significance of performance measures in investing.

Originality: The paper combines ideas from fuzzy logic with traditional financial analysis to create a more balanced approach to evaluating PSU stocks and mutual fund investments.

KEYWORDS: Public Sector Enterprises, Financial Performance, Fuzzy Logic, Analytic Hierarchy Process, Multi-Attribute Utility Theory, PSU Mutual Funds, BSE PSU Index

1. INTRODUCTION

This paper examines the use of multi-criteria decision-making methods in the selection of PSU equities using Fuzzy AHP and in the valuation of banking and PSU mutual fund schemes using Fuzzy MAUT. PSU equities are of great significance to the economy of India, given that PSU equities indicate the interest of the government and therefore are related to the development of infrastructure. The choice of these equities is significant both to institutional investors and individuals. Since share performance qualitative factors and uncertainties indeed necessitate some kind of assessment strategies, funds that pool resources for professional management will help significantly if focus is on government-owned companies with high returns due to market uncertainty. Existing research uses both quantitative and qualitative techniques for investment decision-making, but a gap remains in systematically applying Fuzzy MCDM methods for PSU stock selection and mutual fund appraisal. Fuzzy AHP effectively addresses qualitative ambiguity through hierarchical comparisons and Fuzzy MAUT enriches mutual fund evaluation through measures of within-quality and inter-quality preference. This research works toward doing better in providing a basis for investment decisions by clearing the financial complexities using strategies that satisfy individual risk tolerance and financial goals toward building knowledge regarding public sector investments and mutual fund strategies.

2. LITERATURE REVIEW

According to Aarushi Singh & Sanjay Kumar Malik (2014) "Due to the complexities of decisionmaking in the real world, sophisticated techniques need to be utilized especially when working with the MCDM model. Some of the primary approaches used that are mentioned here include the WSM, AHP, and TOPSIS. Literature review. These approaches complement each other in making it relatively easier to select the most appropriate alternatives following a critical analysis of the qualitative and quantitative dimensions. For instance, in a case involving the selection of a car, the price, design, mileage, and reliability serve to differentiate the otherwise identical options that originate from the same domain. In order to assist choice-makers in navigating

Synergizing Fuzzy AHP and MAUT for Integrated Evaluation of PSU Stocks and Mutual Fund Schemes

the complexities of choice and arriving at well-informed judgments, the MCDM evaluation process is step-wise against these criteria. The capability of MCDM in solving broad science and narrow science problems is best illustrated through its use in areas that include management, transport, and technology. Future Research Innovation, effectiveness, and adaptability are the key requirements for some future MCDM techniques to be applied to various domains of study. Directions, and more so in the light of breakthroughs in computer science. According to Zavadskas & Turskis, (2011) during the last five years, there has been a remarkable rise in research activity in the field of economics. This is with special emphasis on operations research and sustainable development, both of which point towards the growing importance of sound decision-making techniques. The development of Multiple Criteria Decision Making (MCDM) methods, which help in the evaluation and selection of the best options when there is competition in the sense of conflicting preferences between them. At the core of these initiatives are the issues related to the complexities of economic decisions. This literature review focuses on changing the age-old decision-making models to newer models that integrate qualitative criteria with quantitative evaluation. The interplay between individual preferences and the interests of all stakeholders in instituting such structures, the pioneering economists, including Adam Smith and the promises of rational choice theory, emphasize is the concept of constrained rationality, which also helps explain the limits under which humans operate in choice. This indicates that individuals often make choices simple rather than optimal. This can be explained by recent work on stakeholder analysis by von Winterfeldt and Edwards. Then, different considerations may change decisions. The integration therefore underlines the role of MCDM when navigating the complexities of economic decision-making and its ability to create balance among conflicting interests thus well supporting stronger analytical frameworks for further research.

According to Bonissone et al., (2009) The three interconnected elements of Multi Criteria Decision Making (MCDM)—solution search, preference trade-offs, and interactive visualization—are positioned in this research as an integrative framework. In order to find nondominated solutions within the Pareto set—a process made more difficult by non-convexity and nonlinear evaluations—effective search algorithms are essential for navigating complex, high-dimensional solution spaces. The authors discuss the crucial process of preference aggregation at the same time, in which decision-makers express and hone their preferences— which are frequently ill-defined and dynamic—in order to choose the best options. Improvements in Bayesian and fuzzy decision-making techniques have enhanced this element. It is stressed that the interactive visualization process is essential for integrating decisionmakers into the iterative selection and refinement process, enabling them to successfully comprehend and manage trade-offs. The difficulties presented by ambiguity in input data, decision-makers cognitive limits, and the requirement for decision-chain transparency are all highlighted in the study. The authors clarify the usefulness of MCDM approaches and promote further study to increase their applicability to intricate real-world situations by providing a requirement framework and case studies in electric power management, financial portfolio optimization, and air traffic planning. This combination of search, preference, and visualization highlights how MCDM may offer strong answers to complex decision-making problems across a range of fields.

According to Asadabadi et al., (2019) Many firms still prefer intuitive decision-making techniques, though they are given the theoretical benefits of Multi Criteria Decision Making techniques, especially the Analytic Hierarchy Process (AHP) and the Analytic Network Process (ANP). This study reveals a significant discrepancy between the suggested effectiveness of MCDM techniques and their actual use, especially with respect to AHP's intrinsic weaknesses, which include problems with pairwise comparisons and Saaty's constraints. A related study states that decision-makers are more likely to have a hard time forming consistent decisions if there are more criteria; thus, inflated Consistency Ratios and subsequent debates in the accuracy of rankings produced by AHP arise. As a result of the disagreement, decision-makers often change their ratings to achieve artificial cutoff points, which vitiates the authenticity of their selections and nullifies the outcomes. It has also negated empirical research that ensured that the ranking from MCDM is superior to intuitive methods. For example, the researches by Ishizaka and Siraj are negated because the relatively straightforward MCDM can attain rational rankings more than AHP. The results present an urgent necessity for designing more reliable and user-friendly MCDM techniques that are able to circumvent the limitations of traditional methods and thus enhance adoption and confidence among practitioners

According to Bhole, (2018) Multi Criteria Decision Making MCDM: is an important framework to analyse and make decision about choosing the best solutions in varied domains. It applies various techniques such as the Analytic Hierarchy Process AHP and Technique for Order of Preference by Similarity to Ideal Solution are increasingly being applied in real world scenarios, MCDM, with earlier historical roots to utility theory as presented by Von Neumann and Morgenstern in the 1940s. A very rich literature accounts for the usefulness of the MCDM techniques applied in handling complicated decision-making scenarios in all forms, from waste management and financial analysis to infrastructure development and healthcare. Applications in project for example, selection and urban sustainability, have shown that the hybrid methods of which many MCDM methods are hybrids do better in optimizing a solution in addition, the current literature shows that the integrated methods tend to outperform single methodology approaches when there is rivalry among criteria to be appropriately solved, resulting in strengthening the decision-making

Synergizing Fuzzy AHP and MAUT for Integrated Evaluation of PSU Stocks and Mutual Fund Schemes

legitimacy. According to *Moradpour (2021)* multi-criteria decision making (MCDM) models should be used in a complex process of mutual fund performance appraisal to rank funds for evaluation against a number of performance measures. It suggests that an upside potential along with a downside covariance should not be ignored in the performance appraisal. Potential as well as downside risk in performance evaluations by applying the post-modern portfolio theory to set critical performance criteria validated by industry experts. Mutual funds have increased drastically globally, according to the historical trends, and their adoption indicates a shift towards sophisticated investment vehicles in marketplaces characterised by high competition. More recent performance measures like the Sortino ratio have replaced classic benchmarks like the Sharpe ratio, in which risk-adjusted returns is the first priority for comprehensive evaluations. Recent advancements of contemporary models, as Support Vector Machines (SVM) and the PROMETHEE method show just how well these models can rank reliably within Iran's capital market, where traditional methods have become in disrepute due to poor performance. This group of This approach stressed the need for proper adaptation of this holistic approach by the fund managers to cover a wide range of performance measures that would make the investors more transparent and well-informed about their investment decisions. The results would further feed in to augment a comprehensive understanding of mutual fund efficiency through performance appraisal, which eventually leads to the boosting of investor confidence and market competitiveness. To examine criteria and their dependency, *Fazli & Jafari (2012)* proposed a hybrid multiple criteria decision-making (MCDM) model for stock market investments that adopts VIKOR method integrated with the Analytical Network Process (ANP) and DEMATEL. The outcomes identify two champion players and reveal that profitability ratios are of vital importance for investment decisions in the Iranian stock market. *Akbaş & Erbay Dalkılıç, (2021)*, on the other hand, provides a two-stage hybrid approach for portfolio selection that includes fuzzy linear programming and applies the Constrained Fuzzy Analytic Hierarchy Process (Fuzzy AHP) in order to incorporate both quantitative information as well as expert qualitative assessments. Their empirical study of Dow Jones stocks between 2018 and 2020 was characterized to have preferable investing results compared to traditional models addressing investor preferences amid uncertainty. They achieve this using trapezoidal fuzzy numbers, which provide more precision

Varmazyar et al., (2016) argue that for a more apt diagnosis of organizational performance in RTOs, the BSC is increasingly being integrated with MCDM methodologies. This, through techniques such as ANP, DEMATEL, and TOPSIS, for instance, Hybrid approach can improve performance evaluations to incorporate non-financial and financial metrics. Using the intuitionistic fuzzy analytic hierarchy process (IFAHP) of portfolio selection integrating qualitative and quantitative criteria, *Senfi et al., (2024)* illustrate its effectiveness on the Tehran Stock Exchange. When making investing decisions, *Jana et al., (2024)* require financial indices incorporating the Price PEG ratio. Finally, *Alg & Biswas, (2024)* employ fuzzy MCDM frameworks to study stock market responses during the COVID-19 pandemic and observe some resilience in certain global indices. *Elmas et al., (2024)* examined biases among individual investors in Borsa Istanbul and found that regret aversion and overconfidence have a huge impact on investment behavior, with regret aversion most impactful. Investors and overseers may gain from the study through applying the Analytical Hierarchy Process AHP.

Işık et al., (2024) evaluate non-life insurance companies in Turkey by a hybrid model through MAIRCA and Pythagorean Fuzzy AHP. The approach focuses on stock performance and service network, and it, therefore, determined that Halk Sigorta is the most consistent leader. *Alfiana et al., (2024)* concluded that inflation has a negative effect and that there positive correlations with the Jakarta Composite Index. For better investment techniques in the fields of sustainability and risk management *Garcia-Bernabeu et al., (2024)* suggest the use of a multi-objective genetic algorithm which takes into account ESG factors in portfolio optimization.

According to *Vuković et al., (2020)* the comparative study between hybrid multi-criteria decision-making MCDM models and classic Modern Portfolio Theory MPT models of stock selection and portfolio optimization. The aim is to observe how such models, incorporating a much larger set of financial variables, operate in different market conditions and the effects thereof on investment decisions. There also appears to be some weakness in the capability to include aspects of behavior as well as industry-specific information in those models. Future areas for research would be in exploring how insights of behavioural finance can be used better to: The research areas include the psychological influences on investment decisions and the impact of industry-specific characteristics on stock rankings and portfolio performance. For this study, the techniques selected are Analytic Hierarchy Process (AHP) and Simple Additive Weighting (SAW). *(Chen and Ren, 2022)* examine if funds driven by Artificial Intelligence outperform human-managed funds. It finds that the funds powered by AI outperform in stockpicking efficiency and reducing transaction costs significantly due to their superior data analytics capabilities and Reduced behavioural biases. The study indicates that AI funds will perform better than human-managed funds in general but the benefit is not uniform. More comparative research needs to be done on different kinds of market conditions, different types of funds and strategies to fully understand the benefit and limitations of AI. This study made use of the sources from CRSP and COMPUSTAT. *Poklepović & Babić, (2014)* proposed and experimented upon a hybrid multiple criteria A stock selection MCDM approach. To produce one rank of stocks, the approach averages rankings

Synergizing Fuzzy AHP and MAUT for Integrated Evaluation of PSU Stocks and Mutual Fund Schemes

from these distinct MCDM methods— COPRAS, linear assignment, PROMETHEE, SAW, and TOPSIS—using Spearman's rank correlation coefficient. This research aims to reduce a disparity between these methods and the improvement of stock rating accuracy by taking into account, generally those of a financial type and specific factors of an industrial nature. The authors would also like to contribute to the deeper theoretical and empirical knowledge of hybrid MCDM methods and to suggest future developments in integrated methodology.

Atta Mills et al., (2020) presents in this paper a hybrid grey MCDM strategy that combines Analytical Network Process (ANP) and the Decision-Making Trial and Evaluation Laboratory Improvement in the portfolio selection process using the DEMATEL methods Reduce uncertainty and interdependency among criteria for decision-making by facilitating weight and ranking in the grey environment. It discusses and analyses the effectiveness of this hybrid strategy on the Shanghai Stock Exchange, and examines effectiveness and accuracy comparatively against conventional techniques. Instead, it pays specific attention to the necessity for further extension of this approach to other financial markets and asset kinds to ensure its broad application and generalizability. According to *Bimonthly (2019) study by Swati Kumari.* analyses the financial as well as operational performance of Central Public Sector Enterprises (CPSEs) and its subsidiaries of the period 2013 to 2018. The study provides a thorough evaluation of each and every performance-related component of CPSEs for determining the overall impact and effectiveness.

Alptekin's (2009) study assesses the performance of Turkish pension and Type A equity mutual funds from January 2007 to December 2008. The research evaluates the funds using TOPSIS after using performance measuring tools such as Sharpe ratio, Sortino ratio, Treynor index, and Jensen's alpha. Here, it determines which funds are closer to the ideal performance measurements and which are farthest from the negative ideal. This study focuses on the Turkish market but shows that future research might extend to Indian markets, by using several MCDM and MADM methods and also by integrating sector-specific stock selection analysis.

Kanwar and Ghosh's (2023) study analyses the application of Multi-Criteria Decision-Making (MCDM) approaches for ranking sectoral indices at National Stock Exchange (NSE). It analyses the sensitivity of different MCDM approaches, namely CRITIC, SAW, TOPSIS, ARAS, COPRAS, and EDAS, while analysing these indicators. Paper also analyses the impact of "feature weighting" on the performance of the various approaches-precision, scalability, and dependability. It fills this gap by suggesting feature weighting to enhance MCDM approaches and the following studies must be taken into consideration: using higher size datasets, a wider range of indices, and incorporation of machine learning in order to increase their powers of prediction. in economic decision-making. *Cui & Cheng's (2022)* study investigates the use of

Modern Portfolio Theory (MPT) to build trading portfolios in Australia. The project is targeted at constructing an MPT-based trading algorithm that would be useful for acquiring profitable and reliable returns. Major elements influencing the algorithm performance and ways of improving it by overcoming constraints such as limited data and Calculation distortion. Improvement suggestions include using robust methods for the management of missing values, inclusion of explicit data and time varying risk-free rates, user personalization, and study of alternative techniques for portfolio optimization.

According to Senthilkumar et al., (2022) the performance of sector-specific scrips to broadmarket indices in the Indian stock market. It evaluates the portfolios based on sector-specific investment strategies and those that perform better based on broad market indices. Furthermore, the study evaluates the Sharpe Single Index (SIM) model as an alternative to the Modern Portfolio Theory (MPT) model for portfolio optimization. The study identifies a vacuum in existing research, which frequently focuses primarily on MPT while ignoring the potential benefits of sector-specific investments and the SIM model. Future study could look into dynamic weighting, multi-asset class portfolios, causal factors, machine learning integration, and a global viewpoint. *Gupta et al., (2023)* offer a hybrid framework for stock selection in the Indian stock market that combines Bayesian classification, TOPSIS, and Entropy techniques. This framework handles issues such as risk-adjusted ratios and non-normal return distributions. Its goal is to uncover critical elements impacting stock performance and selection while comparing its efficacy to standard portfolio construction techniques. The paper identifies a gap in past research, which frequently ignores the influence of non-normal returns and does not use Bayesian categorization. Future study could expand by incorporating more risk-adjusted ratios, investigating alternative hybrid MCDM methods, and addressing TOPSIS method constraints.

According to Kou et al., (2021) Fintech investments in European banks using a hybrid multidimensional decision-making model. The model combines IT2 fuzzy DEMATEL and IT2 fuzzy TOPSIS to evaluate and rank investment options using financial and non-financial variables. Payment systems and money transfer technologies are among the key investment sectors mentioned, as they improve customer happiness, operational efficiency, and cost reduction. The study emphasizes the necessity for comparative studies across areas, as Fintech practices may differ globally. Future study should broaden the evaluation criteria to include elements such as customer experience, regulatory compliance, and future technology to provide a more complete assessment. The study makes decisions using TOPSIS and sensitivity analysis. *Kiriş & Ustun's (2012)* The research aims to determine the best portfolio composition based on an analysis of stocks from the ISE30 index. However, as this study relies on a single measure, its

Synergizing Fuzzy AHP and MAUT for Integrated Evaluation of PSU Stocks and Mutual Fund Schemes

generalizability might be restricted by the approach. Future study could expand the applicability of the model by including other indexes or market segments around the globe. In addition, the development of clear guidelines on how to apply fuzzy MCDM, like procedures in setting and changing fuzzy parameters, could add more accuracy and interpretability of the stock assessments. The paper focuses on the multi-objective portfolio optimization strategy *According to Bakry et al., (2021)* emphasized the role of Bitcoin in the aspect of portfolio diversification based on traditional optimization techniques, which include equal-weighted and risk-parity techniques. It checks whether Bitcoin is the leading asset in the diversification context compared to the other digital currencies. As per the It might provide deeper information on a more complex or hybrid optimization framework for further study. It also suggests knowledge gaps in the behavior of Bitcoin under extreme market conditions or longer bear markets prevailing. Future studies may be even more complex and use methodologies such as the Black-Litterman model, Conditional Value-at-Risk (CVaR), or multi-objective optimization to better understand Bitcoin's role in portfolio diversification. The study adopted MCDM and CVaR to optimize the portfolio.

3. RESEARCH METHODOLOGY

3.1 Fuzzy AHP:

In today's financial markets, seeking stocks based on strong research can be very much extremely important for Minimizing risk and maximizing rewards: Multi-Criteria Decision Making (MCDM) Techniques are helpful in providing insight into the selection of the best stocks to invest in portfolios, with an increasingly long list of stock appraisal measures. Among these, the Fuzzy Analytical Hierarchy Process (Fuzzy AHP), which deals with subjectivity and ambiguity in the decision-making while studying many quantitative factors for choosing an appropriate stock.

3.1.1: Data Collection:

To provide an analytical review of the risk and financial performance of Public Sector Undertakings (PSUs) in India, data on 59 PSU stocks over several financial parameters are collected. The relevance of these criteria in assessing the performance of stocks and their financial health would lead to their careful selection. An exhaustive dataset containing multiple important Several financial variables have been developed in order to evaluate the financial health and the performance of both the stocks and mutual funds. Such variables are Earnings Per Share (EPS), Price to Earnings Ratio (P/E), Price to Book Ratio (P/B), Price to Sales Ratio (P/S), and Return on Equity (ROE). There are also Standard Deviation, Variance, 5-Year Daily Average Return, and Return on Assets. (ROA) are presented. These have been chosen because of the presence of an already developed relevance for use in financial performance evaluation and company's stock performance. Profitability measures include the use of a firm's EPS (earnings per share) while value ratios encompass the P/E and P/B as measures that assess the valuation of the firm with respect to its book value and earnings, respectively. The P/S ratio is used to analyse the degree of efficiency of revenues. This last set of data adds creation, as well as ROE and ROA, as measures of the company's ability to generate returns on equity and assets, respectively. To add an extra layer of long-term performance risk, Standard Deviation, Variance, and the 5-Year Daily Average Return are included. The data set used is so inclusive; it can form a very good basis for further study and gives insight into the company's financial features of the PSU stocks that are being investigated. This study attempts to gain some valuable insights into the risk characteristics, investment potential, and financial performance of PSU stocks and mutual funds existing in Indian stock exchanges so as to make better selection.

3.1.2 Transposing Data

The raw financial data for all PSU stocks and funds is standardized with much care to Thus, FAHP will definitely be implemented in an effective manner. All the financial ratios and returns would be squared out to balance the calculations ahead. This would entail achieving uniform formatting of the data. Moreover, the FAHP algorithm would process and This would do data with presenting more reliable and accurate fuzzy analysis by harmonic data structure. It was established following the communality among the stocks, which were developed by this Standardization process makes it possible to compare and assess them meaningfully. Accordingly, based on their risk and financial performance.

3.1.3 Fuzzy AHP Matrix Construction

By the consideration of the respective weights of the chosen financial factors, a fuzzy pairwise the evaluation matrix is constructed. To convey the inherent vagueness and uncertainty in human Triangular fuzzy numbers were used in the comparative process for judgment. Fuzzy AHP. For each criterion pair-wise comparison matrices are built by both direct Numerical analysis and sound professional judgment to build a better structure for the relevance ranking of the considered financial elements. The matrices are therefore to fuzzify, TFNs are passed through the comparisons. Fuzzy aggregation Then, there are methods, like the geometric mean method used to aggregate the fuzzy pairwise Combine the comparison matrices into one matrix for each stock. After combining, the centre Then, fuzzy values are defuzzified into crisp values using the ranking method by using an approach. The 59 PSU stocks are graded and ranked according to those very same numbers, which Indicate the relative weights of each financial

Synergizing Fuzzy AHP and MAUT for Integrated Evaluation of PSU Stocks and Mutual Fund Schemes

component. The following is an exhaustive list ranked: It is thus obtained by simply adding the weighted scores assigned to every stock. This gives much-needed Some data on the relative investment attractiveness of stocks, taking into account both the risk It provides an overall profile and their financial performance. More notable and enlightened than more Unlike conventional quantitative approaches, this approach is based on the Fuzzy Analytical End Hierarchy Process (FAHP)—allows decision-makers to make highly informed economic Decisions

Formula for Pairwise Comparison Matrix (A):

$$A = \begin{pmatrix} a_{11} & \dots & a_{1n} \\ \vdots & \ddots & \vdots \\ a_{n1} & \dots & a_{nn} \end{pmatrix} \dots \dots \dots (1)$$

Where a_{ij} is the value from criterion i compared to criterion j and vice versa.

The pairwise comparison values in fuzzy AHP are typically represented by triangle fuzzy numbers (TFNs), denoted as

$$\tilde{a}_{ij} = (l_{ij}, m_{ij}, u_{ij})$$

l_{ij} : Lower bound (minimum possible value).

m_{ij} : Most likely value;

u_{ij} : Upper bound (maximum possible value).

Formula for Fuzzification of the Pairwise Matrix:

$$\tilde{A} = [\tilde{a}_{ij}] = (l_{ij}, m_{ij}, u_{ij}) \dots \dots \dots (2)$$

Aggregation Formula (for Geometric Mean):

$$\tilde{a}_i = \prod_{j=1}^n \tilde{a}_{ij} \dots \dots \dots (3)$$

where \tilde{a}_i is the fuzzy number for each stock, and n is the number of criteria.

Formula for Defuzzification of the Fuzzy Matrix

$$A^* = \frac{l_{ij} + m_{ij} + u_{ij}}{3} \dots \dots \dots (4)$$

Formula for Normalization of Crisp Weights:

$$W_i = \frac{A_i^*}{\sum_{j=1}^n A_j^*} \dots \dots \dots (5)$$

3.2 Fuzzy Multi-Attribute Utility Theory (MAUT):

Fuzzy Multi-Attribute Utility Theory MAUT by utilizing the Multi-Criteria Decision-Making MCDM framework for analysing and ranking the Banking and Public Sector Undertaking. PSU Debt Mutual Funds. Applying fuzzy logic, the proposition is to consider the intrinsic

Subjectivity and vagueness permeate financial appraisals and allow for much more refined assessments of Investment opportunities. The structured approach proposed involves a fuzzy decision matrix, Normalizing Performance Indicator, Computation of Criterion Weights, and Calculation of Aggregate Ranking scores. This approach attempts to offer the investor a comprehensive It links quantitative and qualitative assessment, enhancing more complex decision making in this fast-changing investment world.

3.2.1 Information Collection:

Information garnered for this study was obtained from top financial websites that host Money Control, aside from the specific websites of individual mutual funds. The emphasis has been Only in Banking and PSU Debt Fund schemes, truly forming the bedrock of risk return profiles in the emerging market landscape. Beginning with, based on there were 21 schemes identified. On their market presence, the choice has come down to 15 schemes which meet the on an absolutely basis of a threshold of ₹ 1000 crores AUM. This cut-off had that were established to ensure that only sufficiently large and stable funds were analysed, thereby Enhance Relevance and Validity of the Outcomes of All Performance Measures Identified for the study is, therefore scrutinized to

Synergizing Fuzzy AHP and MAUT for Integrated Evaluation of PSU Stocks and Mutual Fund Schemes

authenticate its significance in the making of decisions. It is for processes so they can appropriately capture the financial health and risk profile of every fund.

3.2.2 Fuzzy matrix construction:

These are then included in a fuzzy decision matrix for the next step in the analysis. the desired performance measures. The following matrix attempts a very rough outline of Every mutual fund scheme's performance compared against the given criteria. The decision matrix A fuzzy deal with innate uncertainties and variabilities presents in financial data. framework. It is important because in practice all financial measures are always approximated and Subjective, therefore, it requires a flexible decision-making paradigm that indeed reflects the intricacies of mutual fund reviews.

3.2.3 Normalization of the Fuzzy Matrix:

The fuzzy matrix is such that for equitable comparison across different performance indicators. normalized values acquired using min-max scaling method. The process transfers every to a common scale, which makes the comparison of data much easier. The normalized It also finds the score value for each criterion based on the minimum of scores. and extrema for that objective function. The normalization procedure is important, because it providing a solid platform for analysis, hence enabling subsequent decision-making procedures.

Formula for Normalization of the Fuzzy Matrix:

To obtain the normalized score (N) for each performance metric (j) and scheme (i), follow these steps:

$$N_{ij} = \frac{(X_j) - \min(X_j)}{\text{Max}(X_{ij}) - \min(X_j)} \dots \dots \dots (6)$$

Where;

- X_{ij} is the original score of schemes i for metric j
- Min (X_j) is the minimum score for metric j across all schemes.
- Max (X_{in}) is the maximum score for metric j across all schemes.

3.2.4 Weight Calculation:

All performance parameters assigned a respective weight that results from the value viewed in terms of mutual fund performance review. The weights are derived using the N-Rank formula, which is a combination of the total number of criteria and the rank assigned to each individual criterion. This ranking incorporates quantitative measures along with qualitative information; it thus forms a hierarchy of performance metrics: Sharpe Ratio, Jensen's Alpha, Treynor Ratio, Average 10-Year Return, Beta, Standard Deviation, Assets Under Management (AUM), and Expense Ratio. This hierarchical rating thus conveys each metric's relative importance for the overall performance and suitability of mutual fund schemes and its alignment with investor objectives and risk tolerance.

Formula for Weight Calculation

The N-Rank formula is used to calculate the weight (W) for each performance metric (j). Each criterion is assigned a rank (R_j) and the total number of criteria (n). Weight is calculated as:

$$W_j = \frac{n - R_j + 1}{\sum_{k=1}^n n - R_k + 1} \dots \dots \dots (7)$$

Where:

- n is the total number of performance metrics.
- R_j is the rank assigned to metric j

3.2.5 Aggregate Score Calculation and Ranking:

Aggregation of scores for every scheme of mutual funds through multiplication of normalized values by respective weights marks the final step in the calculation process. This computation method evaluates the overall performance of each fund by summing the strengths of that fund across all chosen performance criteria into a single quantitative score. Using aggregate scores, the mutual fund schemes are rated so that the potential investor could make judgments that are well-informed and based on a holistic understanding of mutual fund performance dynamics. This provides an organized process that not only improves the reliability of the performance assessment but also helps in reducing the ambiguity sometimes connected with financial evaluations.

Synergizing Fuzzy AHP and MAUT for Integrated Evaluation of PSU Stocks and Mutual Fund Schemes

The aggregate score S_i for each scheme "I" is computed as follows:

$$S_i = \sum_{j=1}^m N_{ij} \cdot W_j \dots \dots \dots (8)$$

Where; N_{ij} is the normalized score for scheme i for metric j W_j is the weight assigned to performance metric j m is the total number of performance metrics.

4. RESULTS AND INTERPRETATION:

4.1 PSU Stocks:

The dataset gives the insight into several financial parameters about several organizations, and some reveals a considerable variation in the key performance indicators such as EPS, P/E ratio, P/B ratio, and ROE. For instance, BEML Ltd shows a very high EPS of 67.96 and a ROE of

11%, which means strong profitability and effective usage of equity. On the contrary, ITI's -5.8 EPS and -27.80% ROE are warning signs of critical operational inefficiencies and pending financial troubles. The P/E ratios vary in a very wide range-from a rather too high 922 from Bharat Heavy Electricals to a minimum of 6.05 at Canara Bank-which points towards market values and differing perceptions that investors have regarding future growth prospects.

Table I: Calculation of Fuzzy TFN Matrix (Source: Author Generated)

	EPS	P/E	P/B	P/S	ROE	ROA	DAILY AVERAGE RETURN	S.D	VARIANCE	L	M	U
EPS	(1,1,1)	(3,4,5)	(2,3,4)	(2,3,4)	(4,5,6)	(3,4,5)	(3,4,5)	(2,3,4)	(2,3,4)	2.28 9428	3.09 3171	3.86 3968
P/E	(1/5,1/4,1/3)	(1,1,1)	(1,2,3)	(1,2,3)	(3,4,5)	(2,3,4)	(2,3,4)	(1,2,3)	(1,2,3)	1.10 2163	1.73 7073	2.34 6901
P/B	(1/4,1/3,1/2)	(1/3,1/2,1)	(1,1,1)	(1,2,3)	(2,3,4)	(1,2,3)	(1,2,3)	(1,2,3)	(1,2,3)	0.81 9481	1.36 079	1.98 8452
P/S	(1/4,1/3,1/2)	(1/3,1/2,1)	(1/3,1/2,1)	(1,1,1)	(2,3,4)	(1,2,3)	(1,2,3)	(1,2,3)	(1,2,3)	0.00 6173	0.44 4444	1.75 9955
ROE	(1/6,1/5,1/4)	(1/5,1/4,1/3)	(1/4,1/3,1/2)	(1/4,1/3,1/2)	(1,1,1)	(2,3,4)	(1,2,3)	(1,2,3)	(1,2,3)	0.54 3916	0.79 9413	1.27 6518
ROA	(1/5,1/4,1/3)	(1/4,1/3,1/2)	(1/3,1/2,1)	(1/3,1/2,1)	(1/4,1/3,1/2)	(1,1,1)	(1,2,3)	(1,2,3)	(1,2,3)	0.48 1414	0.72 5313	1.09 4287
DAILY AVERAGE RETURN	(1/5,1/4,1/3)	(1/4,1/3,1/2)	(1/3,1/2,1)	(1/3,1/2,1)	(1/4,1/3,1/2)	(1/4,1/3,1/2)	(1,1,1)	(1,2,3)	(1,2,3)	0.41 2689	0.59 438	0.89 6747
S.D	(1/4,1/3,1/2)	(1/3,1/2,1)	(1/3,1/2,1)	(1/3,1/2,1)	(1/4,1/3,1/2)	(1/4,1/3,1/2)	(1/3,1/2,1)	(1,1,1)	(1,1,1)	0.38 6598	0.48 7083	0.79 3701
VARIANCE	(1/4,1/3,1/2)	(1/3,1/2,1)	(1/3,1/2,1)	(1/3,1/2,1)	(1/4,1/3,1/2)	(1/4,1/3,1/2)	(1/3,1/2,1)	(1,1,1)	(1,1,1)	0.38 6598	0.48 7083	0.79 3701

Synergizing Fuzzy AHP and MAUT for Integrated Evaluation of PSU Stocks and Mutual Fund Schemes

This data table provides an overall comparison of several financial metrics using paired comparison methods to derive relative importance weights across key performance indicators like Earnings Per Share (EPS), Price-to-Earning (P/E) ratio, Price-to-Book (P/B) ratio, Priceto-Sales (P/S) ratio, Return on Equity (ROE), Return on Assets (ROA), daily average return, standard deviation (S.D.), and variance. Each of the measures is assessed using a set of comparative pairs that result in a hierarchical framework highlighting the interdependence and relative weight of each financial measure. Those weights actually illustrate a well-defined hierarchy, and EPS, P/E, and ROE therefore constitute three performance indicators that are important for companies, while P/B and P/S ratios together with variance and standard deviation as a means of measurement of risk can be read in a meaningful way, setting the context for volatility and the valuation of firms at the market. This multi-factor approach not only facilitates more nuanced interpretation of the results but also provides strategic insight into where one should and should not invest because it explains the underlying financial health and future growth possibilities of the companies comprising this study.

Table II: Calculation of Crisp Weights of PSU Stocks (Source: Author Generated)

Sr. no	Fuzzy geometric mean	Fuzzy Weights	Fuzzy Weight addition	Weights	Normalised weights (Crisp Values)
1	[2.289, 3.093, 3.863]	[0.355,0.318,0.261]	0.935668	0.311	0.31
2	[1.102, 1.737, 2.346]	[0.171,0.178,0.158]	0.507221	0.169	0.17
3	[0.819, 1.360, 1.988]	[0.127,0.139,0.134]	0.401642	0.133	0.13
4	[0.006, 0.444, 1.759]	[0.0009,0.045,0.118]	0.165266	0.055	0.06
5	[0.543, 0.799, 1.276]	[0.084,0.082,0.086]	0.253105	0.084	0.08
6	[0.481, 0.725, 1.094]	[0.074,0.074,0.073]	0.223057	0.074	0.07
7	[0.412, 0.594, 0.896]	[0.064,0.061158,0.060]	0.185685	0.061	0.06
8	[0.386, 0.487, 0.793]	[0.060,0.050,0.053]	0.163658	0.054	0.05
9	[0.386, 0.487, 0.793]	[0.060,0.050,0.053]	0.163658	0.054	0.05
				0.999	1.00
Geometric mean Summation	Geometric mean Reciprocal				
6.428	0.155				
9.728	0.102				
14.814	0.067				
	[0.155, 0.1027, 0.0675]				

The relative weights of several financial criteria in rating corporate performance are illustrated through the analysis of crisp weights generated from fuzzy geometric means. Fuzzy geometric means represent the condensed expert evaluation for each statistic from EPS to Variance, while fuzzy weights derived from these means denote the relative priorities assigned by experts. In this manner, a hierarchy is uncovered in their contribution towards the general rating of performance.

Normalized crisp weights, the ratios of each metric's fuzzy weight divided by total fuzzy weight, are easily read and applied. There is, for example, the highest normalized weight assigned to EPS in the investment decision-making process, which shows that its importance is most critical, while measures such as S.D. and Variance have relatively smaller weight values, meaning they have a smaller impact in the setting. It prioritizes metrics in a way that stakeholders focus on the most important financial indicators. Results show not only the systematic rigor of applying fuzzy logic to financial analysis but also its use in turning hard judgments into actionable insights, hence improving strategic investment decisions and risk management techniques.

The investment stocks were chosen from the overall cumulative scores that reflected a comprehensive analysis of key financial performance parameters. The top companies within the list highlighted BEML Ltd, Bharat Heavy Electricals Limited, Cochin Shipyard, Gujarat Gas, Hindustan Aeronautics, Indian Bank, LIC of India, Mazagaon Dock Shipbuilders, Power Finance Corporation, and State Bank of India. With aggregate scores so high, these companies have sound fundamentals in metrics such as Earnings Per Share (EPS), Price-to-Earnings (P/E) ratio, and Return on Equity (ROE). One should keep in mind that the approach of such

Synergizing Fuzzy AHP and MAUT for Integrated Evaluation of PSU Stocks and Mutual Fund Schemes

analysis focuses on the fact that they happen to be quite potential appealing investment possibilities for those 'smart' investors searching for an improved portfolio performance.

4.2 Banking & PSU Mutual Fund Schemes:

Major banking and PSU debt funds are reviewed based on the risk-adjusted returns as well as overall investment acceptability. Important financial criteria include standard deviation, beta, Sharpe ratio, Jensen's alpha, Treynor's ratio, expense ratio, assets under management, and average 10-year returns.

This analysis of banking and PSU debt funds shows huge variation in performance parameters that signifies an environment of risk, return, and efficiency with differing degrees. The standard deviations express different volatility, HSBC is the highest danger, whereas beta values signify more market vulnerability. Negative Sharpe ratio prevalence threatens risk-adjusted returns, however, but ICICI Prudential presents at positive Sharpe and Treynor ratio which seems to reflect good management of the market risks.

If we are to make some judgement on Jensen's alpha, we can say that HSBC is able to offer more returns. However, expense ratios range from 0.41% to 0.81%, thus suggesting that cost management should be one critical factor in determining which fund to choose. Of course, investors must consider their risk appetite and their specific investment goals as they navigate this rather complex world; in any case, ICICI Prudential looks like a pretty compelling offer at a time when conditions are generally difficult.

Table III: Fuzzy Matrix of Banking & PSU Mutual Fund Schemes Having AUM More than 1000 Crores (Source: Author Generated)

Scheme Name	Standard Deviation (l, m, u)	Beta (l, m, u)	Sharpe Ratio (l, m, u)	Jensen's Alpha (l, m, u)	Treynor's Ratio (l, m, u)	Expense Ratio (l, m, u)	AUM (l, m, u)
Aditya Birla Sun Life Banking & PSU Debt Fund	(0.0, 0.27, 0.44)	0.18, (0.0, 0.27)	0.22, (0.0, 0.75)	0.24, (0.0, 1.0)	0.62, (0.0, 1.0)	0.29, (0.0, 0.65)	0.15, (0.0, 1.0)
Axis Banking & PSU Debt Fund	(0.0, 0.18, 0.27)	0.06, (0.0, 0.09)	0.10, (0.0, 0.75)	0.16, (0.0, 0.57)	0.57, (0.0, 0.78)	0.29, (0.0, 0.65)	0.15, (0.0, 1.0)
Bandhan Banking & PSU Debt Fund	(0.0, 0.27, 0.36)	0.18, (0.0, 0.21)	0.10, (0.0, 0.75)	0.24, (0.0, 0.43)	0.57, (0.0, 0.78)	0.29, (0.0, 0.65)	0.15, (0.0, 1.0)
DSP Banking & PSU Debt Fund	(0.25, 0.36, 0.44)	0.12, (0.0, 0.16)	0.22, (0.0, 0.75)	0.40, (0.0, 0.43)	0.78, (0.0, 1.0)	0.20, (0.0, 0.50)	0.15, (0.0, 1.0)
HDFC Banking & PSU Debt Fund	0.09, (0.0, 0.18)	0.18, (0.0, 0.21)	0.12, (0.0, 0.75)	0.20, (0.0, 0.43)	0.78, (0.0, 1.0)	0.35, (0.0, 0.78)	0.15, (0.0, 1.0)
HSBC Banking and PSU Debt Fund	0.64, (0.5, 0.72)	1.0, (0.9, 1.0)	0.0, (0.0, 0.75)	1.0, (1.0, 1.0)	0.0, (0.0, 0.5)	0.35, (0.0, 0.78)	0.15, (0.0, 1.0)
ICICI Prudential Banking & PSU Debt	0.27, (0.0, 0.36)	0.0, (0.0, 0.18)	0.44, (0.0, 0.75)	0.16, (0.0, 0.43)	0.0, (0.0, 0.5)	0.29, (0.0, 0.65)	0.15, (0.0, 1.0)

Synergizing Fuzzy AHP and MAUT for Integrated Evaluation of PSU Stocks and Mutual Fund Schemes

Fund							
Kotak Banking and PSU Debt Fund	0.18, (0.0, 0.27)	0.0, (0.0, 0.0)	0.0, (0.0, 0.75)	0.16, (0.0, 0.43)	0.0, (0.0, 0.5)	0.29, (0.0, 0.65)	0.15, (0.0, 1.0)
LIC MF Banking & PSU Fund	0.18, (0.0, 0.27)	0.12, (0.0, 0.12)	0.10, (0.0, 0.75)	0.16, (0.0, 0.43)	0.0, (0.0, 0.5)	0.29, (0.0, 0.65)	0.15, (0.0, 1.0)
Nippon India Banking & PSU Debt Fund	0.18, (0.0, 0.27)	0.0, (0.0, 0.12)	0.0, (0.0, 0.75)	0.16, (0.0, 0.43)	0.0, (0.0, 0.5)	0.29, (0.0, 0.65)	0.15, (0.0, 1.0)
SBI Banking and PSU Fund	0.27, (0.0, 0.36)	0.12, (0.0, 0.15)	0.0, (0.0, 0.75)	0.24, (0.0, 0.43)	0.0, (0.0, 0.5)	0.0, (0.0, 0.5)	0.15, (0.0, 1.0)
Sundaram Banking & PSU Fund	0.36, (0.0, 0.45)	0.12, (0.0, 0.15)	0.0, (0.0, 0.75)	0.24, (0.0, 0.43)	0.0, (0.0, 0.5)	0.0, (0.0, 0.5)	0.15, (0.0, 1.0)

This kind of fuzzy matrix analysis of Banking and PSU loan funds reveals that there is an inherent variability and uncertainty in such important performance criteria that are represented as triangle fuzzy numbers (l, m, u). The standard deviations revealing large changes in returns range from (0.90, 1.00, 1.30) to (1.50, 1.70, 1.80). The same funds-creating a fuzziness-and higher the-beta values-HSBC also has the highest beta values-reveal increased exposure to systematic risk-which are exposed mostly to volatile returns. Notably, the prevalence of negative Sharpe ratios among numerous funds highlights insufficient risk-adjusted returns, with ICICI Prudential emerging as a possible anomaly. Jensen's alpha variability demonstrates varying capacities for generating excess returns, which are exacerbated by mostly negative Treynor ratios, indicating issues in systematic risk management. While expense ratios remain reasonably stable (0.30% to 0.90%), demonstrating the need of cost efficiency, consistent AUM statistics indicate strong investor confidence, albeit moderated by liquidity concerns. Overall, this fuzzy matrix methodology provides a sophisticated lens through which investors can negotiate the complexity of risk and return in the Banking and PSU debt fund sector.

Table IV: Normalized Matrix of Banking & PSU Mutual Fund Schemes Having AUM More Than 1000 Crores (Source: Author Generated)

Scheme Name	Standard Deviation (l, m, u)	Beta (l, m, u)	Sharpe Ratio (l, m, u)	Jensen's Alpha (l, m, u)	Treynor's Ratio (l, m, u)	Expense Ratio (l, m, u)	AUM (l, m, u)
Aditya Birla Sun Life Banking & PSU Debt Fund	0.18, (0.0, 0.27, 0.44)	0.18, (0.0, 0.27)	0.22, (0.0, 0.75)	0.24, (0.0, 1.0)	0.62, (0.0, 1.0)	0.29, (0.0, 0.65)	0.15, (0.0, 1.0)
Axis Banking & PSU Debt	0.18, (0.0, 0.27)	0.06, (0.0, 0.09)	0.10, (0.0, 0.75)	0.16, (0.0, 0.57)	0.57, (0.0, 0.78)	0.29, (0.0, 0.65)	0.15, (0.0, 1.0)

Synergizing Fuzzy AHP and MAUT for Integrated Evaluation of PSU Stocks and Mutual Fund Schemes

Fund								
Bandhan Banking & PSU Debt Fund	(0.0, 0.27, 0.36)	(0.0, 0.21)	0.18, 0.10,	(0.0, 0.75)	(0.0, 0.43)	0.24, 0.57,	(0.0, 0.78)	0.29, 0.15,
DSP Banking & PSU Debt Fund	(0.25, 0.36, 0.44)	(0.0, 0.16)	0.12, 0.22,	(0.0, 0.75)	(0.0, 0.43)	0.40, 0.78,	(0.0, 1.0)	0.20, 0.15,
HDFC Banking & PSU Debt Fund	(0.0, 0.09, 0.18)	(0.0, 0.21)	0.18, 0.12,	(0.0, 0.75)	(0.0, 0.43)	0.20, 0.78,	(0.0, 1.0)	0.35, 0.15,
HSBC Banking and PSU Debt Fund	(0.5, 0.64, 0.72)	(0.9, 1.0)	1.0, 0.0,	(0.0, 0.75)	(1.0, 1.0)	1.0, 0.0,	(0.0, 0.5)	0.35, 0.15,
ICICI Prudential Banking & PSU Debt Fund	(0.0, 0.27, 0.36)	(0.0, 0.18)	0.0, 0.44,	(0.0, 0.75)	(0.0, 0.43)	0.16, 0.0,	(0.0, 0.5)	0.29, 0.15,
Kotak Banking and PSU Debt Fund	(0.0, 0.18, 0.27)	(0.0, 0.0)	0.0, 0.0,	(0.0, 0.75)	(0.0, 0.43)	0.16, 0.0,	(0.0, 0.5)	0.29, 0.15,
LIC MF Banking & PSU Fund	(0.0, 0.18, 0.27)	(0.0, 0.12)	0.12, 0.10,	(0.0, 0.75)	(0.0, 0.43)	0.16, 0.0,	(0.0, 0.5)	0.29, 0.15,
Nippon India Banking & PSU Debt Fund	(0.0, 0.18, 0.27)	(0.0, 0.12)	0.0, 0.0,	(0.0, 0.75)	(0.0, 0.43)	0.16, 0.0,	(0.0, 0.5)	0.29, 0.15,
SBI Banking and PSU Fund	(0.0, 0.27, 0.36)	(0.0, 0.15)	0.0, 0.12,	(0.0, 0.75)	(0.0, 0.43)	0.24, 0.0,	(0.0, 0.5)	0.0, 0.15,
Sundaram Banking & PSU Fund	(0.0, 0.36, 0.45)	(0.0, 0.15)	0.12, 0.0,	(0.0, 0.75)	(0.0, 0.43)	0.24, 0.0,	(0.0, 0.5)	0.0, 0.15,

The normalized matrix for Banking and PSU debt funds elucidates key performance and risk characteristics, revealing that most schemes have moderate volatility, with standard deviations typically ranging from (0.0, 0.27, 0.44), indicating return stability.

Synergizing Fuzzy AHP and MAUT for Integrated Evaluation of PSU Stocks and Mutual Fund Schemes

Notably, HSBC has higher volatility (0.5, 0.64, 0.72) and beta values (0.9, 1.0, 1.0), indicating increased market sensitivity and an aggressive risk profile. While Sharpe ratios reflect a range of risk-adjusted returns, with certain funds, such as ICICI Prudential, showing encouraging statistics (up to 0.44, 0.75), others show insufficient risk compensation. Jensen's alpha shows that HSBC outperforms in terms of excess returns, and Treynor ratios support this trend by emphasizing its superior systematic risk-adjusted performance. With relatively low expense ratios improving their appeal and significant AUM figures signalling investor confidence. The determined weights for each criterion represent their relative importance in the evaluation framework used to measure investment performance. The Sharpe Ratio appears as the most important indicator, with a weight of around 0.222, emphasizing its importance in balancing risk and reward. Jensen's Alpha and Treynor's Ratio, with a weighting of 0.194 and 0.167 respectively, are crucial in assessing both relative performance to a benchmark and return per unit of systematic risk. The average 10-year return, which carries a weight of 0.139, underscores the significance of past success as a guide for future investment selections. Meanwhile, Beta, Standard Deviation, AUM, and Expense Ratio have been assigned weights that have decreased cumulatively, indicating that even though each plays a part in the final rating, they are subservient to the performance-focused metrics. This hierarchically weighted approach therefore allows the creation of differentiated interpretation of the investment alternatives, thereby guiding the direction of investment decisions based on simple key performance indicators critical to maximizing investor returns while efficiently dealing with risk.

The aggregate scores for the Banking and PSU debt funds, as outlined below, are based on the following top five performers, in order:

1. Bandhan Banking & PSU Debt Fund possesses high Jensen's Alpha, hence promises a prospect for more than market returns and excellent performance indicators.
2. DSP Banking & PSU Debt Fund: The fund provides competitive, risk-adjusted returns, which demonstrate its success in risks management, and profits making.
3. HDFC Banking and PSU Debt Fund: HDFC offers spectacular balanced return, achieving such an outstanding risk-reward profile that, it is a very reliable product for investors.
4. ICICI Prudential Banking & PSU Debt Fund has performed well, which shows good management and subsequent scope for growth in the industry.
5. Sundaram Banking & PSU Fund ranks fifth and has an aggregate score going well with it.

It is a good fund for stability with acceptable return.

The rankings pose a critical need for a sophisticated assessment of risk and return measures to guide informed investment decisions in the banking and public sector.

5. LIMITATIONS OF THE PAPER

- Lack of Qualitative Appraisals: almost exclusively used quantitative measurements, so we could not derive much insight from market movements and investor mood.

- Only Five Years Time-span: The analysis of the performance data only covered a five-year time span, and therefore we were limited into just the depth of insights that we could gather.

There are other important variables not included in this model that could affect performance, for example, growth of the GDP, inflation, and interest rates. Macroeconomic Variables Excluded.

- Methodology Subjectivity: Their findings could be affected, perhaps even in terms of ranks and repeatability, due to the subjectivity introduced by using fuzzy AHP and MCDM.

6. CONCLUSION & DISCUSSION

This study gives a comprehensive and in-depth analysis of the financial characteristics of public sector firms and mutual fund schemes, which clearly brings out the gigantic and huge difference in the performing indicators and underlines the need for a detailed investment appraisal. EPS and ROE of BEML Ltd are quite strong, whereas the ITI shows negative indicators; quite clearly bring out the colossal operational problems that lead to taking the service seriously with deep financial analysis. The utilization of fuzzy logic, in conjunction with the methodology of pairwise comparison, facilitates a systematic decision regarding the relative importance of key financial indicators so stakeholders may make better strategic decisions.

Banking and PSU mutual fund scheme research shows an array of risk and return profiles. ICICI Prudential works well for a strong contender based upon great Sharpe and Treynor ratios that indicate good procedures in place for risk management. Its hierarchical framework of evaluation points out performance-centric measures to a large extent and asks investors to keep in mind the attention of their risk-adjusted returns keeping their specific risk tolerance levels at bay.

Synergizing Fuzzy AHP and MAUT for Integrated Evaluation of PSU Stocks and Mutual Fund Schemes

Other future research that extends from this research involves qualitative judgments, besides incorporating macroeconomic data and market sentiment indicators, into the framework to generate a more holistic investment framework. A larger dataset encompassing a wider range of organizations and mutual funds could strengthen and generalize the findings. Besides, longitudinal studies, which track the performance of specific stocks and funds over successive periods of time, would also give interesting information on the long-term sustainability of their financial health and growth rate.

Advanced machine learning algorithms to project the real-time performance of stocks and funds based on historical data and current market patterns may provide real-time insights with flexible strategies responding to changing market conditions. On their own, the impact of regulatory amendments to the performance of public sector firms and mutual funds can offer better understanding regarding the intricacies of the sector.

Finally, continuous research efforts in these directions would help bring more refined investment strategies and decision-making processes to the investors working through the intricacies of public sector investments, making the capital allocation more resilient and with better information.

REFERENCES

- 1) Alfiana, A. *et al.* (2024) 'Analysis Of The Effect Of Macroeconomic Variables On Returns Of Mutual Fund Shares Traded At State Owned Bank', *JEMSI (Jurnal Ekonomi, Manajemen, dan Akuntansi)*, 10(1), pp. 223–228. Available at: <https://doi.org/10.35870/jemsi.v10i1.1898>.
- 2) Alg, C. and Biswas, S. (2024) 'Computational Algorithms and Numerical Dimensions www.journal-cand.com A Fuzzy Compromise Solution Framework for Assessing the Early Effect of COVID-19 on Global Stock Indices Citation', *Num. Dim*, 3(4), pp. 252–276. Available at: <https://doi.org/10.22105/cand.2024.475801.1108>.
- 3) Alptekin, N. (2009) 'PERFORMANCE EVALUATION OF TURKISH TYPE A MUTUAL FUNDS AND PENSION STOCK FUNDS BY USING TOPSIS METHOD', *INTERNATIONAL JOURNAL OF ECONOMICS AND FINANCE*, 1(2).
- 4) Asadabadi, M.R., Chang, E. and Saberi, M. (2019) 'Are MCDM methods useful? A critical review of Analytic Hierarchy Process (AHP) and Analytic Network Process (ANP)', *Cogent Engineering*, 6(1). Available at: <https://doi.org/10.1080/23311916.2019.1623153>.
- 5) Atta Mills, E.F.E. *et al.* (2020) 'A hybrid grey MCDM approach for asset allocation: Evidence from China's Shanghai stock exchange', *Journal of Business Economics and Management*, 21(2), pp. 446–472. Available at: <https://doi.org/10.3846/jbem.2020.11967>.
- 6) Bakry, W. *et al.* (2021) 'Risk and Financial Management Bitcoin and Portfolio Diversification: A Portfolio Optimization Approach'. Available at: <https://doi.org/10.3390/jrfm>.
- 7) Bhole, G.P. (2018) 'Multi Criteria Decision Making (MCDM) Methods and its applications', *International Journal for Research in Applied Science and Engineering Technology*, 6(5), pp. 899–915. Available at: <https://doi.org/10.22214/ijraset.2018.5145>.
- 8) Bimonthly, E. (no date) 'JAMSHEDPUR RESEARCH REVIEW YEAR 7 Volume 2 Issue 33', *Jamshedpur Research Review-Govt. Regd., Refereed, Peer Reviewed* [Preprint]. Available at: www.jamshedpurresearchreview.com.
- 9) Bonissone, P.P., Subbu, R. and Lizzi, J. (2009) 'Multicriteria decision making (MCDM): A framework for research and applications', *IEEE Computational Intelligence Magazine*, 4(3), pp. 48–61. Available at: <https://doi.org/10.1109/MCI.2009.933093>.
- 10) Chen, R. and Ren, J. (2022) 'Do AI-powered mutual funds perform better?', *Finance Research Letters*, 47. Available at: <https://doi.org/10.1016/j.frl.2021.102616>.
- 11) Cui, Y. and Cheng, C. (2022) 'Modern Portfolio Theory and Application in Australia', *Journal of Economics, Business and Management*, 10(2), pp. 128–132. Available at: <https://doi.org/10.18178/joebm.2022.10.2.686>.
- 12) Elmas, B., Demir, B. and Aydın, S. (2024) 'Analysis of Behavioral Biases Affecting Investment Decisions of Individual Investors using Analytical Hierarchy Process', *Trends in Business and Economics*, 38(3), pp. 138–146. Available at: <https://doi.org/10.16951/trendbusecon.1506923>.
- 13) Fazli, S. and Jafari, H. (2012) 'Developing a hybrid multi-criteria model for investment in stock exchange', *Management Science Letters*, 2(2), pp. 457–468. Available at: <https://doi.org/10.5267/j.msl.2012.01.011>.
- 14) Garcia-Bernabeu, A. *et al.* (2024) 'ESG integration in portfolio selection: A robust preferencebased multicriteria approach', *Operations Research Perspectives*, 12. Available at: <https://doi.org/10.1016/j.orp.2024.100305>.
- 15) Gupta, S. *et al.* (2023) 'AN INTEGRATED FRAMEWORK FOR CLASSIFICATION AND SELECTION OF STOCKS FOR PORTFOLIO CONSTRUCTION: EVIDENCE FROM NSE, INDIA', *Decision Making: Applications in Management and Engineering*, 6(1), pp. 774–803. Available at: <https://doi.org/10.31181/dmame0318062021g>.

Synergizing Fuzzy AHP and MAUT for Integrated Evaluation of PSU Stocks and Mutual Fund Schemes

- 16) Işık, Ö., Çalık, A. and Shabir, M. (2024) 'A Consolidated MCDM Framework for Overall Performance Assessment of Listed Insurance Companies Based on Ranking Strategies', *Computational Economics* [Preprint]. Available at: <https://doi.org/10.1007/s10614-024-105785>.
- 17) Jana, S. *et al.* (2024) 'Application of Fuzzy AHP in Priority Based Selection of Financial Indices: A Perspective for Investors', *Economics*, 12(1), pp. 1–27. Available at: <https://doi.org/10.2478/eoik-2024-0007>.
- 18) Kiriş, Ş. and Ustun, O. (2012) 'An integrated approach for stock evaluation and portfolio optimization', *Optimization*, 61(4), pp. 423–441. Available at: <https://doi.org/10.1080/02331934.2011.644285>.
- 19) Kou, G. *et al.* (2021) 'Fintech investments in European banks: a hybrid IT2 fuzzy multidimensional decision-making approach', *Financial Innovation*, 7(1). Available at: <https://doi.org/10.1186/s40854-021-00256-y>.
- 20) Moradpour, N. (2021) 'Ranking Mutual Funds Performance Based on Post-modern Portfolio Theory Indicators Using Multi-Criteria Decision-Making Methods', *International Journal of Management, Accounting and Economics*, 8(1). Available at: www.ijmae.com.
- 21) Poklepović, T. and Babić, Z. (2014) *Stock selection using a hybrid MCDM approach*, *Croatian Operational Research Review*. Available at: <http://www.hdoi.hr/corr-journal>.
- 22) Senfi, S., Sheikh, R. and Sana, S.S. (2024) 'A portfolio selection using the intuitionistic fuzzy analytic hierarchy process: A case study of the Tehran Stock Exchange', *Green Finance*, 6(2), pp. 219–248. Available at: <https://doi.org/10.3934/GF.2024009>.
- 23) Senthilkumar, A., Namboothiri, A. and Rajeev, S. (2022) 'Does portfolio optimization favor sector or broad market investments?', *Journal of Public Affairs*, 22(S1). Available at: <https://doi.org/10.1002/pa.2752>.
- 24) Singh, A. and Kumar Malik, S. (2014) *Major MCDM Techniques and their application-A Review*. Available at: www.iosrjen.org.
- 25) Varmazyar, M., Dehghanbaghi, M. and Afkhami, M. (2016) 'A novel hybrid MCDM model for performance evaluation of research and technology organizations based on BSC approach', *Evaluation and Program Planning*, 58, pp. 125–140. Available at: <https://doi.org/10.1016/j.evalprogplan.2016.06.005>.
- 26) Vuković, M., Pivac, S. and Babić, Z. (2020) 'Comparative analysis of stock selection using a hybrid MCDM approach and modern portfolio theory', 6(2), pp. 58–68. Available at: <https://doi.org/10.1515/crebss>.
- 27) Zavadskas, E.K. and Turskis, Z. (2011) 'Multiple criteria decision making (MCDM) methods in economics: An overview', *Technological and Economic Development of Economy*, 17(2), pp. 397–427. Available at: <https://doi.org/10.3846/20294913.2011.593291>.



There is an Open Access article, distributed under the term of the Creative Commons Attribution – Non Commercial 4.0 International (CC BY-NC 4.0) (<https://creativecommons.org/licenses/by-nc/4.0/>), which permits remixing, adapting and building upon the work for non-commercial use, provided the original work is properly cited.

Prevalence, Morphological Classification, and Factors Associated With Severe Anemia among Children Under 5 Years of Age at Itojo Hospital



Adjira UMUKWIYE Masters¹, Sylvestre HAVUGIMANA Masters², Bernard Natukunda Phd³, Elysee HITAYEZU Masters⁴, Theoneste HAGENIMANA Masters⁵

¹Department of Medical Laboratory Sciences ; Faculty of Health Sciences, Mount Kigali University, P.O. Box 5826, Kigali -Rwanda.

² Department of Agricultural Engineering; Rwanda Polytechnic-Karongi College, P.O. Box 85 Kibuye-Rwanda

³Department of Medical Laboratory Sciences, Faculty of Medicine, Mbarara University of Science and Technology, P. O. Box 1410, Mbarara, Uganda.

⁴Kibogora Polytechnic, Faculty of Health Sciences and Biomedical Laboratory Sciences Department, Western Province Po.Box 50 Nyamasheke

⁵Student Affairs, Rwanda Polytechnic-Karongi College, P.O.Box 85 Kibuye- Rwanda

ABSTRACT: The study sought to establish the prevalence, morphological classifications, and factors associated with severe anemia among children attending Itojo Hospital. A hospital-based cross-sectional study design was used in this study in which children aged less than 5 years who attended the pediatric ward at Itojo Hospital were involved. Patients were consecutively recruited until a sample size of 296 was obtained. Data were collected from patients' caregivers with a structured questionnaire. Data analysis was done using SPSS Version 20.0. Descriptive statistics and bivariate and multivariate logistic regression were used during data analysis. Multiple logistic regression models were used to show the strength of the relationship and the likelihood that each of the factors would lead to severe anemia among children under 5 years. Of the 296 patients enrolled, the prevalence of severe anemia was 13.9%. The Majority of the patients (50.7%) had microcytic anemia, followed by 32.8% with normocytic anemia. Factors that were significantly associated with severe anemia were the age of the child ($P=0.029$), HIV/AIDS ($P=0.000$), leukemia ($P=0.000$), and sickle cell disease ($P=0.000$). The prevalence of severe anemia among children less than five years of age was found to be relatively high hence increasingly becoming a public health problem. There is a need for age-specific interventions that comprehensively address the issue of improved nutrition, prevention, and management of HIV infection as well as chronic and genetic disorders.

KEYWORDS: Anemia, Anemia classes, Prevalence, Children under 5 years.

1. INTRODUCTION

The global prevalence of anemia is estimated to be 42.6%, and its magnitude in Children varies across the World and where in Africa, South East Asia, America, and European regions is 62.3%, 53.8%, 23.3%, and 22.9%, respectively (Alem et al., 2013). Globally, on average, around 9.6 million children of severe anemia, Africa, has a high prevalence of 62.3% (Rahmati, Delpisheh, Parizad, & Sayehmiri, 2016). Several reports suggested anemia rates ranging between 71% and 79% in Kenya, South Africa, and Tanzania (Foote et al., 2013). The burden of anemia among under-5-year-old children in Uganda was reported to be 67.5% (Kikafunda, Lukwago, & Turyashemerwa, 2009).

According to Elsayid, Al-Qahtani, Alanazi, & Qureshi (2015), the morphological classification of anemia depends on nutritional deficiencies, parasitic infections, blood loss, bone marrow replacement, or suppression and hemoglobinopathies. Then arbitrarily, anemia may be classified as either moderate (7.0-10.0 g/dl) or severe (Elsayid et al., 2015). The most common cause of anemia in young children is low consumption and absorption of iron-rich foods (i.e., meat and meat products) (Black et al., 2013). In developing countries, the most common cause of Anemia is poor nutritional practices (B. Singh, Singh, Kaur, & Singh, 2016).

Prevalence, Morphological Classification, and Factors Associated With Severe Anemia among Children Under 5 Years of Age at Itojo Hospital

In terms of morphological presentations, it is believed that a tilt in balance in the production and senescence of erythrocytes, either red cell underproduction, excessive destruction, or both, triggers anemia. (Longo et al., 2012). Almost all anemias are associated with abnormalities in the size, shape, color, distribution, or intracytoplasmic content of the red cells (Jones, 2009). Given that the reference range for mean red cell volume (MCV) is 80-95 femtoliter, (Perkins, 2006) red cell size less than 6 micrometers and MCV less than 0fl is termed microcytic (Ademola & Abiola, 2016) which is associated with macrocytic anemia cases.

The different factors associated with severe anemia are lack of awareness of anemia in parents/guardians coupled with their low educational status, poor nutritional practices, unhealthy food habits, a diet with low iron bioavailability, and malaria and parasitic infestations (Kikafunda et al., 2009).

Among the well-described consequences of anemia are impaired physical growth, immune alterations and increased susceptibility to infection, impaired motor development leading to reduced cognitive ability (Santos et al, 2009), poor school performance, and short or long-term mortality in acute severe cases (Legason, et al., 2017).

In Rwanda, the prevalence of anemia among children under 5 years old was 36.2 in 2016 (WHO, 2017). In 2010, among the 38.1% of the children aged 6-59 anemic months, 24.2 had mild, 13.5% had moderate anemia and 0.5 had severe anemia (Nshimiyiryo et al., 2019). These last researchers reported that in the year 2014-2015, among the 36.5% of the anemic children, 20.8% had mild, 15% had moderate, and 0.7% had severe anemia.

Despite multi-sectoral efforts to reduce the burden of anemia in Uganda, the prevalence of anemia was 53% in children aged 6-59 months, up from 49% in 2011 (Uganda Bureau of Statistics–UBOS and ICF, 2018). The burden of anemia among under 5 years old children in Uganda was reported to be 67.5%. However, this varies with different districts, that is 58.8% in Namutumba District (Tropical Laboratory Medicine, 2018) and 26.2% in Bushenyi District (Ocan et al., 2018).

Ewusie, et al., (2014), declared that although the prevalence of anemia decreased, it only reduced with an increase in age meaning that children were still in danger of being anemic. The exception was in Karamoja with an 8% prevalence (UNICEF Uganda, 2018) and this increase needs to be subjected to research, but the possible reasons could be difficulty in food reaching this region due to wars and their nomadic lifestyle (Adebisi et al, 2019). Thus the study was aimed at determining the prevalence, morphological classifications, and factors associated with severe anemia among children aged less than 5 years attending Itojo Hospital in Ntungamo District, Uganda.

2. MATERIALS AND METHODS

2.1 Study site

The study was carried out in the pediatric Ward and Hospital laboratory at Itojo Hospital, Ntungamo District, Southwestern Uganda. The geographical coordinates of Itojo Hospital are 0°47'16.0"S, 30°16'38.0" E (Latitude: -0.787778; Longitude:30.277222). The hospital has a bed capacity of 120, although sometimes many more patients are admitted, with many sleeping on the floor.

2.2 Anemia diagnosis techniques

2.2.1 Blood samples collection

The samples were collected from 296 Children under 5 years admitted to the pediatric ward with identifiable signs and symptoms of anemia.

2.2.2 Complete blood count (CBC)

A Complete blood count (CBC) machine called Mindray BC 6200 automated hematology analyzer was used to count the number of blood cells in a sample of the patient's blood.

2.3 Anemia classification determination

Microscopy was used where thick and thin blood smears were prepared to detect the presence of hemoparasites, stained using Giemsta stain, and examined for the observation of red blood cell morphology to enable in classifying type of anemia and staining properties.

2.4. Risk factors assessment

2.4.1 Stool analysis

The freshly collected stool samples from the study participants were analyzed both macroscopically and microscopically using the direct technique with the help of saline, iodine, eosin, and concentration using formal ether to detect the intestinal parasites.

2.4.2 Questionnaires

Prevalence, Morphological Classification, and Factors Associated With Severe Anemia among Children Under 5 Years of Age at Itojo Hospital

The structured questions were one way to investigate the risk factors associated with severe anemia. The mothers or caregivers/guardians of the listed children were convinced and requested to participate in the study.

Data analysis

SPSS version 20.0 was used in descriptive statistics and logistic regression analysis to determine the significance of the factors associated with severe anemia, with a level of significance at 0.05.

3. RESULTS AND DISCUSSION

3.1 The severity of anemia and its prevalence among Children under 5 attending Itojo Hospital

The majority of the patients had mild anemia (48.6%), followed by moderate at 30.4% with the least having severe anemia at 13.9% (Fig 1).

The proportion of patients who have severe anemia was 41 out of the total of 296 patients within the pediatric ward at Itojo Hospital. This consequently makes a prevalence of 13.9% of patients with severe anemia (Fig 2).

As far as the prevalence of severe anemia was concerned, it was evident that the prevalence of severe anemia was higher among children at 13.9 percent. The prevalence in our study findings is lower than that mentioned in a study by Engidaye et al. (2019), which established that of the total anemic hospitalized children 225 from Gondar, Northwest Ethiopia, 20.9% had severe anemia. Contrary, the results are higher compared to the study of Nambiema, (2019) in which the prevalence of severe anemia among children aged from 6 to 59 months in Togo was 2.6%. In a study carried out by Ocan et al. (2018) at Saint Mary's Hospital Lacor, Gulu District, Northern Uganda on Prevalence, morphological characterization, and associated factors of anemia among children below 5 years, the prevalence of severe anemia was 11.9%, which is lower than findings in our study but they quite similar. The prevalence in our study is higher compared to the study by Kuziga et al. (2017), whereby the proportion of children who had severe anemia was as low as 1.3% among children under five years. The observed differences in the prevalence of severe anemia were probably due to differences in the education level of parents, availability of adequate and nutritious food, and knowledge of nutrition among children under five years.

3.2 Morphological classification of anemia

The majority of the patients (50.7%) had microcytic anemia, followed by 32.8% with normocytic anemia and the least 16.6% with macrocytic anemia. The reticulocyte count was found to be normal (Table 1).

Table 1: Morphological classification of anemia

Variable	Category	Freq./%age
Microcytic	Yes	150 (50.7)
	No	146 (49.3)
Normocytic	Yes	97 (32.8)
	No	199 (67.2)
Macrocytic	Yes	49 (16.6)
	No	247 (83.4)

This finding corroborated with results from a study done in Serbia (Djokic et al., 2010). The higher proportion of microcytic anemia was possibly attributed to the presence of parasitic infections such as hookworms and inflammatory diseases such as leukemia as reported in our study.

Nearly half of the anemia cases in childhood are due to iron deficiency as reported by Gebreweld et al. (2019). This deficiency may result from inadequate dietary intake of iron, malabsorption of iron (Gebreweld et al., 2019). In this study, the cause of the microcytic anemia is likely iron deficiency since most of the anemic children were unable to access food some of which would be rich in iron.

Normocytic anemia according to Janus and Moerschel (2010) is normally caused by hemolytic anemia (e.g. malaria), hereditary spherocytosis, and early or partially treated iron or vitamin deficiency.

3.3 Factors associated with severe anemia among children attending Itojo Hospital

Prevalence, Morphological Classification, and Factors Associated With Severe Anemia among Children Under 5 Years of Age at Itojo Hospital

In bivariate analysis using the Chi-square test, factors that were significantly associated with severe anemia were the age of the child ($P=0.029$), income level of parents ($P=0.051$), parents' education ($P=0.024$), malaria ($P=0.025$), HIV/AIDS ($P=0.000$), leukemia ($P=0.000$) and sickle cell disease ($P=0.000$) (Table 2).

Table 2: Results of Multivariate analysis of factors associated with severe anemia

Variable	Adjusted OR (95% CI)	P value
Age of the child		
0-2 years	1.0	0.031
3-5 years	0.468(0.235-0.934)	
Income level		
Below 8000sh daily	1.0	0.060
8000-12,000sh daily	2.3 (0.797-6.354)	
More than 12,000sh daily	2.7 (0.960-7.712)	
Parents' education		
Primary	1.0	0.067
Secondary	2.7 (0.933-7.586)	
Tertiary	3.9(1.396-10.904)	
Malaria		
Yes	1.0	0.068
No	0.5 (0.230-0.919)	
HIV		
Yes	1.0	0.000
No	0.11 (0.053-0.239)	
Leukemia		
Yes	1.0	0.000
No	0.03 (0.014-0.076)	
Sickle cell disease		
Yes	1.0	0.000
No	0.08 (0.038-0.165)	

Variable(s) entered on step 1: Age of the child, income level of parents, parents' education, malaria, leukemia, and sickle cell disease.

Patients who were aged between 3-5 years were less likely to have severe anemia compared to patients who were aged 0-2 years OR = 1.0, (95%CI: 0.47 (0.235-0.934), $P= 0.031$). Malaria was not a significant predictor of severe anemia $P=0.068$).

Likewise, HIV-negative patients are less likely to have severe anemia compared to the HIV-positive (OR= 0.11, 95%CI: 0.053-0.239, $P = 0.000$).

Furthermore, patients who did not have leukemia were less likely to be associated with severe anemia compared to those who had it (OR= 0.03, 95%CI: 0.014-0.076, $P = 0.000$).

Patients who did not have sickle cell disease were less likely to suffer from severe anemia compared to those who had sickle cell disease (OR =0.08, 95%CI: 0.038-0.165, $P= 0.000$).

The findings are quite similar to an epidemiological investigation in Iran by Mohammadi et al.(2019) which reported that the older age of children was a protective factor for childhood anemia, and the risk of anemia decreased by 12% with the rise of one month of age. A further study conducted by Li et al. (2020) in Ethiopia found that the risks of anemia in age groups of 6–11 months and 12–23 months were 5.67 and 5.80 times more than those of the age group of 48–59 months, respectively. The higher number of children in the 0-2 years age group being more at risk of severe anemia was partly attributed to low immunity, hereditary diseases, and vulnerability to parasitic infections.

Prevalence, Morphological Classification, and Factors Associated With Severe Anemia among Children Under 5 Years of Age at Itojo Hospital

HIV was also significantly associated with severe anemia under multivariate analysis whereby HIV-negative patients were less likely to have severe anemia compared to HIV-positive ($P=0.000$). The findings are in agreement with a study by Owiredu et al, (2011) that anemia is a common comorbid condition among HIV-infected children and has a profound impact on disease progression and has been noted as a significant predictor of decreased survival time and death. Relatedly, Gotlib, (2011), found that children are more prone to the consequences of anemia due to high iron requirements, low intake of iron from foods, and frequent episodes of infection.

Leukemia remained a statistically significant predictor of severe anemia among anemic children under 5 years after being subjected to multivariate analysis ($P=0.000$). Sickle cell disease also had a statistically significant association with severe anemia under multivariate analysis ($P=0.000$). The findings are in agreement with those of Muoneke & Chidilbekwe, (2011), who found a significant association between sickle cell disease and severe anaemia in Nigeria. Children with sickle cell disease are susceptible to infections which may result in a rapid fall of haemoglobin levels. Magalhaes & Clements, (2011), also established that the risk factors for anemia vary in different settings; and include hematological malignancies and chronic diseases like sickle cell disease (SCD).

CONCLUSION

Our study concluded that the prevalence of severe anemia among children less than five years of age is relatively high. Hence it is increasingly becoming a public health problem in the study area especially among children aged 6–23 months who were more likely to be anemic compared to those older in the 24–59 months' age group. The most common morphological type of anemia was microcytic anemia among Hospital-admitted children under 5 years. It was evident that the age of the child, HIV, leukemia, and sickle cell disease were the factors significantly associated with severe anemia. Thus there is a need for age-specific interventions that comprehensively address the issue of improved nutrition, prevention and management of HIV infection as well as chronic and genetic disorders.

DECLARATION OF COMPETING INTEREST

The authors have declared that no conflicts of interest exist.

ACKNOWLEDGMENTS

The authors would like to acknowledge the support from Itojo Hospital laboratory.

AUTHOR CONTRIBUTIONS

A.U: Conceptualization; Investigation; Methodology; Data analysis; Writing and supervision; **S.H & T.H:** Original draft; Writing review; editing & **B.N& E.U:** Review, editing; supervision

FUNDING

This research did not receive any specific grant from funding agencies

REFERENCES

- 1) Ademola, A. S., & Abiola, O. A. (2016). Morphologic Evaluation of Anemia-I. *Biology and Medicine*, 8(6), 1.
- 2) Anlaakuu, P., & Anto, F. (2017). Anemia in pregnancy and associated factors: a cross-sectional study of antenatal attendants at the Sunyani Municipal Hospital, Ghana. *BMC research notes*, 10(1), 402.
- 3) Avelyn, G. (2014). The relationship between prenatal self-care practices during pregnancy and birth outcomes among young mothers aged 16 to 24 years delivering at Gweru Maternity Hospital.
- 4) Blumenstock, J., Cadamuro, G., & On, R. (2015). Predicting poverty and wealth from mobile phone metadata. *Science*, 350(6264), 1073-1076.
- 5) Chattha, M. N., Mazhar, M. I., Hasan, T., Rai, M. E., & Waqas, K. (2018). SEVERE ANEMIA. *The Professional Medical Journal*, 25(05), 664-668.
- 6) Donahue Angel, M., Berti, P., Siekmans, K., Tugirimana, P. L., & Boy, E. (2017). Prevalence of iron deficiency and iron deficiency anemia in the northern and southern provinces of Rwanda. *Food and Nutrition Bulletin*, 38(4), 554-563.
- 7) Elsayid, M., Al-Qahtani, A. M., Alanazi, A., & Qureshi, S. (2015). Determination of the most common morphological patterns of anemia among Saudi anemic patients attending King Abdul-Aziz Medical City-Riyadh. *International Journal of Medicine and Public Health*, 5(4).

Prevalence, Morphological Classification, and Factors Associated With Severe Anemia among Children Under 5 Years of Age at Itojo Hospital

- 8) Gebreweld, A., Ali, N., Ali, R., & Fisha, T. (2019). Prevalence of anemia and its associated factors among children under five years of age attending at Guguftu health center, South Wollo, Northeast Ethiopia. *PLoS One*, 14(7).
- 9) Kozycki, C. T., Umulisa, N., Rulisa, S., Mwikarago, E. I., Musabyimana, J. P., Habimana, J. P., . . . Krogstad, D. J. (2017). False-negative malaria rapid diagnostic tests in Rwanda: impact of Plasmodium falciparum isolates lacking hrp2 and declining malaria transmission. *Malaria journal*, 16(1), 123.
- 10) Lopez, A., Cacoub, P., Macdougall, I. C., & Peyrin-Biroulet, L. (2016). Iron deficiency anemia. *The Lancet*, 387(10021), 907-916.
- 11) Mghanga, F. P., Genge, C. M., Yeyeye, L., Twalib, Z., Kibopile, W., Rutalemba, F. J., & Shengena, T. M. (2017). Magnitude, severity, and morphological types of anemia in hospitalized children under the age of five in Southern Tanzania. *Cureus*, 9(7).
- 12) Nshimiryo, A., Hedt-Gauthier, B., Mutaganzwa, C., Kirk, C. M., Beck, K., Ndayisaba, A., . . . El-Khatib, Z. (2019). Risk factors for stunting among children under five years: a cross-sectional population-based study in Rwanda using the 2015 Demographic and Health Survey. *BMC Public Health*, 19(1), 175.
- 13) Rahmati, S., Delpisheh, A., Parizad, N., & Sayehmiri, K. (2016). Maternal anemia and pregnancy outcomes: A systematic review and meta-analysis. *International Journal of Pediatrics*, 4(8), 3323-3342.
- 14) Singh, S., & Parihar, S. (2019). Prevalence of anemia in under five-year-old children: a hospital-based study. *International Journal of Contemporary Pediatrics*, 6(2), 842.
- 15) Woldie, H., Kebede, Y., & Tariku, A. (2015). Factors associated with anemia among children aged 6–23 months attending growth monitoring at Tsitsika Health Center, Wag-Himra Zone, Northeast Ethiopia. *Journal of nutrition and metabolism*, 2015.
- 16) Tropical Laboratory Medicine. Department of Clinical Sciences. Preparation of thin blood films and Giemsa staining. TLM_PRO_026 Version No.001; 2018.
- 17) Ocean A, Oyet C, Webbo F, Mwambi B, Taremwa, I.M., (2018). Prevalence, morphological characterization, and associated factors of anemia among children below 5 years of age attending St. Mary’s Hospital Lacor, Gulu District, Northern Uganda.
- 18) Adebisi, Y. A. et al (2019). Prevalence and Socio-economic Impacts of Malnutrition Among Children in Uganda. *Nutrition and Metabolic Insights* Volume 12: 1–5.
- 19) Scott, SP, Chen-Edinboro LP, Caulfield LE, Murray-Kolb LE. The impact of anemia on child mortality: an updated review. *Nutrients*. 2014; 6(12):5915–5932.

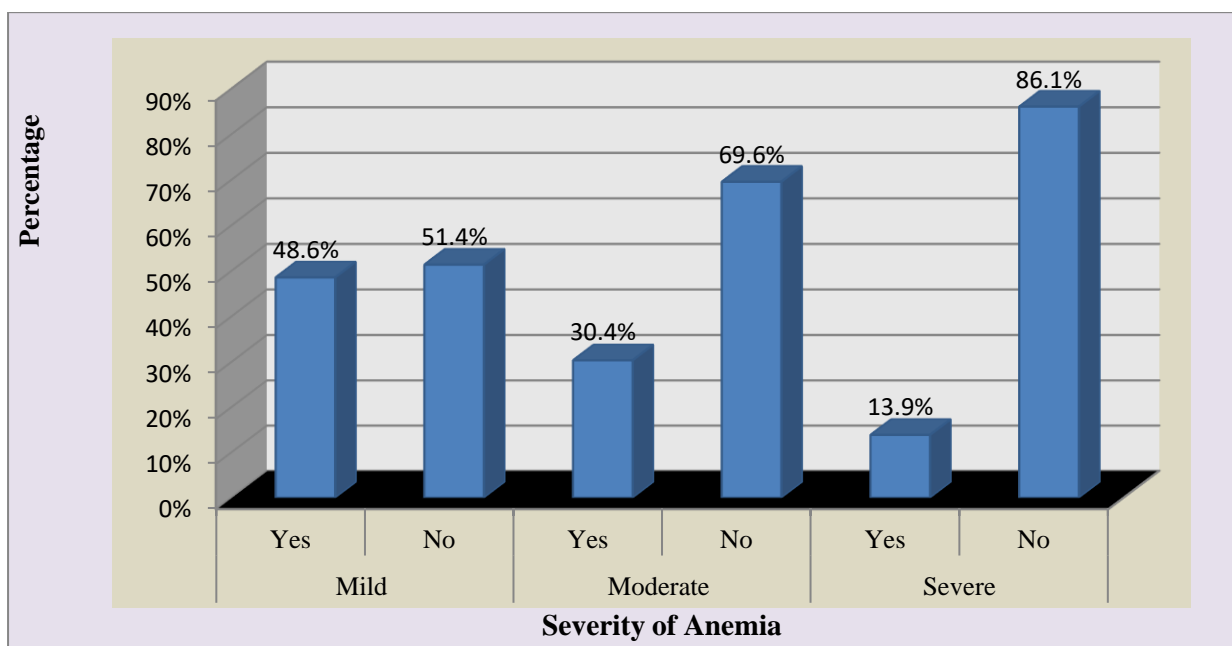

Figure 1: Severity of anemia in percentage

Prevalence, Morphological Classification, and Factors Associated With Severe Anemia among Children Under 5 Years of Age at Itojo Hospital

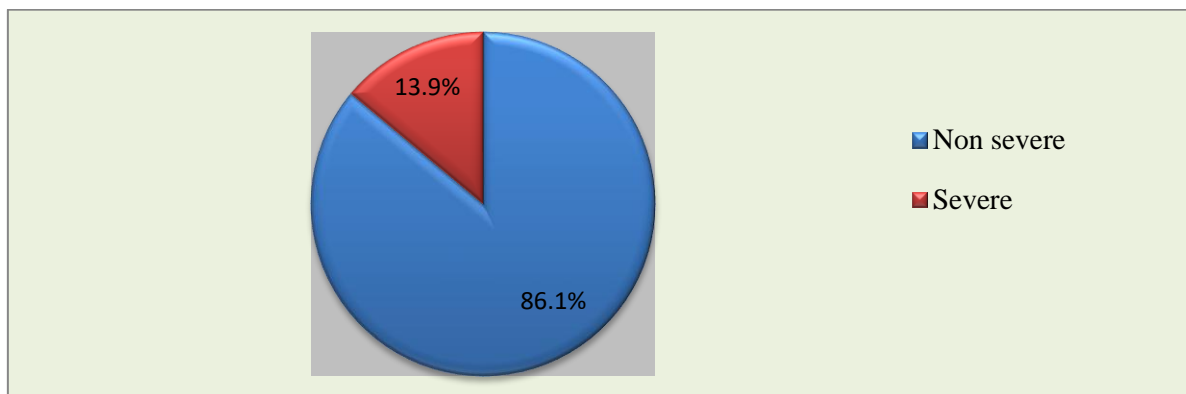
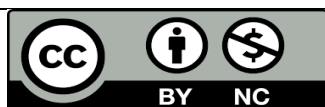

Figure 2: Prevalence of severe anemia among children under 5 years old



There is an Open Access article, distributed under the term of the Creative Commons Attribution – Non Commercial 4.0 International (CC BY-NC 4.0) (<https://creativecommons.org/licenses/by-nc/4.0/>), which permits remixing, adapting and building upon the work for non-commercial use, provided the original work is properly cited.

Entrepreneurial Skills of Student Entrepreneurs

Calvin J. Caliat

GESecOM department, College of Arts and Sciences, Mindanao State University Tawi-Tawi College of Technology and Oceanography, Bongao, Tawi-Tawi, 7500, Philippines



ABSTRACT: Entrepreneurial skills play an essential role in the entrepreneurial process to business success, especially for student entrepreneurs. This paper aims to identify the level of importance of entrepreneurial skills of student entrepreneurs at the Mindanao State University Tawi-Tawi College of Technology and Oceanography. A descriptive research method was used. The snowball and convenience sampling technique were applied for respondents' identification. There were 55 students who participated in this study from different course programs. A Likert-scaling survey questionnaire was employed for data collection. The percentage method was utilized to analyse the data collected. The result shows that all entrepreneurial skills are vitally important to the respondents. Creativity is the highest value as very important. However, communication and leadership skills are the highest response on not important. The significance is to help student entrepreneurs for business continuity through the technical assistance of the university by conducting seminars and training and financial support by public and private organizations.

KEYWORDS: Entrepreneurial Characteristics, Entrepreneurial Skills, Entrepreneurship, Student Entrepreneurs, Youth Entrepreneurship

I. INTRODUCTION

Entrepreneurship provides a solution to the problem of economy (Adejimola & Olufunmilayo, 2009), gender bias (Starchenko, 2020), fresh graduates' unemployment (Yohana, 2020), collective adjustment (Yusof et al., 2007), social unemployment (Setiawan, 2014; Chen et al., 2018; Li, 2021) especially in youth sector (Gwija et al, 2014; Farid & Rahman, 2020), and students' expenses (Caliat, 2024). For students, entrepreneurship creates a significant impact on their lives. It encourage-ages them to do business after college (Kurdyś-Kujawska & Wojtkowska, 2023; Caliat et al., 2024). According to Rembiasz (2017), students are motivated to engage in business and identify obstacles to their entrepreneurial engagement.

According to Yun & McNaughton (2021), at the University of Auckland, 8.4% of students were active young and small entrepreneurs, whereas almost 50% had no partners. About 45% of them are prepared to launch other businesses and manage their current business separately. 28.2% were focused on their existing business. With managing the new and existing businesses, the entrepreneurs shall understand how to administer and handle using their education, training and skills. Indeed, there is no formula required for a successful entrepreneur.

However, it is the skills that define success (Chapter 3 Entrepreneurs: Key Characteristics and Skills, n.d.). Various small-medium enterprises experienced failure due to the failure to identify their strengths and weaknesses (Lowden, 2007). Hence, knowledge is not only essential for a student entrepreneur (Schimperna et al., 2022) but also for various skills with an interdisciplinary approach to business (Haynie & Shepherd, 2009). Furthermore, the most valuable skills of successful entrepreneurs must be identified and measured (Sandoval, 2022). According to Romero and Gono (2021), entrepreneurial knowledge and skills are the primary obstacles that hinder students from pursuing business. Skills shall be identified and assessed by the entrepreneurs so they can understand mentally how to manage the financial, human and technical resources.

Thus, this study is rooted in the importance of entrepreneurial skills for success. It identifies the level of importance of various entrepreneurial skills. This study imparts information for student entrepreneurs who should understand the basic skills and their level of importance to success.

Entrepreneurial Skills of Student Entrepreneurs

A. Entrepreneurship

Entrepreneurship is a discipline that has various subfields according to its uses in society (Ratten, 2023). It is a complex system (Oganisjana & Koke, 2012) in the organization where new products are created from the inception of ideas to business engagement (Sousa & Almeida, 2014). Creating a product is not only done by an organization. However, it could also be made by individuals who engage (Stanford University, n.d.) to satisfy consumer demand (Kollie et al., 2011).

It is more than business startups; it includes the synergy of personal development skills and competencies (Cooney, 2012). An individual must undergo a process to create a business enterprise. Developing a business includes preparing pertinent business documents, assessing the characters and skills of entrepreneurs, and assessing the external environment. If students are able, they can enter or establish a new market.

B. Entrepreneurial Skills

It is fulfilling to pursue business career out-comes psychologically and economically (Ziemianski & Golik, 2020). An entrepreneur's career requires various skills to adapt to a changing business environment (Yener, 2020). However, entrepreneurial skills are part of psychological outcomes that are anchored to a universal concept according to the field of psychology. Chell (2013) defined skills as a complex concept that comprises cognitive, affective, behavioral, and context.

Entrepreneurial skills equate to business skills, which help an individual function in a changing business environment. They are a set needed to create innovative products that generate solutions in the community (Lyons, 2002). Creating innovative products requires attitudes and skills to begin (Vicens et al., 2022). Moreover, business skills are essential to business success (Irene, 2017). These skills are required to manage an enterprise successfully (Zahra et al., 2014), including decision making, risk taking, communication, creativity, ability to prepare business plan/research, negotiation, sales technique, financial knowledge, social networking, leadership, critical thinking and time management.

Decision-making is part of every aspect of human life, where individuals use their mental capacity to react to a situation (Colakkadioglu & Celik, 2016). It comprises three components: envision the objective, identify significant substitutes, and compare identified substitutes using assessment method (Siebert et al., 2022). According to Dodgson and Gann (2020), students should understand how to make decisions in solving problems. Through attending business training, student entrepreneurs acquire ideas for making decisions and the willingness to take risks (Kusmintarti et al., 2016) in addressing solutions to business problems (Littunen, 2000). The vital systematic decision of entrepreneurs lies in the future of the business. In an organization, the company head is responsible for making decisions using analysis and critical thinking (Ding, 2022; de Vries & Kroukamp, 2022).

Risk-taking is a prerequisite for achieving progress (Komulainen et al., 2009). It is an assurance of an individual's possible loss in a fortuitous event (Trimpop, 1994). Individuals make an assurance about dealing with uncertainties with a natural reaction to protect their identity (Zinn, 2016). In the business context, entrepreneurs must possess risk-taking skills in new ventures (Kerr et al., 2017; Fuentelsaz et al., 2018). According to Cater et al. (2022), risk-taking positively impacts entrepreneurs' entrepreneurial intentions. Aspiring business leaders were more motivated to take risks (Macko & Tyzka, 2009). Moreover, student entrepreneurs have a higher risk-taking inclination (Anwar & Saleem, 2019).

Communication involved exchanging ideas, beliefs, impressions, and even information (Sen, 2009). Entrepreneurs and business heads agreed on the importance of communication ability (Conrad & Newberry, 2011). In business, one of the components of entrepreneurial competencies is effective communication, which helps entrepreneurs explain, discuss, sell, and promote their products in the market (CEFE, n.d.). Effective communication helps entrepreneurs to convince investors (Dodgson & Gann, 2020) and strong will to entrepreneurial success (Makhbul, 2011). However, a lack of communication skills impacts entrepreneurs' failure (Bhaskar et al., 2022). Therefore, communication skills are essential for entrepreneurs.

Creativity is defined as a mental manner and principal competency that brings out and produces the discovery of new ideas through imagination (Dampérat et al., 2016; Tang et al., 2018). Creative ideas start from a dream, an insight, or mere observation (Habaradas & Tullao, 2017). In addition, the entrepreneurial process is linked with creative process activities to establish entrepreneurial applications (Kruger, 2005). Hence, it is essential for the entrepreneur (Birdthistle, 2008) and valid for new product and systems development using their talent and vision in business operation, also called creative entrepreneurship (Bujor & Avasilcai, 2016).

According to Cater et al. (2022), creativity is positively significant with entrepreneurial intentions and highly affects the EI in creating new and managing businesses (Koe et al., 2018 & Rakib et al., 2022). For student entrepreneurs, creativity impacts the team (Gundry et al., 2014) and improves current business methods (bin Mazla et al., 2020).

Acquiring skills is essential for business students in business education and employment (Calma, 2023). Skills such as preparing and developing a plan are primary skills for entrepreneurs to achieve specific goals in various business functions (CEFE, n.d.). A plan must be written, such as a business plan and research. To develop a good business plan, according to Bapanova et al. (2023),

Entrepreneurial Skills of Student Entrepreneurs

one of the various skills identified was research analysis and evaluation. Schrum and Bogdewiecz (2021) suggested that students must develop essential re-search skills. Enhancing this skill through competition helps participants produce startups and develop entrepreneurial skills (Russell et al., 2008).

Negotiation is defined as a manner of communication among individuals that has a common pursuit (Pienaar & Spoelstra, 1999), which has three views, including “process, the respective parties' objectives, and bargaining” (Ashcroft, 2004). It is also equated with persuasion or influence management (Lehmann & Winer, 2005). It is a crucial to success in the business working conditions (Fioravanti et al., 2022) and smooth transactions between suppliers and customers (Deac et al., 2014). The study by Petříková & Soroková (2016), one of the top responses of the student is the ability to persuade.

The study by Powers et al. (2014) discusses three conceptual dimensions of sales management skills – interpersonal, technical, and strategic skills. These three dimensions were essential to the success of sales management (Razmak et al., 2023). According to the study by Alvarez et al. (2015), there was an increasing demand for online sales training, so employers required more various sales skill sets and offered continuous training (Høgevoid et al., 2021).

Financial knowledge is a subset of financial literacy that should be used effectively for financial resources management of financial well-being (Hung et al., 2009). Guliman (2015) found out that most business owners have low levels of financial knowledge. The study by Dwi Radianto et al. (2019) found that young entrepreneurial financial literacy levels were moderate. Finally, it helps entrepreneurs decide on savings and financial management of their business (Cossa et al., 2018).

Networking is a process of strengthening the social relationships inside and outside an organization (Gibson et al., 2014), especially with customers and clients (CEFE, n.d.). According to Chen et al. (2010), student entrepreneurs have a high level of social networking skills, which helps to develop entrepreneurial intention (Zafar et al., 2012; Twum et al., 2021) and creates new business engagement (Lindelöf & Löfsten, 2004). A social-character person finds it easy to establish and maintain social relationships that might be in-vested the new business ideas by its network (Kusmintarti et al., 2016).

Leadership is the ability to create a vision for the firm and inspire the employees to achieve its goal collectively (CEFE, n.d.). It encompasses attitudes and behaviors influencing followers (Moore & Rudd, 2004). It is one of the essential skills to achieve business success and avail of business opportunities (Jasra et al., 2011). However, students develop leadership competencies through program-related roles such as organizing entrepreneurial leadership (Bagheri & Lope Pihie, 2012). Characteristics of a student entrepreneur leader are love challenges, adaptability (Bagheri et al., 2013), ability to decide quickly in difficult situations (Abu Mostafa et al., 2021), and vision-oriented (Omeihe et al., 2023).

Critical-thinking skills are defined as the systematic and rational method of providing an answer to a question. It is a systematic way of responding to the inquiry and explaining how a company can survive (Habaradas & Tullao, 2017). Tem et al. (2020) discovered that critical thinking is one of the most essential soft skills to expand entrepreneurs' competitiveness and productivity. Entrepreneurs must understand quantitative analysis, interpretation, and general number crunching (Lehmann & Winer, 2005). A study by Rodriguez and Lieber (2020) shows the positive significance of an entrepreneurial mind-set, especially in critical thinking and problem-solving. In addition, there is evidence that critical thinking has a positive correlation with creativity (Eggers et al., 2017) and a significant effect on entrepreneurship levels (Kırbaşlar & Özsoy-Güneş, 2015).

Time management aims to use time effectively while doing certain activities (Effeney et al., 2013) to accomplish goal-directed activities within a span of time (Little, 2018). It is an individuals' want to achieve greater independence (Davies et al., 2002) and a basic ability for life success (Gül et al., 2024). All aspects of life relate to time management, whether in individual or business organizations (Sayari et al., 2017). It is considered necessary for entrepreneurs to know how to handle pressures in busy lifestyles and take care of the business efficiently (CEFE, n.d.).

II. MATERIALS AND METHODS

The descriptive design is used to collect information from the primary participants. The critical respondents of this survey are the 55 student entrepreneurs from various colleges at the MSUTCTO. More information on the list of student entrepreneurs from any office on campus needs to be provided. Therefore, this study utilizes snowball and convenience sampling techniques. The assistance of the participants is essential to assist the research in identifying other potential respondents.

The survey method is employed to gather relevant information from the respondents through a structured questionnaire. The questionnaire is composed of two pages with three parts, including a personal profile, a business profile, and a rating on the important skills of an entrepreneur. There were questions that needed to be answered through a checklist. Moreover, the primary data were analysed using percentage analysis. The information is presented on tables.

Entrepreneurial Skills of Student Entrepreneurs

III. RESULTS & DISCUSSION

A. Personal and Business Profile of the Respondents

61% of the respondents were female, 36% were male, and 4% were members of the LGBTQ community. 23.36 years old was the average age of the key respondents. 34% of the respondents had mothers who were full-time housewives, and their fathers were government employees.

The business entity is managed depending on the form of ownership. Forms include sole proprietorship, partnerships, and corporations. 56% of the student entrepreneurs supervised the business by individual. Partnership (44%) administered the business. In this study, no corporation was formed by the students.

Moreover, entrepreneurs invest in services, merchandising, and manufacturing. 54% of the respondents were engaged in trading, while 41% were in manufacturing. Only 5% were ventured with services.

In merchandising, the student entrepreneurs in-vested in buying and selling goods, with 32% selling foods. Only 28% ventured into jewellery or clothing, and 16% into perfume. Those who manufactured were selling food. The 5% engaged in service work, including photography and transportation.

It is essential to identify the sources of capital in business. The student entrepreneurs sourced their investment from their allowance (54%), family (31%), and risk capital (11%). Moreover, the respondents (35%) gained estimated sales with a range of PhP 1,000.00—PhP999.00. 27% managed to collect PhP 16,000.00 and above.

B. Entrepreneurial Skills

Skills are prerequisites in managing a business, and the entrepreneur must understand the dynamics of using them to achieve the entrepreneurial firm's goals. The respondents rated these skills (Table 1) based on their importance: decision-making, risk-taking, communication, creativity, ability to prepare research or business plan, negotiation, sales technique, financial knowledge, networking, leadership, critical thinking, and time management.

The result shows that 61.82% of the respondents agreed that decision-making skills are vital. At the same time, 21.82% agreed to the essential. Decision-making is important for direction and strategic planning (Shepherd & Patzelt, 2017). Moreover, 72.73% of the respondents had varying positive degrees about the importance of risk-taking. This skill positively influences the decision for entrepreneurial intention (Vodă et al., 2019). Meanwhile, communication skills are vitally important to 60% of student entrepreneurs. 25.45% agreed that it is essential in business. Soft skills like communication are vital for entrepreneurs to labor market competence (Tem et al., 2020).

Table 1. Respondents' percentage on importance of skills of entrepreneurs

Skills	Very Important	Important	Neutral	Not Important	Very unimportant
Decision Making	61.82	21.82	14.55	0.00	0.00
Risk Taking	52.73	20.00	20.00	5.45	0.00
Communication	60.00	25.45	3.64	7.27	1.82
Creativity	63.64	20.00	10.91	3.64	0.00
Ability to Prepare Business Plan/Research	49.09	36.36	9.09	1.82	1.82
Negotiation	56.36	21.82	12.73	5.45	0.00
Sales Technique	54.55	29.09	10.91	3.64	0.00
Knowledge on finance	54.55	27.27	14.55	1.82	0.00
Networking	41.82	32.73	18.18	1.82	1.82
Leadership	54.55	18.18	14.55	7.27	1.82
Critical thinking or rational thinking	49.09	30.91	12.73	5.45	0.00
Time Management	61.82	25.45	5.45	5.45	0.00

IV. CONCLUSIONS

Based on the data discussed it answers the importance on the various skills in business ventures. According to Li et al. (2023), entrepreneurial skills are essential to entrepreneurial success. In the study, all skills are essential in business ventures to increase

Entrepreneurial Skills of Student Entrepreneurs

sales, expand their market horizon, and protect their market share. However, some skills have a value given by the respondent to be 50% below on a very important scale, including the ability to prepare a business plan/research, networking skills, and critical thinking. Moreover, among the enumerated entrepreneurial skills, the ability to prepare a business plan has almost the same value with very important and important scales.

It is crucial to manage a business without giving importance to various entrepreneurial skills (Bagheri & Lope Pihie, 2011). There are skills that are given a value of above 5% in not important, including risk-taking, communication, negotiation, leadership, critical thinking, and time management. But this 5% can never affect the importance level of the result. In conclusion, all skills have positive varying responses.

This study provides ideas for the campus to plan various activities to help the student entrepreneurs continue their business ventures and reach entrepreneurial goals. It informs concerned agencies to provide financial and technical support and expand their market. In addition, this study is essential for the participants to identify what skills they want to improve and develop.

REFERENCES

- 1) Abu Mostafa, Y.A., Salama, A.A., Abu Amuna, Y.M. and Aqel, A.M. 2021 The Role of Strategic Leadership in Activating Time Management Strategies to Enhance Administrative Creativity Skills "Case Study: Al-Azhar University." *International Journal of Academic Management Science Research*, Vol. 5 (3), pp 36-48. ISSN: 2643-900X
- 2) Adejmolola, A.S., and Olunfunmilayo, T-O. 2009 Spinning off an Entrepreneurship Culture among Nigerian University Students: Prospects and Challenges. *African Journal of Business Management*, Vol.3 (3), 080–088. ISSN 1993-8233
- 3) Alvarez, C. M. O., Taylor, K. A. and Rauseo, N. A. 2015 Creating Thoughtful Salespeople: Experiential Learning to Improve Critical Thinking Skills in Traditional and Online Sales Education. *Marketing Education Review*, 25(3), 233–243. <https://doi.org/10.1080/10528008.2015.1044859>
- 4) Anwar, I. and Saleem, I. 2019 Exploring Entrepreneurial Characteristics among University Students: An Evidence from India. *Asia Pacific Journal of Innovation and Entrepreneurship*, Vol. 13 No. 3, pp. 282–295. DOI 10.1108/APJIE-07-2018-0044
- 5) Ashcroft, S. 2004 Commercial Negotiation Skills. *Industrial and Commercial Training*, Vol. 36 No. 6, pp. 229–233. <https://doi.org/10.1108/00197850410556658>
- 6) Bagheri, A. and Lope Pihie, Z.A. 2011 On Becoming an Entrepreneurial Leader: A Focus on the Impacts of University Entrepreneurship Programs. *American Journal of Applied Sciences*, 8 (9): 884-892. ISSN 1546-9239
- 7) Bagheri, A. and Lope Pihie, Z. A. 2012 Role of University Entrepreneurship Programs in Developing Students' Entrepreneurial Leadership Competencies: Perspectives from Malaysian Undergraduate Students. *Journal of Education for Business*, 88(1), 51–61. <https://doi.org/10.1080/08832323.2011.638681>
- 8) Bagheri, A., Lope Pihie, Z. A. and Krauss, S. E. 2013 Entrepreneurial leadership competencies among Malaysian university student entrepreneurial leaders. *Asia Pacific Journal of Education*, 33(4), 493–508. <https://doi.org/10.1080/02188791.2013.822789>
- 9) Bapanova, G. K., Orekhova, N. V., Kadirizova, S. B., Kasbayeva, G. S. and Sholpankulova, G. K. 2023 Research Skills as the Student Learning Achievement. *International Journal of Educational Reform*, 0(0). <https://doi.org/10.1177/10567879231155874>
- 10) Bhaskar, P., K, G. and V, V. 2022 A Study on Challenges Faced by Entrepreneurs. *Journal of Positive School Psychology*, Vol. 6, No. 10, 3871-3879.
- 11) Bin Mazla, M.I., Bin Jabor, M.K., Tufail, K., Yakin, A.F.N. and Zainal, H. 2020 The Roles of Creativity and Innovation in Entrepreneurship. *Advances in Social Science, Education and Humanities Research*, <https://doi.org/10.2991/assehr.k.200921.035>
- 12) Birdthistle, N. 2008 An examination of tertiary students' desire to found an enterprise. *Education + Training*. 50(7), 552-567. DOI: 10.1108/00400910810909027
- 13) Bujor, A. and Avasilcai, S. 2016 The Creative Entrepreneur: A Framework of Analysis. *Procedia - Social and Behavioral Sciences*, 221, 21 – 28. doi: 10.1016/j.sbspro.2016.05.086
- 14) Caliat, C. (2024). Entrepreneurial Intention and Influence for Entrepreneurial Engagement of Student Entrepreneurs. (2024). *Social Science and Humanities Journal (SSHJ)*, 8(04), 34983-34999
- 15) Caliat, C.J., Dalhadi, N.J. and Ishmael, K.M. 2024 Entrepreneurship Education in the Lens of the Senior High School Students. *ASEAN Journal on Science and Technology for Development*, Vol. 41 (1), Art 2. DOI: <https://doi.org/10.61931/2224-9028.1554>
- 16) Calma, A. 2023 Using Assurance of Learning Data to Assess Business Students' Research Skills. *Quality Assurance in Education*, Vol. 31 No. 4, pp. 586-599. <https://doi.org/10.1108/QAE-01-2023-0003>

Entrepreneurial Skills of Student Entrepreneurs

- 17) Cater, J.J., Young, M., Al-Shammari, M. and James, K. 2022 Re-Exploring Entrepreneurial Intentions and Personality Attributes during a Pandemic. *Journal of International Education in Business*, Vol. 15 No. 2, pp. 311–330. <https://doi.org/10.1108/JIEB-04-2021-0050>
- 18) Chapter 3 Entrepreneurs: Key Characteristics and Skills. n.d. Center for Economic & Financial Education (CEFE). http://www.cefe.illinois.edu/tools/making%20a%20job/maj_student%20guide%20sample.pdf
- 19) Chell, E. 2013 Review of Skill and the Entrepreneurial Process. *International Journal of Entrepreneurial Behaviour and Research*, 19(1): 6-31. <https://doi.org/10.1108/13552551311299233>
- 20) Chen, S-C., Hsiao, H-C., Chang, J-C., Chou, C-M and Chen, D.-C. 2018 Strengthen Entrepreneurial Capacity in Entrepreneurial Competitions—International Conference on Cognition and Exploratory Learning in Digital Age. ISBN: 978-989-8533-81-4
- 21) Chen, W., Weng, C.S. and Hsu, H. 2010 A study of the Entrepreneurship of Taiwanese Youth by the Chinese Entrepreneur Aptitude Scale. *Journal of Technology Management in China*, 5(1) p.26-39. DOI: 10.1108/17468771011032778
- 22) Colakkadioglu, O. and Celik, B. 2016 The Effect of Decision-Making Skill Training Programs on Self-Esteem and Decision-Making Styles. *Eurasian Journal of Educational Research*, 65, 259-276. <http://dx.doi.org/10.14689/ejer.2016.65.15>
- 23) Conrad, D. and Newberry, R. 2011 24 Business Communication Skills: Attitudes of Human Resource Managers versus Business Educators. *American Communication Journal*, Vol 13 (1).
- 24) Cooney, T. 2012 Entrepreneurship Skills for Growth-Orientated Businesses. Danish Business Authority. Retrieved on May 2024 from https://www.oecd.org/cfe/leed/cooney_entrepreneurship_skills_HGF.pdf
- 25) Cossa, A., Madaleno, M. and Mota, J. 2018 Financial Literacy Importance for Entrepreneurship: A Literature Survey. *European Conference on Innovation and Entrepreneurship*, pp. 909-9016. <https://doi.org/https://tinyurl.com/ECIE18>
- 26) Dampérat, M, Jeannot, F., Jongmans, E. and Jolibert, A. 2016 Team Creativity: Creative Self-Efficacy, Creative Collective Efficacy and Their Determinants. *Recherche et Applications en Marketing*, 31(3): 6–25. <https://doi.org/10.1177/2051570716650164>
- 27) Davies, D.K., Stock, S.E. and Wehmeyer, M.L. 2002 Enhancing Independent Time-Management Skills of Individuals with Mental Retardation Using a Palmtop Personal Computer. *Ment Retard*, 40 (5): 358–365. [https://doi.org/10.1352/0047-6765\(2002\)040%3C0358:EITMSO%3E2.0.CO;2](https://doi.org/10.1352/0047-6765(2002)040%3C0358:EITMSO%3E2.0.CO;2)
- 28) de Vries, M. S., and Kroukamp, H. 2023 Decision-making skills in the fourth industrial revolution. *Teaching Public Administration*, 41(3), 389-407. <https://doi.org/10.1177/01447394221119087>
- 29) Deac, V., Vrîncuț M. and Păun, O. 2014 The Importance of Negotiation in Business Management. *Business Excellence and Management*, 4 (1), pp 37-46.
- 30) Ding, L. 2022 Improving the process of better decision-making skills in students in the society. *Global Journal of Medical, Physical and Health Education*, Vol 10 (1). DOI: 10.15651/2449-1802.22.10.042
- 31) Dodgson, M. and Gann, D. 2020 Universities Should Support More Student Entrepreneurs. Here's Why—And How. Available online: <https://www.weforum.org/agenda/2020/10/universities-should-support-more-student-entrepreneurs/> (accessed on June 02 2024).
- 32) Dwi Radianto, W.E., Efrata, T.C. and Dewi, L. 2019 Level of Financial Literacy in Young Entrepreneurs: Study on Entrepreneurship-based University. *International Conference on Economics, Education, Business and Accounting, KnE Social Sciences*, pages 385–398. DOI 10.18502/kss.v3i11.4022
- 33) Effeney, G., Carroll, A. and Bahr, N. 2013 Self-Regulated Learning: Key strategies and their sources in a sample of adolescent males. *Australian Journal of Educational & Developmental Psychology*. Vol 13, pp. 58-74. ISSN 1446-5442
- 34) Eggers, F., Lovelace, K.J. and Kraft, F. 2017 Fostering creativity through critical thinking: The case of business startup simulations. *Creativity and Innovation Management*, Vol 26 (3), p. 266-276. <https://doi.org/10.1111/caim.12225>
- 35) Farid, S. M. and Rahman, S. A. 2020 Identifying the Challenges of Involvement in Entrepreneurship Activities among a Group of Undergraduates. *International Journal of Contemporary Educational Research*, 7(2), 246-257. DOI: <https://doi.org/10.33200/ijcer.697597>
- 36) Fioravanti, M.L., de Oliveira Sestito, C. D., de Deus, W. S., Scatalon, L. P. and Barbosa, E. F. 2022 Role-Playing Games for Fostering Communication and Negotiation Skills. *IEEE Transactions on Education*, Vol. 65 (3), pp. 384-393. doi: 10.1109/TE.2021.3117898.
- 37) Gibson, C., H. Hardy III, J. and Ronald Buckley, M. 2014 Understanding the Role of Networking in Organizations. *Career Development International*, Vol. 19 No. 2, pp. 146-161. <https://doi.org/10.1108/CDI-09-2013-0111>
- 38) Gül, M., Golmohammadi, H., Pashaie, S. and Tuncer, M. 2024 Analyzing the Relationship Between Individual Time Management Skills and Business Attitude of Sports Science Students. *Physical Culture and Sport. Studies and Research*, 2024, 102, 58–69. DOI: 10.2478/pcssr-2024-0005

Entrepreneurial Skills of Student Entrepreneurs

- 39) Guliman, S.D.O. 2015 An Evaluation of Financial Literacy of Micro and Small Enterprise Owners in Iligan City: Knowledge and Skills. *Journal of Global Business*, Vol 4 (1),
- 40) Gundry, L.K., Ofstein, L.F. and Kickul, J.R. 2014 Seeing around corners: How creativity skills in entrepreneurship education influence innovation in business. *The International Journal of Management Education*, Vol 12 (3), pp 529-538. <https://doi.org/10.1016/j.ijme.2014.03.002>
- 41) Gwija, S.A., Eresia-Eke, C. and Iwu, C.G. 2014 Challenges and Prospects of Youth Entrepreneurship Development in a Designated Community in the Western Cape, South Africa. *Journal of Economics and Behavioral Studies*, Vol. 6, No. 1, pp. 10-20. ISSN: 2220-6140.
- 42) Habaradas, R. B. and Tullao, T. S. 2017 *Pathways to Entrepreneurship*. Quezon City: Phoenix Publishing House, Inc.
- 43) Haynie, M. and Shepherd, D.A. 2009 A Measure of Adaptive Cognition for Entrepreneurship Research. *Entrepreneurship Theory and Practice*, 33: 695–714. <https://doi.org/10.1111/j.1540-6520.2009.00322.x>
- 44) Hidayatulloh, M.K.Y. and Ashoumi, H. 2022 Creativity and entrepreneur knowledge to increase entrepreneurial intent among vocational school students. *Journal of Education and Learning*, Vol. 16, No. 4, pp. 434~439. DOI: 10.11591/edulearn.v16i4.19771
- 45) Høgevold, N., Rodriguez, R., Svensson, G. and Otero-Neira, C. 2021 B to B Sellers' Skill Level in Sales Performance – Frameworks and Findings. *Journal of Business-to-Business Marketing*, 28(3), 265–281. <https://doi.org/10.1080/1051712X.2021.1974169>
- 46) Hung, A.A., Parker, A.M. and Yoong, J.K. 2009 Defining and Measuring Financial Literacy. RAND Working Paper Series WR-708, Available at SSRN: <https://ssrn.com/abstract=1498674> or <http://dx.doi.org/10.2139/ssrn.1498674>
- 47) Irene, B. 2017 Women entrepreneurship in South Africa: understanding the role of competencies in business success. *The Southern Africa Journal of Entrepreneurship and Small Business Management*, Vol 9 (1). DOI:10.4102/sajesbm.v9i1.121
- 48) Jasra, J.M., Khan, M.A., Hunjra, A.I., Rehman, R.A.U. and Azam, R. 2011 Determinants of Business Success of Small and Medium Enterprises. *International Journal of Business and Social Science*, Vol. 2 No. 20. <https://ssrn.com/abstract=2130356>
- 49) Kerr, S.P., Kerr, W.R. and Xu, T. 2017 Personality Traits of Entrepreneurs: A Review of Recent Literature. (Working Paper 18-04). https://www.hbs.edu/ris/Publication%20Files/18-047_b0074a64-5428-479b-8c83-16f2a0e97eb6.pdf
- 50) Kharbanda, O.P. and Stallworthy, E.A. 1991 Negotiation: An Essential Management Skill. *Journal of Managerial Psychology*, Vol. 6 No. 4, pp. 2-52. <https://doi.org/10.1108/EUM000000001732>
- 51) Kirbaşlar, M. and Özsoy-Güneş, Z. 2015 The effect of critical thinking disposition on entrepreneurship levels: A Study on Future Teachers. *Procedia - Social and Behavioral Sciences*, 174, 199 – 207. doi: 10.1016/j.sbspro.2015.01.647
- 52) Koe, W.L., Krishnam, R. and Utami, S. 2018 The Influence of Entrepreneurial Skills On Business Startup Intention Among Bumiputra Students. *Journal of Advanced Manufacturing Technology*, Vol. 12 (2). ISSN: 1985-3157
- 53) Kollie, J., Louw, W., Monyolo, R., Nkambule, V., Lashley, M., Oriakhi, R., Peters-Richardson, J., Tinai, S., Mphanya, T., Daniel, C. and Powley, R. 2011 Introduction to Entrepreneurship [Course Guide]. Commonwealth of Learning. <https://oasis.col.org/server/api/core/bitstreams/24fc6ce7-028e-48b7-8b48-15670a5a5223/content>
- 54) Komulainen, K., Korhonen, M. and Rätty, H. 2009 Risk-taking abilities for everyone? Finnish entrepreneurship education and the enterprising selves imagined by pupils. *Gender and Education*, 21(6), 631–649. <https://doi.org/10.1080/09540250802680032>
- 55) Kruger, M.E. 2005 Creativity in the Entrepreneurship Domain. [Doctoral Dissertation: University of Pretoria]. UPspace Institutional Repository. <http://hdl.handle.net/2263/27491>
- 56) Kurdyś-Kujawska, A. and Wojtkowska, A. 2023 To Be or Not to Be... An Entrepreneur: What Motivates and What Limits Students' Entrepreneurial Initiatives? *Scientific Papers of Silesian University of Technology Organization and Management*, Series No. 188. <http://dx.doi.org/10.29119/1641-3466.2023.188.15>
- 57) Kusmintarti, A., Thoyib, A., Maskie, G. and Ashar, K. 2016 Entrepreneurial Characteristics as a Mediation of Entrepreneurial Education Influence on Entrepreneurial Intention. *Journal of Entrepreneurship Education*, Vol 19 (1).
- 58) Lehmann, D.R. and Winer, R.S. 2005 *Product Management*, Fourth Edition. McGraw Hill Irwin: New York
- 59) Li, G., Long, Z., Jiang, Y., Huang, Y., Wang, P. and Huang, Z. 2023 Entrepreneurship education, entrepreneurship policy and entrepreneurial competence: mediating effect of entrepreneurship competition in China. *Education + Training*, Vol. 65 No. 4, pp. 607-629. <https://doi.org/10.1108/ET-06-2021-0218>
- 60) Li, Y. 2021 Research on the Growth Path of College Student Entrepreneurs—A Case Study of Chengdu City in China. *Advances in Social Science, Education and Humanities Research*, Vol 543. <https://doi.org/10.2991/assehr.k.210407.153>

Entrepreneurial Skills of Student Entrepreneurs

- 61) Lindelöf, P. and Löfsten, H. 2004 Proximity as a Resource Base for Competitive Advantage: University-Industry Links for Technology Transfer. *Journal of Technology Transfer*, 29(3-4), 311-326.
<https://doi.org/10.1023/B:JOTT.0000034125.29979.ae>
- 62) Little, B. 2018 Time Management. In: Zeigler-Hill, V., Shackelford, T. (eds) *Encyclopedia of Personality and Individual Differences*. Springer, Cham. https://doi.org/10.1007/978-3-319-28099-8_871-1
- 63) Littunen, H. 2000 Entrepreneurship and the Characteristics of the Entrepreneurial Personality. *International Journal of Entrepreneurial Behavior & Research*, Vol. 6 No. 6, pp. 295-310. <https://doi.org/10.1108/13552550010362741>
- 64) Lowden, J.S. 2007 *Managerial Skills for the Entrepreneur*. Emerald Blackfiles.
- 65) Lyons, T.S. 2002 Building Social Capital for Rural Enterprise Development: Three Case Studies in the United States. *Journal of Developmental Entrepreneurship*, Vol. 7, no. 2: 193-216
- 66) Macko, A. and Tyzska, T. 2009 Entrepreneurship and Risk Taking. *Applied Psychology*, Vol 58 (3).
<https://doi.org/10.1111/j.1464-0597.2009.00402.x>
- 67) Makhbul, Z.M. 2011 Entrepreneurial Success: An Exploratory Study among Entrepreneurs. *International Journal of Business and Management*, Vol. 6, No. 1; E-ISSN 1833-8119
- 68) Moore, L.L. and Rudd, R.D. 2004 Leadership Skills and Competencies for Extension Directors and Administrators. *Journal of Agricultural Education*, Vol 45 (3), pp. 22-33. DOI: 10.5032/jae.2004.03022
- 69) Oganisjana, K. and Tatjana K. 2012 Does Competence-Oriented Higher Education Lead to Students' Competitiveness? *Engineering Economics*, 23: 77–82. doi.org/10.5755/j01.ee.23.1.1228
- 70) Omeihe, I., Harrison, C., Simba, A. and Omeihe, K. 2023 The role of the entrepreneurial leader: a study of Nigerian SMEs. *International Journal of Entrepreneurship and Small Business*, Vol. 49, No. 2.
- 71) Petříková, D. and Soroková, T. 2016 Managerial and Entrepreneurial Skills as Determinants of Business. *Polish Journal of Management Studies*, Vol.14, No.1. DOI: 10.17512/pjms.2016.14.1.17
- 72) Pienaar, W.D. and Spoelstra, H.I.J. 1999 *Negotiation: Theories, Strategies and Skills*. Juta & Co, LTD.
- 73) Powers, T. L., Jennings, J. C. and DeCarlo, T. E. 2014 An assessment of needed sales management skills. *Journal of Personal Selling & Sales Management*, 34(3), 206–222. <https://doi.org/10.1080/08853134.2014.890900>
- 74) Rakib, M., Azis, M., Azis, F. and Sanusi, D.A. 2023 The Effect of Self-Leadership and Self-Efficacy on Entrepreneurship Creativity: An Empirical Study on Online Business Students. *Pegem Journal of Education and Instruction*, Vol. 13, No. 3, 209-214. DOI: 10.47750/pegegog.13.03.22
- 75) Rakib, M., Tawe, A., Azis, M., Syam, A., and Sanusi, D.A. 2022 Determinants of Entrepreneurial Intention: Empirical Study of Student Entrepreneurs. *Academic of Entrepreneurship Journal*, 26(3): 1–12.
- 76) Ratten, V. 2023 Entrepreneurship: Definitions, Opportunities, Challenges, and Future Directions. *Global Business and Organizational Excellence*, 42:79–90. DOI: 10.1002/joe.22217
- 77) Razmak, J., Pitzel, J.W., Belanger, C. and Farhan, W. 2023 Brushing up on Time-Honored Sales Skills to Excel in Tomorrow's Environment. *Journal of Business & Industrial Marketing*, Vol. 38 No. 4, pp. 701-723.
<https://doi.org/10.1108/JBIM-12-2020-0533>
- 78) Rembiasz, M. 2017 Student Entrepreneurship – Research on Development. *MATEC Web of Conferences*, 121, 12015.
DOI: 10.1051/mateconf/20171211201
- 79) Rodriguez, S. and Lieber, H. 2020 Relationship Between Entrepreneurship Education, Entrepreneurial Mindset, and Career Readiness in Secondary Students. *Journal of Experiential Education*, 43(3), 277-298.
<https://doi.org/10.1177/1053825920919462>
- 80) Romero, R.S. and Gono, E.R. 2021 Obstacles in Pursuing Business among Entrepreneurship Students. *The International Journal of Business Management and Technology*, Vol 5 (5). ISSN: 2581-3889
- 81) Russell, R., Atchison, M. and Brooks, R. 2008 Business Plan Competitions in Tertiary Institutions: Encouraging Entrepreneurship Education. *Journal of Higher Education Policy and Management*, Vol 30 (2), p123-138.
DOI: 10.1080/13600800801938739
- 82) Sandoval, L.A. 2022 The Knowledge and Skills Required to Be a Successful Entrepreneur. *Applied Economics Teaching Resources*, Vol 4 (1)
- 83) Sayari, K., Jalagat, R. and Dalluay, V. 2017 Assessing the Relationship of Time Management and Academic Performance of the Business Students in Al-Zahra College for Women. *European Business & Management*, 2017; 3(1): 1-8.
doi: 10.11648/j.ebm.20170301.11
- 84) Schimperna, F., Nappo, F. and Marsigalia, B. 2022 Student Entrepreneurship in Universities: The State-of-the-Art. *Administrative Sciences*, 12: 5. <https://doi.org/10.3390/admsci12010005>

Entrepreneurial Skills of Student Entrepreneurs

- 85) Schrum, K., and Bogdewiecz, S. 2021 Cultivating research skills through scholarly digital storytelling. *Higher Education Research & Development*, 41(7), 2382–2394. <https://doi.org/10.1080/07294360.2021.2010667>
- 86) Sen, L. 2009 *Communication Skills: Second Edition*. PHI Learning Private Limited: New Delhi
- 87) Setiawan, J.L. 2014 Examining Entrepreneurial Self-Efficacy among Students. *Procedia – Social and Behavioral Sciences*, 115, pp 235-242. doi: 10.1016/j.sbspro.2014.02.431
- 88) Shepherd, D.A. and Patzelt, H. 2017 Researching Entrepreneurial Decision Making. In: *Trailblazing in Entrepreneurship*. Palgrave Macmillan, Cham. https://doi.org/10.1007/978-3-319-48701-4_8
- 89) Siebert, J.U., Becker, M. and Oeser, N. 2022 Making a good career choice: A decision-analytical intervention to enhance proactive decision-making and career choice self-efficacy in high school students. *Decision Sciences Journal of Innovative Education*, Volume 21, Issue 1 p. 10-25. <https://doi.org/10.1111/dsji.12280>
- 90) Sousa, J.M. and Almeida, M.D.R. 2014 Entrepreneurial skills development. *Recent Advances Economics*, 135-139. ISBN: 978-960-474-394-0
- 91) Stanford University. n.d. What is Entrepreneurship? Stanford Online. <https://online.stanford.edu/what-is-entrepreneurship>
- 92) Starchenko, L. 2020 Impact of Gender Aspects of Sustainable Entrepreneurship on Country Innovative Development. *Marketing and Management of Innovations*, 4, 304-311. <http://doi.org/10.21272/mmi.2020.4-25>
- 93) Tang, C., Byrge, C. and Zhou, J. 2018 Creativity Perspective on Entrepreneurship. In: Turcan, R., Fraser, N. (eds) *The Palgrave Handbook of Multidisciplinary Perspectives on Entrepreneurship*. Palgrave Macmillan, Cham. https://doi.org/10.1007/978-3-319-91611-8_5
- 94) Tem, S., Kuroda, A. and Ngang Tang, K. 2020 The Importance of Soft Skills Development to Enhance Entrepreneurial Capacity. *International Educational Research*; Vol. 3, No. 3. <https://doi.org/10.30560/ier.v3n3p1>
- 95) Trimpop, R.M. (Ed.). 1994 Chapter 1: What Is Risk Taking Behavior?. *Advances in Psychology*. Vol 107, pp 1-14. [https://doi.org/10.1016/S0166-4115\(08\)61295-9](https://doi.org/10.1016/S0166-4115(08)61295-9)
- 96) Twum, K.K., Kwakwa, P.A., Ofori, D. and Nkukpornu A. 2021 The Relationship Between Individual Entrepreneurial Orientation, Network Ties, and Entrepreneurial Intention of Undergraduate Students: Implications on Entrepreneurial Education. *Entrepreneurship Education*, Vol 4, 39–66. <https://doi.org/10.1007/s41959-021-00044-w>
- 97) Utama, A.N.B. and Syarif, A. 2023 Student Perspectives on Financial Literacy to Support Entrepreneurial Character. *Journal of Business Studies and Management Review*, Vol.6, No.2. E-ISSN: 2597-6265
- 98) Vicens, G.R., Casanovas, L.V., Canals, C.S. and Serra, L. 2022 Entrepreneurship Analysis in Spanish Universities. *Higher Education, Skills and Work-Based Learning*, Vol. 12 No. 1, pp. 178-190. DOI 10.1108/HESWBL-11-2020-024
- 99) Vodă, A.I., Covatariu, D. and Ghiuță, O-A. 2019 Student's Entrepreneurial Intentions: Role of Entrepreneurial Education and Risk Taken Ability. *Environmental Engineering and Management Journal*, Vol. 18, No. 7, 1527-1534
- 100) Wait, M. and Stiehler, B. 2021 Student Self-Determination and Boundaries: An Emerging Market Perspective on the Development of Sales Skills. *South African Journal of Higher Education*, Vol. 35, No. 6. https://hdl.handle.net/10520/ejc-high_v35_n6_a14
- 101) Yener, H. 2020 Effects of Decision-Making Styles on Entrepreneurship Skills. *Technium Social Sciences Journal*, Vol 8, pp 569-578. ISSN: 2668-7798
- 102) Yohana, C. 2020 Factors Influencing the Development of Entrepreneurship Competency in Vocational High School Students: A Case Study. *International Journal of Education and Practice*, Vol. 8, No. 4, pp. 804-819. DOI: 10.18488/journal.61.2020.84.804.819
- 103) Yun, A. and McNaughton, R.B. 2021 Student Entrepreneurship at the University of Auckland 2021. *Global University Entrepreneurial Spirit Students' Survey 2021 - National Report New Zealand*. Auckland: University of Auckland.
- 104) Yusof, M., Sandhu, M.S. and Jain, K.K. 2007 Relationship Between Psychological Characteristics and Entrepreneurial Inclination: A Case Study of Students at University Tun Abdul Razak (UNITAR). *Journal of Asia Entrepreneurship and Sustainability*, Vol III (2)
- 105) Zafar, M.J., Yasin, G., and Ijaz, M. 2012 Social networking a source developing entrepreneurial intentions among entrepreneurs: A case of Multan. *Asian Economic and Financial Review*, 2(8), 1072-1084.
- 106) Zahra, A., Fakhrisadat, N. and Narges, I. 2014 Explaining the Role of Managerial Skills of Entrepreneurship in Business Success. *International Journal of Management Sciences*, Vol. 4, No. 1, 42-52.
- 107) Ziemianski, P. and Golik, J. 2020 Including the Dark Side of Entrepreneurship in the Entrepreneurship Education. *Education Sciences*, 10, 211; doi:10.3390/educsci10080211
- 108) Zinn, J. O. 2017 The meaning of risk-taking – key concepts and dimensions. *Journal of Risk Research*, 22(1), 1–15. <https://doi.org/10.1080/13669877.2017.1351465>

Analyze the Physical Performance of Elite Athletes: Relationship between Leg Muscle Explosive Power, Flexibility, and Balance in Elite Taekwondo Athletes Pre-Porprov West Java



Ria Apriliani¹, Muhammad Furqon Hidayatullah², Haris Nugroho³, Slamet Riyadi⁴, Singgih Hendar⁵

^{1,2,3,4,5}Sebelas Maret University, Indonesia

ABSTRACT: This study carried out on elite athletes from West Java Province to analyze the physical performance of elite athletes, namely power, flexibility and balance on the accuracy of their dollyo chagi kicks on these three physical performances. In two previous studies, it was known that physical performance had an influence on the psychology and physiology of athletes, both elite and non-elite athletes. Therefore, this research aims to provide reference material for non-elite taekwondo athletes to determine the physical performance profile of elite athletes so they can excel and achieve targets in national and international competitions, especially for athletes with the peak age of performance according to their LTAD age, namely 18-24 years. A sample of 75 people was taken using the total sampling method from 6 cities and districts in West Java. The development method is the method used in this research by finding the mean and standard deviation with of each test variable. From this research, it is known that the standard deviation of power is 30.730; flexibility, namely 7.793; balance 2,335; and dollyo chagi of 19,007 with an average power of 2.10 meters, flexibility of 20.88 cm, and balance of 3.67 seconds.

KEYWORDS: Power, Flexibility, Balance, Taekwondo, Elite Athlete

INTRODUCTION

In a condition of prime fitness, a person needs to do physical exercise which involves physical condition with the correct exercise method (Bompa, Tudor O.; Buzzichelli, 2019). The components of physical condition are: strength, endurance, explosive power, speed, flexibility, agility, coordination, balance, accuracy, and reaction (Widiastuti, 2015). Physical performance that is different from other sports probably comes from the wide age range of performance of Olympic athletes (Longo et al., 2016).

Taekwondo is the most popular Korean martial art and is also the national sport of Korea (Falaahudin et al., 2020). Taekwondo is a martial art that requires speed and strength (Gatsis et al., 2021). Taekwondo is oriented towards kicking and punching movements and upholds discipline, ethics and good behavior (Mailapalli et al., 2015). Taekwondo has many advantages, not only teaching physical aspects, such as fighting skills, but also emphasizing teaching mental discipline aspects (Song & Yang, 2019). Thus, Taekwondo will form a strong mental attitude and good ethics for those who seriously study it. Taekwondo contains deep philosophical aspects so that in studying Taekwondo, the mind, soul, and body as a whole will be grown and developed (Yang et al., 2020).

Taekwondo means a martial art that uses techniques to produce a form of beautiful movement (Apriantono et al., 2020). Three important materials in practicing Taekwondo are the moves in the martial art itself (Taegeuk), the technique of breaking hard objects (Kyukpa), and the last is fighting in Taekwondo martial arts (Kyorugi) (Kim & Nam, 2021). Learning Taekwondo cannot only touch on the technical skills aspect of self-defense, but also includes the physical, mental and spiritual aspects so that there is a balance between them (Lafanda et al., 2015).

At the 2012 London Olympics, the men's lowest weight category, namely under 58kg between Joel Gonzales Bonilla (ESP) and Lee Dae Hoon (KOR), was won by Joel Gonzales Bonilla with a score of 17-8. The 17 points in detail resulted from 7 momtong

Analyze the Physical Performance of Elite Athletes: Relationship between Leg Muscle Explosive Power, Flexibility, and Balance in Elite Taekwondo Athletes Pre-Porprov West Java

dollyo chagi kicks, 2 elgol dollyo chagi kicks, 1 punch, and 3 points from kyonggo (mistakes made by Lee Dae Hoon. Meanwhile, Lee Dae Hoon got 8 points from 7 momtong kicks dollyo chagi and 1 kyonggo. All the kicks or 2 elgol dollyo chagi kicks that Bonilla executed were kicks that were on target and were effective in producing 6 points, but 22 of the 41 dollyo chagi momtong kicks or only 32% of the kicks were on target. Another case with the heaviest class in the men's category at the 2016 Rio Olympics, namely over 80 kg. The match between Abdoulrazak Issoufou Alfaga (NIG) and Radik Isaev (KAZ) was actually won by the Kazakstan athlete with a final score of 2-6. Alfaga was able to perform 18 momtong kicks dollyo chagi and 18 elgol dollyo chagi kicks but none of them were effective in producing points. Meanwhile, Isaev did 10 momtong dollyo chagi kicks although none of them were on target and 1 of 2 elgol dollyo chagi kicks managed to score points.

The results of these two analyzes show that body weight class will influence the intensity of kicks performed by taekwondo athletes. Likewise with the effectiveness of these kicks in generating points in each weight class. The number of kicks performed also experienced a significant difference between the men's and women's lowest weight classes at the 2020 Tokyo Olympics, female athletes performed more kicks than men but their effectiveness was low. This can be caused by the amount of flexibility, explosive power and balance of the kick which are influential. Differences in gender, competition class and age will be factors that cause differences in the effectiveness value of the dollyo chagi kick which is caused by the intensity and accuracy of the kick (Mailapalli et al., 2015)

In previous research conducted research entitled Physical, physiological and psychological profiles of elite Turkish taekwondo athletes in 2020. They conducted research on explosive power, agility, flexibility, reaction speed and balance using the vertical jump method for explosive power, sit and reach for flexibility, and running on a treadmill for a balance test. The findings of this research reveal the physical, physiological and psychological characteristics of taekwondo (Lafanda et al., 2015). Test results can be useful for assessing the performance of taekwondo players. In the research Identification of elite performance characteristics in a small sample of taekwondo athlete (Tirtawirya et al., 2019). Anthropological tests and 6 physical performance tests for elite and non-elite athletes as well as three coordination tests for adolescent athletes. This research confirms that knowledge about the physical performance of elite athletes will develop along with their coordination (Di Domenico et al., 2019).

Research on physical performance conditions and comparisons between elite and non-elite athletes in two previous studies has developed knowledge about physical performance and elite athletes but still has not confirmed the existence of physical performance in elite athletes and the ease of research tools used in each study. This research was conducted on elite athletes from West Java Province regarding the accuracy of their dollyo chagi kicks in this study. Therefore, this research aims to be a reference material for non-elite taekwondo athletes to determine the physical performance profile of elite athletes so they can excel and achieve targets in national and international competitions, especially for athletes at their peak age of performance according to their LTAD age (Chaabene et al., 2018).

METHODS

The research method used in this research is a development method that takes samples from the entire population the entire population of elite athletes or a total sampling of 75 people sourced from 6 cities and districts in West Java, namely Depok City, Bogor City, Bandung City, Bekasi City, West Bandung Regency, and Bogor Regency.

Standing Board Jump is a form of fitness test method that is commonly used to determine the power of a person's leg or foot muscles or the explosive power of a person's leg muscles. The higher or further the jump, the stronger the leg muscle power or explosive power of an athlete. The purpose of this test is to determine and measure explosive power or leg muscle power. The assessment is taken from the furthest number of the 3 jump attempts achieved by the sample.

The flexibility test in the leg muscles is using the V-sit and reach test instrument. This instrument was used because it was considered more efficient for a sample of taekwondo athletes who needed flexibility, especially in the hamstring muscles to create high kicks.

Balance test participants will be tested with the Balance Board Test instrument. This instrument is used because the sport of taekwondo is dominated by dynamic balance movements. The assessment is taken from the number of 3 test attempts achieved by the sample. With the three instruments above, the total number of dollyo chagi kicks, both momtong dollyo chagi and elgol dollyo chagi kicks, will be compared for each 1 minute. The test was analyzed using SPSS 24.0 software, descriptive analysis involves calculating the mean and standard deviation.

RESULTS AND DISCUSSION

The results of multiple linear regression testing on explosive power, flexibility and balance on the dollyo chagi kick in elite

Analyze the Physical Performance of Elite Athletes: Relationship between Leg Muscle Explosive Power, Flexibility, and Balance in Elite Taekwondo Athletes Pre-Porprov West Java

athletes produced a constant value of 79.669 and a regression coefficient value of. Then the regression equation becomes $Y = 79.669 + 0.209X_1 + 0.623X_2 - 0.075 X_3$. The results of the linearity significance test analysis with the regression equation are:

Table 1. Significance and linearity test results of regression of Y with X1, X2, and X3

Model		Sum of Squares	Df	Mean Square	F	Sig
1	Regression	4799,146	3	1599,715	5,178	0,003
	Residual	21935,520	71	308,951		
	Total	26734,667	74			

Significant Value $0.003 < 0.05$; it is said to have had a significant influence on Dollyo Chagi's kick. The calculated F value in the regression above is 5.178

$Df_1 = 3 - 1 = 2$; $df_2 = 75 - 3 = 72$; F_{table} with a Df value of 72 is 2.73.

Table 2. Coefficient Correlation

Responden (n)	(r_{y123})	Rsquare	Fcount	Ftable
75	0,424	0,180	5,178	2,73

Fcount value $> F_{table}$; $5.178 > 2.73$; then it is said to have a significant influence on Dollyo Chagi's kick at $\alpha = 0.05$. Based on these data, the first hypothesis "There is a relationship between explosive power, flexibility and balance on the dollyo chagi kick in elite taekwondo athletes" was accepted, and H_0 was rejected. Likewise, the value of the coefficient of determination (Rsquare) in the contribution of variable So 82% of them will be caused by other factors.

Table 3. Results of the relationship and significance tests of Y with X1, X2, and X3

	B	Significance
(Constant)	79,669	0,000
power	0,209	0,002
flexibility	0,623	0,021
balance	-0,075	0,934

$$y = 79.669 + 0.209X_1 + 0.623X_2 - 0.075 X_3$$

The following is an interpretation of the relationship between variables from the multiple linear regression equation in the table above: Constant = 79.669, that is, if explosive power (kg.m/second), flexibility (cm), and balance are zero (0), then the dollyo chagi kicking ability (seconds) is 79.669

- The X_1 coefficient of 0.209 states that if the explosive power increases by 1 point, the dollyo chagi kicking ability will increase by 0.209, and vice versa, assuming the other independent variables remain constant.
- The X_2 coefficient of 0.623 states that if flexibility increases by 1 point, the dollyo chagi kicking ability will increase by 0.623, and vice versa, assuming the other independent variables remain constant.
- The X_3 coefficient of -0.075 states that if the balance increases by 1 point, Dollyo Chagi's kicking ability will decrease by 0.075, and vice versa, assuming the other independent variables remain constant.

CONCLUSION

The results of the correlation analysis between variables X_1 , X_2 and X_3 and Y have a correlation coefficient of -0.424 with N of 75 people. Therefore, it can be concluded that the close relationship between flexibility and balance and the dollyo chagi kick is moderate, but if the value of flexibility and balance increases, the value of the dollyo chagi kick increases.

Based on the calculation results in the f test, the results show a significant value of $0.003 < 0.05$; it is said to have had a significant influence on Dollyo Chagi's kick. The calculated f value is $5.178 > 2.73$, namely f table; it is said to have had a significant influence on Dollyo Chagi's kick. This is also shown by the regression equation $Y = 79.669 + 0.209X_1 + 0.623X_2 - 0.075 X_3$ in a sample of 75 people.

However, based on the results of the regression test, the R^2 value is 0.181 or 18%. This shows that 18% of dollyo chagi

Analyze the Physical Performance of Elite Athletes: Relationship between Leg Muscle Explosive Power, Flexibility, and Balance in Elite Taekwondo Athletes Pre-Porprov West Java

kicks can be explained by the independent variables of explosive power, flexibility and balance. Meanwhile, the rest can be explained by other factors outside the research model. However, hypothesis is said to be accepted because there is a relationship between explosive power, flexibility, and balance.

ACKNOWLEDGMENTS

Based on the conclusions, implications and limitations that have occurred during the research process, there are several suggestions that will be given as input for coaches and sports practitioners, especially in the sport of taekwondo, namely:

1. To improve your dollyo chagi kicking skills, you can do this by increasing explosive power and flexibility training and balance.
2. In improving dollyo chagi kicking ability, both stomach and head targets must be adjusted to the magnitude of the relationship value of each variable to dollyo chagi kicking ability.
3. The creation of training programs must be thorough and in accordance with the needs of each individual.
4. It is hoped that the research results can become a reference and enrich research data related to the development of the kyorugi category in the sport of taekwondo.

REFERENCES

- 1) Apriantono, T., Herman, I., Winata, B., Hasan, M. F., Juniarsyah, A. D., Ihsani, S. I., Hidayat, I. I., Safei, I., & Hindawan, I. (2020). Differences of physiological characteristics of taekwondo junior players vs pencak silat junior players. *Physical Activity Review*, 8(2), 9–15. <https://doi.org/10.16926/par.2020.08.16>
- 2) Bompa, Tudor O.; Buzzichelli, C. (2019). Periodization : theory and methodology of training. In *Nuevos sistemas de comunicación e información*.
- 3) Chaabene, H., Negra, Y., Capranica, L., Bouguezzi, R., Hachana, Y., Rouahi, M. A., & Mkaouer, B. (2018). Validity and reliability of a new test of planned agility in elite taekwondo athletes. *The Journal of Strength & Conditioning Research*, 32(9), 2542–2547.
- 4) Di Domenico, F., D'isanto, T., & Raiola, G. (2019). Role of speed and agility in the effectiveness of motor performance. *Journal of Physical Education and Sport*, 19(5), 1836–1842. <https://doi.org/10.7752/jpes.2019.s5271>
- 5) Falaahudin, A., Admaja, A. T., & Iwandana, D. T. (2020). Level of physical fitness taekwondo UKM students. *Quality in Sport*, 6(1), 7–12. <https://doi.org/10.12775/qs.2020.001>
- 6) Gatsis, G., Strigas, A., & Ntasis, L. (2021). Contribution of emotional intelligence to taekwondo athlete's performance. *Journal of Physical Education and Sport*, 21(3), 1976–1980. <https://doi.org/10.7752/jpes.2021.s3251>
- 7) Kim, J. W., & Nam, S. S. (2021). Physical characteristics and physical fitness profiles of Korean taekwondo athletes: A systematic review. *International Journal of Environmental Research and Public Health*, 18(18). <https://doi.org/10.3390/ijerph18189624>
- 8) Lafanda, P., Purba, A., & Pandji, T. D. (2015). Physical Profile of West Java Taekwondo Athletes for Pekan Olahraga Nasional XVIII Riau. *Althea Medical Journal*, 2(2), 281–286.
- 9) Longo, A. F., Siffredi, C. R., Cardey, M. L., Aquilino, G. D., & Lentini, N. A. (2016). Age of peak performance in Olympic sports: A comparative research among disciplines. *Journal of Human Sport and Exercise*, 11(1), 31–41. <https://doi.org/10.14198/jhse.2016.111.03>
- 10) Mailapalli, D. R., Benton, J., & Woodward, T. W. (2015). Biomechanics of the Taekwondo axe kick: A review. *Journal of Human Sport and Exercise*, 10(1), 141–149. <https://doi.org/10.14198/jhse.2015.101.12>
- 11) Song, M.-H., & Yang, D.-S. (2019). The relationship between performance strategy, sport confidence and perceived performance of Taekwondo kyorugi players. *The World Society of Taekwondo Culture*, 32(23), 115–132. <https://doi.org/10.18789/jwstc.2019.23.115>
- 12) Tirtawirya, D., Rohendi Rohidi, T., & Indera Pamungkas, O. (2019). *The Eight-Weeks Physical Exercise Program In Maintaining Power On Taekwondo Athletes In The Competition Period*. 13. <https://doi.org/10.2991/icssh-18.2019.13>
- 13) Widiastuti. (2015). *Tes Dan Pengukuran Olahraga*. PT RAJA GRAFINDO PERSADA.
- 14) Yang, D.-S., Kim, K.-D., & Kang, H.-W. (2020). The Relationship among Positive Psychological Capital, Mental Toughness and Burnout on University Taekwondo Kyorugi Players. *The World Society of Taekwondo Culture*, 27(8), 187–202. <https://doi.org/10.18789/jwstc.2020.27.187>



There is an Open Access article, distributed under the term of the Creative Commons Attribution – Non Commercial 4.0 International (CC BY-NC 4.0)

(<https://creativecommons.org/licenses/by-nc/4.0/>), which permits remixing, adapting and building upon the work for non-commercial use, provided the original work is properly cited.

The Effectiveness of *Problem-Based Learning* Model on Creative Thinking Skills in Class V Elementary School in Wonogiri Sub-District



Sandra Bayu Kurniawan

Universitas Sebelas Maret, Solo, Indonesia

ABSTRACT: IPAS learning requires creative thinking skills in the teaching and learning process. This study aims to determine the effectiveness of the Problem Based Learning learning model on creative thinking skills in grade V IPAS subjects. This type of research is quantitative research. The research sample was 92 fifth grade students in Wonogiri sub-district public elementary schools. Data analysis was carried out using simple linear regression analysis techniques. The results showed the correlation value (R) = 0.471, meaning that there is a positive linear relationship between variables; the coefficient of determination R Square = 0.779, meaning that the Problem Based Learning learning model provides 77.9% influence on the effectiveness of creative thinking skills. The significant value of $0.000 < 0.05$ and the t value of $2.692 > t$ table 1.662, meaning that it accepts the alternative hypothesis. The research conclusion is that the Problem Based Learning learning model is effective in developing creative thinking skills in grade V IPAS subjects.

KEYWORDS: Problem Based learning, skills, creative thinking.

INTRODUCTION

Skills are a form of individual achievement. In the 21st century, skills are the focus for labeling or criteria for students. Asrori (2020) explains that skills are behaviors that are acquired through stages of learning. Meanwhile, according to Nasihudin and Hariyadin (2021) skills are the ability to carry out a particular task, both physically and mentally. This skill involves the use of thoughts, ideas, and creativity. Meanwhile, according to Zubaidah (2016), skills are abilities that are implemented in the implementation of work or activities. These skills are formed from experience and the learning process. Skills are the ability to perform specific tasks obtained through consistent practice. Skills do not appear automatically, but need to be developed deliberately through repeated practice (Hayati, 2018). Based on the opinions of the experts above, it can be concluded that skills are the ability to carry out certain tasks involving thoughts, ideas, and creativity that are formed based on experience or repeated practice.

Creative thinking can be defined as the ability to think to find, generate, develop original, aesthetic, constructive ideas or results related to views, concepts, where the emphasis is on intuitive and rational aspects of thinking, especially in using information and materials to bring up or explain them with the thinker's original perspective (Putra *et al.*, 2016). According to Agustina and Noor (2016), creative thinking is a person's ability to generate new, unique, and relevant ideas to solve problems or create something innovative. According to Situmorang *et al.* (2020), creative thinking is an individual activity to obtain a series of new and original ideas from concepts, experiences, and knowledge that have been obtained. Therefore, it can be synthesized that creative thinking skills are abilities obtained through stages of learning and experience to produce new and relevant ideas or ideas to solve problems or create innovative.

Creative thinking skills in primary school-age children are an important foundation for their growth and development. Creative thinking in learners can improve the ability to solve problems, brain development and thus improve overall cognitive abilities. In addition, creative thinking can also help learners to adapt to an ever-changing environment. According to Rizqi *et al.* (2021) creative thinking includes 4 aspects of ability including: (a) fluency, namely the ability to answer problems precisely; (b) flexibility, namely the ability to answer problems through non-standard ways; (c) originality, namely the ability to answer problems using your own language, methods, or ideas; and (d) elaboration, namely the ability to expand problem answers, raise new

The Effectiveness of Problem-Based Learning Model on Creative Thinking Skills in Class V Elementary School in Wonogiri Sub-District

problems or ideas. Therefore, it is necessary to foster creative thinking for students, especially at the elementary school level. Growing the creative thinking process of students requires an effective and efficient learning model. One of the learning models that can be used to foster creative thinking patterns is the *Problem Based Learning* (PBL) learning model.

The Problem Based Learning (PBL) model is a set of teaching models that use problems as a focus for developing problem-solving skills, materials, and self-regulation (Hasmyati, 2017). PBL is a learning approach that uses real-world problems as a context for students to learn about critical thinking, creative and problem-solving skills, as well as to gain essential knowledge and concepts from the subject matter (Nafiah, 2014). PBL is a learning model whose main starting point is the problem and how to solve it. This learning model emphasizes solving problems given by the teacher based on information that students have (Rahmasari, 2016).

Problem Based Learning (PBL) is a learning model in which students are faced with a real problem that has been experienced by students. Widiaworo (2018: 149) argues that the problem-based learning model is a teaching and learning process that presents contextual problems so that students are stimulated to learn. The problem is faced before the learning process takes place so that it can trigger students to research, describe and find solutions to the problem (Ardianti *et al.*, 2021). According to some of the above opinions, it can be synthesized that the *Problem Based Learning* (PBL) learning model is a learning model that uses problems that exist around the students' environment to foster critical and creative thinking patterns in order to solve or solve a problem given by the teacher. *The Problem Based Learning* (PBL) learning model has steps in the learning process, namely (Maryati, 2018): 1) Orienting students to the problem; 2) Organize students to research; 3) Assist independent and group investigations; 4) Develop and present work; and 5) Analyze and evaluate the problem-solving process. This learning model is expected to be able to foster the creative thinking process of students.

Based on the description above, this study can formulate the *problem* formulation, namely whether the *Problem Based Learning learning* model is effective on creative thinking skills in grade V IPAS subjects in Wonogiri sub-district public elementary schools. This study aims to determine the effectiveness of the *Problem Based Learning learning* model on creative thinking skills in grade V IPAS subjects.

METHODS

This research uses a type of quantitative research with a true experimental method. Quantitative research is an investigation of social problems based on testing a theory consisting of variables, measured by numbers, and analyzed by statistical procedures to determine whether the predictive generalizations of the theory are true (Creswell, 2022).

This study uses a population in the form of all fifth grade students in Wonogiri sub-district public schools. The sampling technique uses *random sampling* technique or random. The results of sampling obtained a total of 92 fifth grade students in Wonogiri sub-district State Elementary School. Data collection techniques with descriptive tests that have been tested for validity, reliability, level of size, and differentiating power. Data analysis used simple linear regression analysis and hypothesis testing with Independent Sample t-test to determine the effectiveness of the *Problem Based Learning learning* model on creative thinking skills.

RESULTS AND DISCUSSION

The results of the research on the effectiveness of the *Problem Based Learning learning* model on creative thinking skills in class V IPAS subjects in Wonogiri sub-district public elementary schools are described as follows:

Descriptive Statistical Analysis

Descriptive statistical analysis aims to provide an overall description of the data used in the study, by paying attention to the average value, standard deviation, variance, maximum value, minimum value and total.

Table 1. Table of Descriptive Statistical Test Results

Paired Samples Statistics		Mean	N	Mini mum	Maxi mum	Std. Deviation	Std. Error Mean
Teacher Professional	Pretest	58.78	6	42	81	11,3 45	2,5 67
	Posttest	80.56	6	67	98	10,9 86	2,2 48

Table 1 shows that the average pretest score of the experimental class is known to be different from the average posttest score. The average pretest score was 58.78 and the average posttest score was 80.56. The average score of the experimental class

The Effectiveness of Problem-Based Learning Model on Creative Thinking Skills in Class V Elementary School in Wonogiri Sub-District

increased by 21.78. Thus it can be concluded that the *Problem Based Learning learning* model has had a positive impact on the IPAS learning process in class V at State Elementary Schools in Wonogiri sub-district.

Simple Linear Regression Test

Simple linear regression test is a statistical method used to measure how much influence one variable (independent variable) has on another variable (dependent variable) in the form of a straight line. Based on the results of the SPSS output, it is known that the correlation value (r) between the independent variable of the *Project Based Learning* model and the dependent variable of students' creative thinking skills in class V IPAS lessons is 0.471. This can be interpreted that there is a positive linear relationship between the two variables, if the value of the independent variable increases, it is likely that the value of the dependent variable will also increase. In addition, this study has a coefficient of determination R Square = 0.779, meaning that the *Project Based Learning* model variable has an influence of 77.9% on the creative thinking skills of grade V students.

Prerequisite t test

Normality Test

Normality test is a statistical procedure used to test a data set that comes from a normally distributed population. The main purpose of the normality test is to validate the assumptions underlying various statistical analysis techniques. If the data is not normally distributed, then the analysis results obtained may be inaccurate or biased. Based on the results of the normality test using SPSS, it is known that the significance value is $0.093 > 0.05$, it can be concluded that the residual value is normally distributed.

Homogeneity Test

Homogeneity test is a statistical procedure used to test whether two or more groups of data have the same variance. The purpose of the homogeneity test is to determine whether the data comes from a population that has the same characteristics or not. Based on the homogeneity test, it can be seen that the statistical value of the homogeneity test in this study is $\chi^2_{count} (0.544) < \chi^2_{tabel} (3.841)$. The results of the homogeneity test calculation can be concluded that the sample population is homogeneous.

The t-test

This study uses a paired sample t-test to assess whether there is a difference in mean values between two samples that are paired or related to each other. The results of the homogeneity test can be seen in the following table.

Table 2. T Test Result

		Paired Differences					t	df	Sig.
		Mean	Std. Deviation	Std. Error Mean	95% Confidence Interval of the Difference				(2-tailed)
					Lower	Upper			
Pair 1	Pretest- Posttest	- 11,0 77	11,16 55	2,12 9	- 22,1 54	- 6,77 9	2,69 2	5	,000

Based on Table 2, it is known that the significant value for the effect of the *Project Based Learning* model variable on the creative thinking skills variable of students in IPAS lessons is $0.000 < 0.05$ and the t value is $2.692 > t$ table 1.662, so it can be concluded that H_a is accepted and H_0 is rejected, which means that there is an effect of the *Project Based Learning* model variable on the creative thinking skills variable of grade V students in IPAS lessons.

DISCUSSION

The results showed that the *Problem Based Learning* model was effective on creative thinking skills in class V IPAS subjects. It can be seen that this model has an influence of 77.9%. The learning model has a big influence on students' understanding. This is because the more appropriate the learning model used, the easier it is for students to receive material. Setyaningrum (2018) suggests that the *Problem Based Learning* (PBL) model is an approach that involves students in dealing with real problems from everyday life as the beginning of the learning process. In this way, students are invited to solve the problem, making it one of the innovative learning methods that encourage student activeness in learning and are expected to create meaningful learning experiences. In this model, the teacher acts as a motivator, facilitator and guide for students in the problem-solving process.

The Effectiveness of Problem-Based Learning Model on Creative Thinking Skills in Class V Elementary School in Wonogiri Sub-District

The Problem Based Learning (PBL) learning model has a positive impact on the creative thinking skills of students in grade 5 IPAS subjects. This can be seen in the average pretest score of 58.78 and the average posttest score of 80.56. The average experimental class score increased by 21.78. The PBL model has a positive impact which can help students think creatively in solving problems. As one of the variations of effective learning models, PBL makes it easier for students to understand the material being taught (Dewi *et al.*, 2023). *Problem-based learning* is proven to be effective and provides significant results in the learning process. This is because this model encourages students to work collaboratively in finding solutions to real problems that match the characteristics of PBL (Sari *et al.*, 2023).

Creative thinking skills will be formed if the learning model used can link the material with real experiences and contexts that are relevant to students. In addition, models that are interactive and encourage students' active participation in the learning process will also strengthen their understanding of the concepts taught. The learning model serves as a guide for educators in planning learning activities in the classroom, starting from the preparation of learning tools, media, and tools, to evaluation tools that aim to achieve learning objectives (Mirdad, 2020).

CONCLUSIONS

Based on the results of the study, it can be concluded that the *Problem Based Learning* (PBL) learning model on creative thinking skills in class V IPAS subjects is effectively applied in learning. This conclusion is based on the results of the average pretest score of 58.78 and the average posttest score of 80.56. The average experimental class score increased by 21.78. This shows a positive impact after the application of the PBL learning model.

REFERENCES

- 1) Agustina, W., and Noor, F. (2016). The relationship between learning outcomes and students' creative thinking level in mathematics learning. *Math Didactic: Journal of Mathematics Education*, 2(3), 191-200.
- 2) Ardianti, R., Sujarwanto, E., and Surahman, E. (2021). Problem-based Learning: What and How. *DIFFRACTION: Journal for Physics Education and Applied Physics*, 3(1), 27-35.
- 3) Asrori. (2020). *Educational Psychology (Multidisciplinary Approach)*. Central Java: CV. Pena Persada.
- 4) Creswell, J. (2022). *Research Design: Qualitative and Quantitative*. Approaches. London: SAGE Publications.
- 5) Dewi, C. K., Prayito, M., Purnamasari, I., & Kusniati, S. (2023). Analysis of PBL model assisted by concrete media on learning interest of third grade students of SDN Karanganyar Gunung 02. *Journal of Education and Counseling (JPDK)*, 5(2), 1508-1513.
- 6) Hasmyati, H. (2017). Application of *Problem Based Learning* (PBL) Learning Model in an Effort to Improve Physical Education Learning Outcomes of Basketball Material for Students of Class VIII-6 SMP Negeri 24 Makassar. In *National Seminar LP2M UNM* (Vol. 2, No. 1).
- 7) Hayati, I. R., & Sujadi, E. (2018). Differences in learning skills between science and social studies students. *Tarbawi: journal of education science*, 14(1), 1-10.
- 8) Maryati, I. (2018). Application of problem-based learning model on number pattern material in class vii junior high school. *Mosharafa: Journal of Mathematics Education*, 7(1), 63-74
- 9) Mirdad, J. (2020). Learning models (four families of learning models). *Journal of sakinah*, 2(1), 14-23.
- 10) Nafiah, Y. N. (2014). Application of Problem-Based Learning Model to Improve Critical Thinking Skills and Student Learning Outcomes. *Journal of Vocational Education*, 125-143.
- 11) Nasihudin and Hariyadin (2021). Skill Development in Learning. *Indonesian Journal of Education*, 2(4), 733-743.
- 12) Puspitasari, L. (2012). The Effect of *Problem Based Learning* Model on Creative Thinking Ability of Biology Class X Students of SMA Negeri 2 Surakarta in 2011/2012. *Thesis*. Faculty of Teacher Training and Education, Sebelas Maret University
- 13) Putra, R. D., Rinanto, Y., Dwiastuti, S., & Irfa, I. (2016). The Increasing of Students Creative Thinking Ability Through of Inquiry Learni Guided Learning Model in Class XI MIA 1 SMA Negeri Colomadu Karanganyar Study Year 2015 / 2016 The Increasing of Students Creative Thinking Ability Through of Inquiry Learni. *Proceeding Biology Education Conference*. Surakarta, 13(1), 330-334
- 14) Rahmasari, R. (2016). Application of *Problem Based Learning* Model to Improve Learning Outcomes of Class IV Elementary School. *Journal of Elementary School Teacher Education 36th Edition 5th Year*.
- 15) Rizqi, M., H. Suyitno, and D. Dwijanto. (2021). Students' Mathematical Creative Thinking Ability in terms of Learning Styles and Gender in *Problem Based Learning*. *Unnes Journal of Mathematics Education Research*, 10(1), 24-34. 2021

The Effectiveness of Problem-Based Learning Model on Creative Thinking Skills in Class V Elementary School in Wonogiri Sub-District

- 16) Sari, I. P., Nanto, D., & Putri, A. A. (2022). The effect of students' physics education learning outcomes using meta-analysis techniques with the PBL (*Problem Based Learning*) model. *MENTARI Journal: Management, Education and Information Technology*, 1(1), 20-28.
- 17) Setyaningrum, M. (2018). Improving learning outcomes using the *Problem Based Learning* (PBL) model for 5th grade students. *Journal of Technology Research and Educational Innovation (JARTIKA)*, 1(2), 99-108.
- 18) Situmorang, A., Napitupulu, E., and Wahyuningrum, E. (2023). The effect of realistic mathematics learning approach and learning motivation on creative thinking skills of fifth grade students. *Journal of Educational Technology (JTP)*, 16(1), 1-8.
- 19) Widiaworo, E. (2018). *Character-based edutainment learning strategies (1st ed.)*. Yogyakarta, Indonesia: Ar-Ruzz Media.
- 20) Zubaidah, S. (2016). Skills that are taught through learning. *National Seminar on Education with the theme "Strategic Issues in Mathematics and Natural Sciences Learning in the Century"*, 21(10).



There is an Open Access article, distributed under the term of the Creative Commons Attribution – Non Commercial 4.0 International (CC BY-NC 4.0) (<https://creativecommons.org/licenses/by-nc/4.0/>), which permits remixing, adapting and building upon the work for non-commercial use, provided the original work is properly cited.

Retrospective Study of Fine Needle Aspiration Cytology of Patients with Thyroid Nodule in Benghazi in the Period of (2021-2023)



Lobna Abdalla Elfrgani¹, Ghazala Othman Ali Elfeitouri², Mona Adnan Elkhattib³,
Mona Moftah Alabbar³, Salha Abdullah Alobidy³, Sally Ali khalaf³, Abeer H. Amer¹

¹Histology Department, Faculty of Medicine, University of Benghazi

²Medicine Department, Faculty of Medicine, University of Benghazi

³Cytotechnology Department, Faculty of Biomedical sciences, University of Benghazi

ABSTRACT

Background: Thyroid nodules constitute a common endocrine disorder, these nodules could be solitary, multiple, cystic, or solid. Increasing age, female gender, iodine deficiency, and history of thyroid radiation all are high risk for thyroid nodules. FNAC representing the most cost-effective diagnostic tool used in the assessment of nodules of the thyroid.

Objective of the study: The aim of this study is to evaluate the result of fine needle aspiration cytology (FNAC) and assess thyroid status using of thyroid hormone obtained from patients with thyroid nodules.

Materials and methods: this is a retrospective study, includes collection of data from available cases of thyroid nodules underwent fine needle aspiration between 2021 to 2023, data regarding age, sex, TFT, USS, FNAC was collected from the archive of endocrine out patients clinic of Benghazi Medical Center and from endocrine clinic of Benghazi diabetic center. The analysis was done using the SPSS program.

Result: A total of 60 cases were studied, Data was collected from 60 patient's files for years between 2021 and 2023. The mean age of the patients with FNAC selected for this study was 49.65, and ranged from 21-80 years. The gender distribution shows female predominance in which female cases were 53 (98.33%) while only one case (1.67%) was reported among men. The size of nodules in our cases range from 1cm to 4.5 cm. The mean size of nodules is 1.89cm. In this study the largest group of nodules located in right lobe (21) cases then left lobe (20) cases then both (17) cases and in isthmus only 2 cases. Most of the cases thyroid function test result shows an euthyroid status (38) cases. FNAC of thyroid nodule showed that most of patient's result diagnosed as benign nodules (47) cases.

Conclusion: FNAC is a key tool in diagnosis of thyroid nodule as it has safe, minimally invasive and cost effective diagnostic role.

INTRODUCTION

According to the American Thyroid Association (ATA) the thyroid nodule is a discrete lesion within the thyroid gland. (1) Thyroid nodules can vary in nature, appearing as solitary, multiple, cystic, or solid formations. They are quite common, being detected in approximately 5% to 7% of the adult population. These nodules can be classified as either neoplastic or non-neoplastic. Neoplastic nodules are further classified to either benign or malignant. While the majority of detected nodules are clinically insignificant benign ones, accounting for more than 90% of cases, thyroid cancer can be found in approximately 4.0% to 6.5% of cases. This emphasizes the clinical significance of investigating thyroid nodules. (2) On the other hand, non-neoplastic nodules encompass hyperplastic and inflammatory nodules. Colloid nodules are the most common type of thyroid nodules and they represent benign adenomatous neoplasms. Non-medullary thyroid cancers are a type of thyroid carcinoma that arises from epithelial cells, constituting approximately 95% of cases. It's worth noting that twenty percent of medullary thyroid carcinomas are hereditary and may occur as part of multiple endocrine neoplasia syndromes. (2)(3)

Retrospective Study of Fine Needle Aspiration Cytology of Patients with Thyroid Nodule in Benghazi in the Period of (2021-2023)

The prevalence of thyroid nodules varies depending on the method of screening and the specific population being evaluated. Factors such as increasing age, being female, having iron deficiency, and a history of thyroid radiation all contribute to a higher risk of developing thyroid nodules. (4) Additionally, individuals who are long-term survivors of hematopoietic stem cell transplantation are at a greater risk for secondary thyroid carcinoma, with a relative risk of 3.26. (2) (5)

Thyroid nodules are found to be nearly four times more prevalent in women compared to men and are more frequently observed in populations residing in regions with iodine deficiency. A surveillance study conducted over a span of 20 years estimated the prevalence rates to be 0.8% for men and 5.3% for women.(6) Furthermore, the incidence of cancer associated with these nodules is significantly higher in men, with rates of 8% in men versus 4% in women.(7)

Fine Needle Aspiration (FNA) serves as the fundamental method for evaluating thyroid nodules, being the most economical diagnostic approach for assessing these nodules. This procedure is conducted with the assistance of ultrasound guidance. The decision to carry out an FNA should take into account the individual risk factors, the patient's medical history, and both clinical and ultrasound findings. From a technical perspective, nodules measuring less than one 1cm are subjected to biopsy if there are multiple suspicious ultrasound characteristics, the presence of cervical lymphadenopathy, or a history that indicates high risk. (2)(8)(9)

Aim: The aim of this study is to evaluate the result of fine needle aspiration cytology (FNAC) and assess thyroid status using of thyroid hormone obtained from patients with thyroid nodules.

MATERIAL AND METHODS

Patients and study design: A retrospective study was conducted in relation to 60 patients diagnosed with thyroid nodule. Patient's medical records in the archives of endocrine out patient's clinic of Benghazi Medical Center and of endocrine clinic of Benghazi diabetic center within the period of 2021 to 2023 were reviewed to obtain the following data: age, sex, T3, T4, TSH, size, site of nodule and FNAC result.

Statistical analysis: Data was processed using microsoft Excel 2010 then coded and processed on IBM compatible computer, using the statistical package for social science (SPSS) software (version 26) for statistical analysis.

Result:

Data was collected from 60 patient's files for years between 2021 and 2023. The mean age of the patients with FNAC selected for this study was 49.65, and ranged from 21-80 years. Age distribution for all cases is shown in (figure 1). In this study gender distribution shows female predominance in which female cases were 59 (98.33%) while only one case (1.67%) was reported among men (Figure 2). The size of nodules in our cases range from 1cm to 4.5 cm. The mean size of nodules is 1.89 cm (Figure 3). In this study the largest group of nodules located in right lobe with 21 cases then left lobe with 20 cases then both with 17 cases and last one in isthmus with only 2 cases (figure 4). In the majority of cases thyroid function test result shows an euthyroid status (38) cases; where normal range reference for euthyroid was TSH 0.45 to 4.49 ml U/L (Figure 5). In regards to FNAC of thyroid nodule the result showed that most of patient diagnosed as benign nodules (57) cases and only (3) cases with malignant lesion. Details of benign lesion is shown in (figure 6) and (table 1).

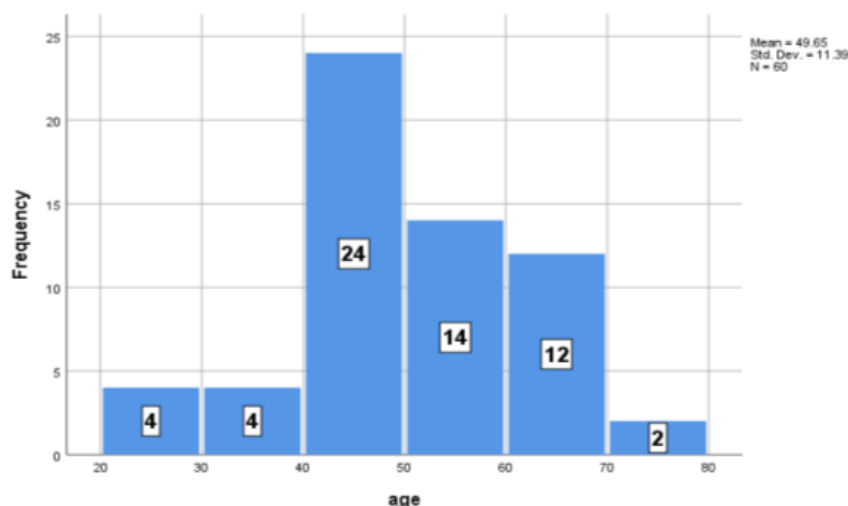

Figure1. Patient's age distribution.

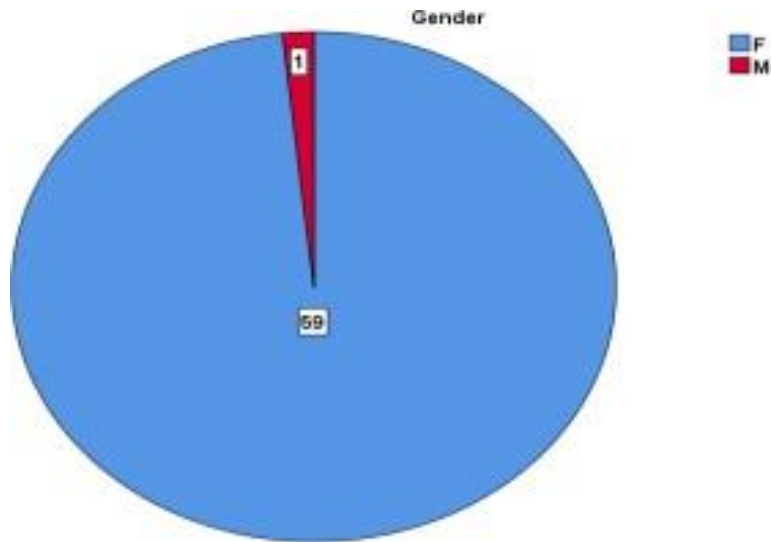

Figure 2. gender of patients

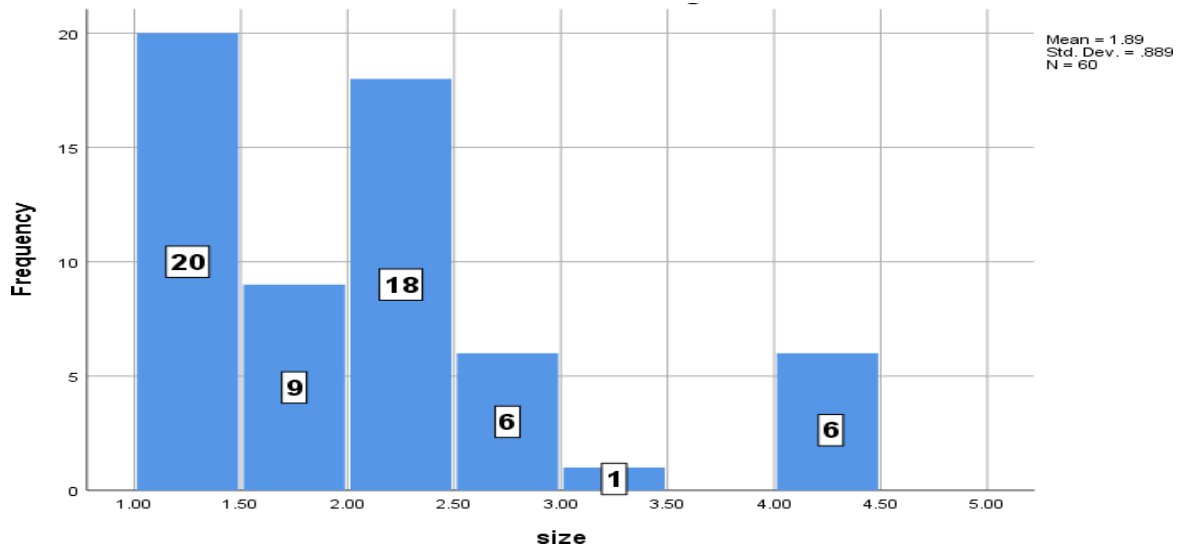

Figure 3. Size (per cm) of the nodules

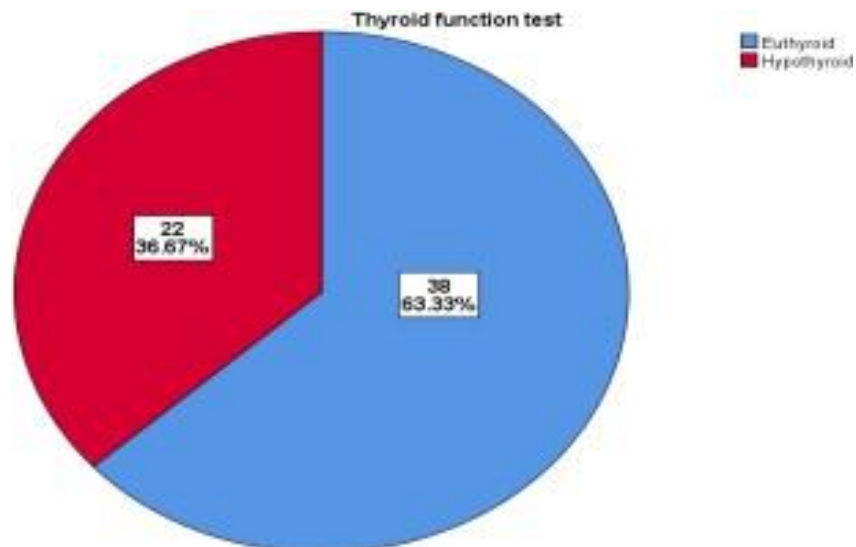

Figure 4. Thyroid function test status of patients

Retrospective Study of Fine Needle Aspiration Cytology of Patients with Thyroid Nodule in Benghazi in the Period of (2021-2023)

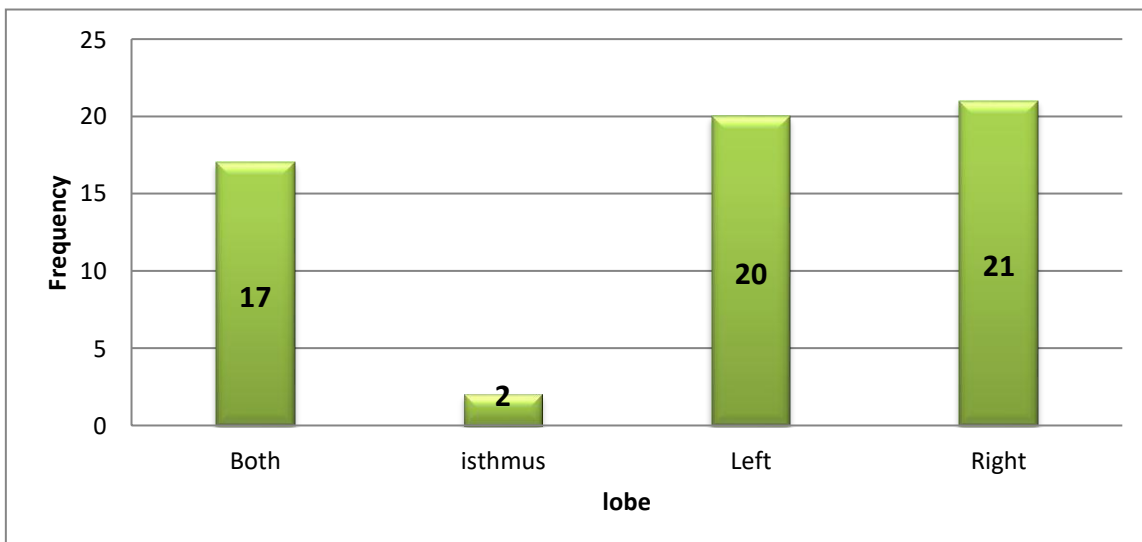

Figure 5. Site of the lesion

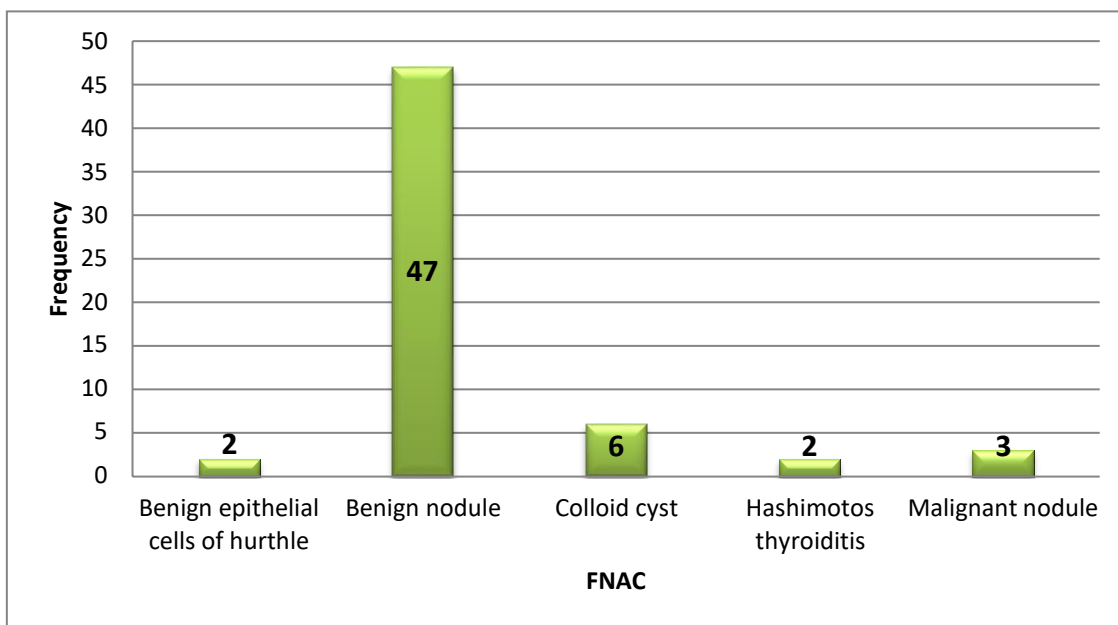

Figure 6. FNAC result

Table 1 shows FNAC result

FNAC	Frequency	Percent%
Benign epithelial cells of hurthle	2	3.3
Benign nodule	47	78.3
Colloid cyst	6	10.0
Hashimotos thyroiditis	2	3.3
Malignant nodule	3	5.0
Total	60	100.0

DISCUSSION

Thyroid nodules are a common clinical issue. Its incidence has been increased in population, specifically in middle-aged women. Early diagnosis plays a vital role in enhancing life expectancy, due to the low malignant potential of thyroid nodules, and slow progressing characteristics of thyroid gland cancers. This study assesses the application of Fine Needle Aspiration Cytology (FNAC) techniques, which are characterized by their simplicity, speed, ease of repetition, and non-invasive nature. This diagnostic method

Retrospective Study of Fine Needle Aspiration Cytology of Patients with Thyroid Nodule in Benghazi in the Period of (2021-2023)

is capable of identifying both benign and malignant lesions, utilizing ultrasound guidelines to minimize unnecessary surgical procedures. The study was conducted in relation to 60 cases to evaluate thyroid nodules in Benghazi.

In this study, the age of patients ranged from 21 to 80 years with mean age 49.65 with female predominance. Most of the available research in literature are in accordance in that the percentage of female is higher than male with similar age distribution; approximate range was found by Bahaj et al. study (10) which reported (81%) females and (19%) male with thyroid nodules and mean age 42 years. Further similarity was found in Abeer et al. Study (11) that shows female predominance (90%) while male (10%) and mean age was 51.5. In the same context the mean age in a study of Park et al. (12) is 50 years. In contrast, the mean age in the studies of Bachir et al. Study (13) is 40 years, Naz et al. (14) is 39.7, Gupta et al. (15) is 38.7, and Bhat et al. (16) is 36; which are lower as compared with our study and other reported series. However; all listed studies show female predominance. Similar to our study benign pathology including colloid nodular goiter, follicular lesion, Hurthle cell lesion, and Hashimoto's thyroiditis are reported as the common lesions of thyroid nodules in most of the research Dhamecha et al. (17), Patel et al. (18) Abeer et al. (11) and Handa et al. (19).

For the evaluation of patients presenting with thyroid nodules, the measurement of thyroid-stimulating hormone (TSH) should be the first diagnostic test conducted and utilized to inform subsequent management decisions. An elevated or normal TSH level often heightens the suspicion of malignancy, as the likelihood of cancer correlates positively with serum TSH levels. Conversely, a low TSH level typically suggests a benign nature of the nodule (2). However, in the current study majority of cases are benign nodule and show euthyroid status; and further the 3 malignant cases are euthyroid.

The assessment of nodule dimensions and the likelihood of malignancy continues to be a compelling field of study. Study of Cavallo et al. (20) shows that the size of thyroid nodule is inversely associated with the risk of malignancy, indicating that larger nodules tend to exhibit lower rates of malignancy. Consistent with the study of Al-Hakami et al. (21) where highest malignancy risk was observed in nodules <2 cm and no increase in malignancy risk for nodules >2 cm. However; for the cases diagnosed as malignant nodule in this study; the size is 2.5cm for two cases and 4.5cm for the other case, for benign nodules result shows that in most of cases the size ranges from 1cm to 1.5 cm (20 cases) and from 2cm to 2.5 cm (18cases). Study of Jinih et al. (22) indicates that the size of a thyroid nodule is not a reliable indicator of the risk of thyroid cancer.

6. CONCLUSION

FNAC is a gold standard method for evaluation of thyroid nodules and guide its management. Cases results were mostly euthyroid benign nodule with female predominance. In the future more research is required to enrich the performance of FNAC and document a good data for future management review and research. To determine the sensitivity, specificity, and accuracy of FNAC result it is better to be compared in relation to histopathological findings.

REFERENCE

- 1) Haugen, B. R., Alexander, E. K., Bible, K. C., Doherty (2016). 2015 American Thyroid Association Management Guidelines for Adult Patients with Thyroid Nodules and Differentiated Thyroid Cancer: The American Thyroid Association Guidelines Task Force on Thyroid Nodules and Differentiated Thyroid Cancer. *Thyroid : official journal of the American Thyroid Association*, 26(1), 1–133.
- 2) Zamora EA, Khare S, Cassaro S. Thyroid Nodule. [Updated 2022 Sep 5]. In: StatPearls [Internet]. Treasure Island (FL): StatPearls Publishing; 2023 Jan-.
- 3) Yeung, M. J., & Serpell, J. W. (2008). Management of the solitary thyroid nodule. *The oncologist*, 13(2), 105–112. <https://doi.org/10.1634/theoncologist.2007-0212>
- 4) Dean DS, Gharib H. (2008) Epidemiology of thyroid nodules. *Best Pract Res Clin Endocrinol Metab.* 22(6):901-11.
- 5) Cohen A, Rovelli A, Merlo DF, van Lint MT, Lanino E, Bresters D, Ceppi M, Bocchini V, Tichelli A, Socié G. (2007). Risk for secondary thyroid carcinoma after hematopoietic stem-cell transplantation: an EBMT Late Effects Working Party Study. *J Clin Oncol.* 10;25(17):2449-54.
- 6) Welker MJ, Orlov D. (2003). Thyroid nodules. *Am Fam Physician.* 01;67(3):559-66.
- 7) Belfiore A, La Rosa GL, La Porta GA, Giuffrida D, Milazzo G, Lupo L, Regalbuto C, Vigneri R. 1992 Oct; Cancer risk in patients with cold thyroid nodules: relevance of iodine intake, sex, age, and multinodularity. *Am J Med.* 93(4):363-9.
- 8) Popoveniuc G, Jonklaas J. (2012) Thyroid nodules. *Med Clin North Am* ;96(2):329-49.
- 9) Elmatri, H. H., Gheryani, N. A., Saad, R. H. F. and Amer, A. H. A. (2024) Perioperative Diagnosis of Thyroid Lesions through Fine-Needle Aspiration: A Clinicopathological Retrospective Analysis. *Libyan International Medical University Journal*, 9 (1).

Retrospective Study of Fine Needle Aspiration Cytology of Patients with Thyroid Nodule in Benghazi in the Period of (2021-2023)

- 10) Bahaj, A. S., Alkaff, H. H., Melebari, B. N., Melebari, A. N., Sayed, S. I., Mujtaba, S. S., (2020). Role of fine-needle aspiration cytology in evaluating thyroid nodules. A retrospective study from a tertiary care center of Western region, Saudi Arabia. *Saudi medical journal*, 41(10), 1098–1103.
- 11) Abeer H. A. Amer, Amina B. M. Younis, Muftah S. El saeiti, Nabeia Gheryani (2022). Histological Characters of Thyroid Nodules in Patients that Underwent Thyroid Surgery in Endocrine Clinic at Alkeesh Polyclinic in Benghazi – Libya within the years 2014 - 2020. *Benghazi University Medical Journal BUMJ 2 (2)*, 103-112,2022.
- 12) Park, J. H., Yoon, S. O., Son, E. J., Kim, H. M., Nahm, J. H., & Hong, S. (2014). Incidence and malignancy rates of diagnoses in the Bethesda system for reporting thyroid aspiration cytology: an institutional experience. *Korean journal of pathology*, 48(2), 133–139.
- 13) Bchir, A., Bdioui, A., Zammel, H., Missaoui, N., Hmissa, S., & Mokni, M. (2021). The importance of using fine-needle aspiration cytology in the diagnosis of thyroid nodules. *Annals of medicine and surgery (2012)*, 63, 102153.
- 14) Naz, S., Hashmi, A. A., Faridi, N., Edhi, M. M., Kamal, A., & Khan, M. (2014). Diagnostic accuracy of Bethesda system for reporting thyroid cytopathology: an institutional perspective. *International archives of medicine*, 7(1), 1-5.
- 15) Gupta, M., Gupta, S., & Gupta, V. B. (2010). Correlation of fine needle aspiration cytology with histopathology in the diagnosis of solitary thyroid nodule. *Journal of thyroid research*, 2010, 379051.
- 16) Bhat, S., Bhat, N., Bashir, H., Farooq, S., Reshi, R., Nazeir, M. J., & Niyaz, I. (2016). The Bethesda system for reporting thyroid cytopathology: a two year institutional audit. *International Journal of Current Research and Review*, 8(6), 5.
- 17) Dhamecha, M. P., Swami, S. Y., & Valand, A. G. (2018). FNAC study of thyroid lesions using the Bethesda system. *Trop J Path Micro*, 4, 101-108.
- 18) Patel, K. A., Anandani, G., Sharma, B. S., & Parmar, R. A. (2023). Study of Fine Needle Aspiration Cytology (FNAC) of Thyroid Gland According to the Bethesda System. *Cureus*, 15(4), e37371.
- 19) Handa, U., Garg, S., Mohan, H., & Nagarkar, N. (2008). Role of fine needle aspiration cytology in diagnosis and management of thyroid lesions: A study on 434 patients. *Journal of cytology*, 25(1), 13-17.
- 20) Cavallo, A., Johnson, D. N., White, M. G., Siddiqui, S., Antic, T., Mathew, M., Grogan, R. H., Angelos, P., Kaplan, E. L., & Cipriani, N. A. (2017). Thyroid Nodule Size at Ultrasound as a Predictor of Malignancy and Final Pathologic Size. *Thyroid: official journal of the American Thyroid Association*, 27(5), 641–650.
- 21) Al-Hakami, H. A., Alqahtani, R., Alahmadi, A., Almutairi, D., Algarni, M., & Alandejani, T. (2020). Thyroid Nodule Size and Prediction of Cancer: A Study at Tertiary Care Hospital in Saudi Arabia. *Cureus*, 12(3), e7478.
- 22) Jinih, M., Faisal, F., Abdalla, K., Majeed, M., Achakzai, A. A., Heffron, C., McCarthy, J., & Redmond, H. P. (2020). Association between thyroid nodule size and malignancy rate. *Annals of the Royal College of Surgeons of England*, 102(1), 43–48.



There is an Open Access article, distributed under the term of the Creative Commons Attribution – Non Commercial 4.0 International (CC BY-NC 4.0) (<https://creativecommons.org/licenses/by-nc/4.0/>), which permits remixing, adapting and building upon the work for non-commercial use, provided the original work is properly cited.

Assessment of Land Damage Status Using Frequency Method on Several Land Use for Biomass Production in Payakumbuh City



Aprisal¹, Teguh Haria Aditya², Resin³

¹Soil Science Department Agriculture faculty, Andalas University

²Forestry Faculty Muhamadya University

³Student of Chemistry Masters Andalas University

ABSTRACT: Intensive use of land for agricultural businesses causes the land to become very dynamic and causes a decrease in soil quality for producing biomass. This research aims to determine environmental conditions (level of damage to land and soil for biomass production) and the factors that cause soil damage in Payakumbuh City. Land surveys were carried out using the research method in five sub-districts. Samples taken in the field are disturbed soil samples for analysis of physical properties (*texture, BV, TRP, and permeability*). In contrast, disturbed soil samples are used to analyze chemical soil properties (*c.organic, pH, DLH, Redok*). Apart from that, he also observed environmental conditions such as rocks on the surface and the depth of the soil. Next, the soil samples are explained in the soil laboratory of the Department of Soil Science and Land Resources. Data from soil physical and chemical property variables are processed, averaged, and compared with soil health standards following PP No. 150 of 2000. The research results show that the results of land identification and verification show that the land in the five sub-districts of Payakumbuh City in the research area has a Light Damage Status (RI) covering an area of 2391.65 ha and Moderate Damage (RII) covering an area of 1856.76 ha. From 10 observation points, the land in the research area has two levels of soil damage: moderate and light. Soil damage is caused by limiting factors. In moderate damage status, the limiting factors are (RII-vpre), namely soil porosity, degree of air escape, redox reactions, and electrical conductivity. Meanwhile, the limiting factors in soil with mild damage are (RI-vre) soil porosity, redox reactions, and electrical conductivity.

KEYWORDS: soil degradation, biomass, soil properties, damage

INTRODUCTION

Background

The basis of national development policies implemented so far is aimed at sustainable and environmentally sound development. This development pattern means seeking the best results from available natural resources by preserving the quality and potential of these natural resources throughout the ages. Therefore, the threat of environmental damage must continue to be monitored, both by the government as a policy maker and by practitioners from all elements of society.

Deforestation and land degradation have significant impacts, ranging from decreasing biodiversity, floods, landslides, droughts, decreasing water and soil quality to the global climate change that we are currently facing. Industrial development in agricultural areas has reduced the area of productive agricultural land and also polluted the land and water bodies. As a result, the quality and quantity of agricultural products decreases, as well as causing discomfort and health problems for humans or other living creatures. Agricultural activities can also have negative impacts. [Aprisal et al., 2019]. Soil erosion and damage occurs due to agricultural cultivation that exceeds the carrying capacity of the soil (Bekele, 2019) and its ecosystem. Apart from that, excessive use of chemical fertilizers can also result in water and soil pollution and reduce soil fertility. Based on research conducted, the sustainability of biomass production is greatly influenced by soil conditions and damage. Damaged soil can inhibit the growth and productivity of biomass plants.

Damaged soil can have poor physical, chemical, and biological qualities, such as rapid soil structure, inappropriate pH, and low organic matter content. Apart from that, soil damage can also result in erosion which ultimately affects soil fertility and groundwater availability. Soil damage can also affect the soil nutrient cycle, so that plant biomass will have difficulty getting the

Assessment of Land Damage Status Using Frequency Method on Several Land Use for Biomass Production in Payakumbuh City

nutrients needed for growth. Therefore, to assess soil conditions more comprehensively, it is necessary to carry out an assessment that covers various aspects, from physical, chemical, to soil biology quality (Basak et al., 2021)

The development of industrial areas in agricultural areas and their surroundings has reduced the area of productive agricultural land and polluted the land and water bodies. As a result, the quality and quantity of agricultural products has decreased, causing disruption to human comfort and the welfare of other living creatures. Agricultural activities can also have detrimental impacts – excessive farming causes erosion and soil damage that exceeds the carrying capacity of the land and ecosystem. In addition, excessive use of chemical fertilizers can result in water and soil pollution. Apart from that, it is also necessary to consider external factors such as land use, fertilizer use, and irrigation techniques which can affect long-term soil health and the sustainability of biomass production (Environmental Sustainability, 2023). Excessive use of agrochemicals can pollute the environment and disrupt land sustainability. Agricultural cultivation methods that do not heed land conservation principles cause land quality to decline in line with the loss of fertile soil layers due to erosion and leaching of nutrients. Land and environmental damage increases when agricultural areas are expanded to develop economic commodities by opening up new land that is not in accordance with the capabilities and suitability class of the land. Soil as a natural resource, living area, environmental medium and production factor including biomass production which supports human life and other living creatures must be protected and its sustainability is maintained (Basak et al., 2021)

An environmental problem that continues and is increasingly becoming a serious concern that we can look at together is land use that does not pay attention to soil conservation aspects, thereby accelerating the degradation of soil fertility levels. This problem is not only the responsibility of the Regional Government with all its policies, but must also be the responsibility of all elements of society in Payakumbuh City. Law Number 32 of 2009 concerning Environmental Protection and Management explains that basically everyone is obliged to maintain the preservation of environmental functions and prevent and overcome environmental pollution and damage. The influence on the environment can be a disturbance of the balance of the ecosystem which supports life, experiencing changes and even damage due to activities and processes such as pollution and so on. In terms of biomass production, soil damage can disrupt the balance of the ecosystem and cause perspiration (Kardol et al., 2018). The aim of this research is to determine environmental conditions (level of land damage and/or land for biomass production), to determine the factors that cause land damage in Payakumbuh City.

MATERIALS AND METHODS

Determining Study Locations

The study of the status of land damage for biomass production in Payakumbuh City in 2022 covers five sub-districts, namely; East Payakumbuh District, North Payakumbuh District, West Payakumbuh District, South Payakumbuh District, and Payakumbuh Lamposi Tigo Nagari District. More details can be seen at Table 1. the following.

Table 1. Sampling Location for Payakumbuh City Study Area

No	Sample Code	Administration Location		Geographical Position	
		Subdistrict	Ward	L.S	BT
1	KPY S1	South District	Payakumbuh Limbukan	0°15'57.30" S	100°36'53.90" E
2	KPY S2	South District	Payakumbuh Padang Kerabi	0°15' 8.20" S	100°37'41.80" E
3	KPY T1	East District	Payakumbuh Batimah Hall	0°13'17.10" S	100°39'36.80" E
4	KPY T2	East District	Payakumbuh Payobasung	0°12'28.20" S	100°39'37.20" E
5	KPY U1	North District	Payakumbuh Taruko	0°12'31.30" S	100° 39' 9.70" E
6	KPY U2	North District	Payakumbuh Talawi	0°11'14.40" S	100°38'8.30" E

Assessment of Land Damage Status Using Frequency Method on Several Land Use for Biomass Production in Payakumbuh City

7	KPY LS1	Payakumbuh Lamposi Tigo Nagari District	Durian River	0°11'57.50" S 100°36'54.50" E
8	KPY LS2	Payakumbuh Lamposi Tigo Nagari District	Padang Sikabu	0°12'43.46" S 100°36'38.76" E
9	KPY B1	West Payakumbuh District	Gutter	0°13'41.60" S 100°35'45.20" E
10	KPY B2	West Payakumbuh District	Gutter	0°13'51.50" S 100°35'41.30" E

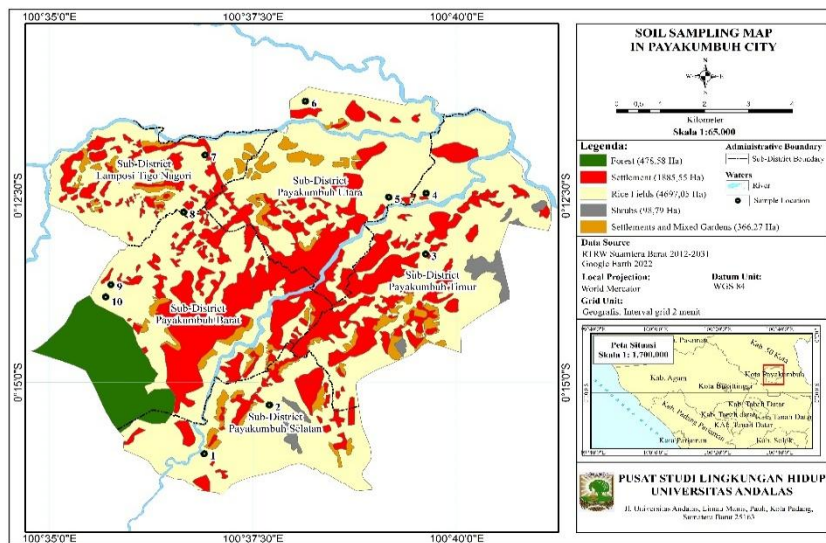

Figure 1. Map of sample points for potential soil damage in five sub-districts in Payakumbuh City

Primary Data Collection

Primary data collection is taking soil samples at predetermined locations. The soil samples taken consist of:

- Undisturbed soil samples were taken using a sample ring. Soil samples are needed to determine bulk density (BI), total porosity and degree of water flow (permeability).
- Disturbed soil samples were taken using a mineral drill. Representative soil samples for designated locations are carried out compositely. Incomplete soil samples are needed to determine texture, pH (H₂O), DHL redox, and microbial counts.

Laboratory soil analysis

Soil parameters for dry land as regulated in Minister of the Environment Regulation No. 7 of 2006 concerning Procedures for Measuring Land Damage Criteria for Biomass Production include: Solum Thickness, Surface Unity, Fractional Composition, Bulk Density, Total Porosity, Degree of Water Permeability, pH. Electrical Conductivity, Redox Value, Number of Soil Microbes (Table 2).

Table 2. Standard Criteria for Soil Damage in Dry Land

No	Parameter	Critical Threshold (PP 150/2000)	Unit of Observation/Analysis Results	Measurement Method
1	Solum Thickness	< 20 cm	cm	Direct Measurement
2	Surface Rockery	> 40 %	%	Direct measurement of rock balance and land area units
3	Fraction Composition	< 18 % colloid ; > 80% quartzite sand	%	Gravimetrics and Texture Analysis

Assessment of Land Damage Status Using Frequency Method on Several Land Use for Biomass Production in Payakumbuh City

4	Content Weight	> 1.4 g/cm ³	g/cm ³	Gravimetric
5	Total Porosity	< 30 % ; > 70 %	%	Calculation of Fill Weight (BI) and Specific Gravity (BJ)
6	Degree of Water Release	< 0.7 cm/hour; > 8.0 cm/hour	cm/hour	Permeameter uses Darcy's Law
7	pH (H ₂ O) 1 : 2.5	< 4.5 ; > 8.5		Potentiometric
8	Electrical Conductivity / DHL	> 4.0 mS/cm	mS/cm	Electrical resistance with EC meter equipment
9	Redox	< 200 mV	mV	Electrical voltage with pH meter equipment and platinum electrodes
10	Number of Microbes	< 10 ²	cfu/g soil	Petridis and coloni counter
11	Soil erosion <ul style="list-style-type: none"> • Solum < 20 • Solum 20 - 49 • Solum 50 – 99 • Solum 100-150 • Solum > 150 	< 1 1 – 2.9 3 – 6.9 7 – 9 > 9	tons/ha/year	Direct observation in the field

Table 3. Assessment of Potential Soil Damage Based on Soil Type

No	Land	Potential Soil Damage	Symbol	Ratings	Weighting (Rating x Weight)	Score
1	Vertisol, Soil with aquic moisture regime	Very Light	T1	1	2	
2	Oxisols	Light	T2	2	4	
3	Alfisols, Molisols, Ultisols	Currently	T3	3	6	
4	Inceptisols, Entisols, Histosols	Tall	T4	4	8	
5	Spodosols, Andisols	Very high	T5	5	10	

Table 4. Assessment of Potential Soil Damage Based on Land Slope

No	Slope (%)	Potential Soil Damage	Soil Symbol	Ratings	Weighting (Rating x Weight)	Score
1	1 – 8	Very Light	L.1	1	3	
2	9 – 15	Light	L.2	2	6	
3	16 – 25	Currently	L.3	3	9	
4	26 – 40	Tall	L.4	4	12	
5	>40	Very high	L.5	5	15	

Assessment of Land Damage Status Using Frequency Method on Several Land Use for Biomass Production in Payakumbuh City

Table 5. Assessment of Potential Soil Damage Based on Annual Rainfall

No	Rainfall (mm)	Potential Damage	Soil	Symbol	Ratings	Weighting (Rating x Weight)	Score
1	<1000	Very low		H1	1	3	
2	1000 – 2000	Low		H2	2	6	
3	2000 – 3000	Currently		H3	3	9	
4	3000 – 4000	Tall		H4	4	12	
5	>4000	Very high		H5	5	15	

Table 6. Assessment of Potential Soil Damage Based on Land Use Type

No	Land Use	Potential Damage	Soil	Symbol	Ratings	Weighting (Rating x Weight)	Score
1	Natural forests, rice fields, pure reeds	Very low		T1	1	2	
2	Mixed gardens, bushland, meadows	Low		T2	2	4	
3	Production forest, Farming	Currently		T3	3	6	
4	Moorland (annual plants)	Tall		T4	4	8	

Table 7. Criteria for Classification of Potential Soil Damage Classes Based on Score Values

No	Symbol	Potential Soil Damage	Weighting Score
1	PR I	Very low	<15
2	PR II	Low	15 – 24
3	Homework III	Currently	25 – 34
4	PR IV	Tall	35 – 44
5	PR V	Very high	– 50

Soil Damage Status for Biomass Production

Evaluation of soil damage status for biomass production is carried out through 2 stages as follows:

a. Matching Method

The Matching method is to compare the measured soil damage parameter data with standard soil damage criteria for Biomass Production based on Government Regulation No. 150 of 2000 or (Table 3, 4, 5, 6, and 7).

b. Soil Damage Frequency Scoring Method.

The scoring method is carried out by considering the relative frequency of those classified as damaged in a polygon. The relative frequency of soil damage (%) is the percentage value of soil damage based on a comparison of the number of damaged soil samples, namely the results of measuring each parameter of soil damage according to standard criteria for soil damage quality.

The steps in determining land damage status are as follows:

1. Calculate the relative frequency (%) of each soil damage parameter.
2. Provides a score value for each parameter based on relative frequency values with a range from 0 to 4 (Table 7).
3. Add up the score values for each parameter of the soil damage criteria.
4. Determination of land damage status based on the sum of the score values (8 and 9).

Assessment of Land Damage Status Using Frequency Method on Several Land Use for Biomass Production in Payakumbuh City

Table 8. Soil Damage Score Based on Relative Frequency

No	Relative Frequency of Damaged Soil (%)	Score	Land Damage Status
2	11 – 25	1	Light Damage
3	26 – 50	2	Moderately Damaged
4	51 – 75	3	Heavy Damaged
5	76 – 100	4	Very Heavy Damaged

Table 9. Soil Damage Status Based on Accumulated Soil Damage Score Values for Dry Land

No	Symbol	Land Damage Status	Accumulated Soil Damage Score Value
1	N	Not broken	0
2	R.I	Light Damage	1 – 14
3	R. II	Moderately Damaged	15 – 24
4	R. III	Heavy Damaged	25 – 34
5	R. IV	Very Heavy Damaged	35 – 40

RESULTS AND DISCUSSION

The results of land identification and verification show that the land in the five sub-districts of Payakumbuh City in the research area has a Light Damage Status (RI) covering an area of 2391.65 ha and Moderate Damage (RII) covering an area of 1856.76 ha. From 10 observation sample points, the soil in the study area has two levels of soil damage; namely moderate damage and light damage. Soil damage is caused by limiting factors. In moderate damage status, the limiting factors are (RII-vpre), namely soil porosity, degree of water escape, redox reactions and electrical conductivity. Meanwhile, in soil with mild damage status, the limiting factors are (RI-vre), namely soil porosity, redox reactions and electrical conductivity (Suryadi et al., 2020); (Nursita, 2020) hilly land typology. (Land degradation, 2023); (Hudson & Alcántara-Ayala, 2006) The results of the study show that the limiting factors that influence the level of soil degradation for biomass development in the study area are as follows: (Nursita, 2020), ; (Suryadi et al., 2020)

Based on a combination of soil damage factors such as soil type, slopeslope, rainfall and land management systems in five sub-districts of Payakumbuh City have an impact on land damage. This can be seen from the results of studies, observation results and soil analysis results in the laboratory which show that there are several parameters that exceed the critical threshold for soil damage. The parameters that exceed the critical threshold for soil damage are porosity, degree of water permeability, redox potential and electrical conductivity at several observation locations..

Parameters of porosity, soil permeability or degree of water leakage are influenced by levelroomsoil pores and soil density. The degree of water release that is beyond the standard threshold for damage is land that has a value beyond the standard threshold. This shows that the degree of water discharge is low so that surface water runoff will increase which will increase erosion on upland land. However, it will be different from paddy fields, which require the land to be flooded. If the erosion is large, it will thin the treated layer, thereby affecting other soil properties such as pH value, redox and also the electrical conductivity of the soil.

Technology for improving porosity, permeability, redox and electrical conductivity can be carried out using an environmentally friendly land management system; namely by soil management accompanied by the addition of organic materials, harvest residues, other ameliorant materials such as agricultural lime such as dolomite. Organic material left over from the harvest needs to be chopped into fine pieces with a copper tool, so that the organic material decays quickly and releases nutrients into the soil which are absorbed in the plant tissue.

Redox (reduction-oxidation) is considered damaged because the value is less than the critical threshold, namely 200 mV. This is because most of the land studied has slopes that are flat and gentle. Use is dominated by rice fields and moorlands. When it rains on flat land, runoff water will easily saturate the soil pores, in this condition reduction will usually be more dominant than oxidation. Therefore the Eh value of redoxi is lower. This low Eh value usually occurs in rice fields. This is because paddy soil has a low redox value. (Nursita, 2020); (Shehrawat & Singh, 2003) Reclamation of moderately or lightly damaged land can be done by improving the land management system such as; conservation tillage, also return plant residues to the soil and avoid burning crop residues.

Assessment of Land Damage Status Using Frequency Method on Several Land Use for Biomass Production in Payakumbuh City

Table 10. Recapitulation of Land Damage Status Evaluation

Land Units	Solum thickness	Surface rockiness	Composition of colloidal fractions	Content weight B.V	Total porosity	Degree of water flow	pH (H 2O 1:2.5)	Power Send Electric/DH L	Red ox	Number of microbes	Total Score	Land Use	Status Soil Damage	Symbol
KPY S1	0	0	0	0	4	4	0	4	4	0	16	ricefield	Moderately Damaged	RII-vpre
KPY S2	0	0	0	0	4	4	0	4	4	0	16	moor	Moderately Damaged	RII-vpre
KPY T1	0	0	0	0	4	4	0	4	4	0	16	moor	Moderately Damaged	RII-vpre
KPY T2	0	0	0	0	4	0	0	4	4	0	12	ricefield	Light Damage	RI-vpre
KPY U1	0	0	0	0	0	4	0	4	4	0	12	ricefield	Light Damage	RI-pre
KPY U2	0	0	0	0	4	0	0	4	4	0	12	moor	Light Damage	RII-vre
KPY LT1	0	0	0	0	4	0	0	4	4	0	12	ricefield	Light Damage	RI-vre
KPY LT2	0	0	0	0	4	4	0	4	4	0	16	moor	Moderately Damaged	RI-vpre
KPY B1	0	0	0	0	4	0	0	4	4	0	12	ricefield	Light Damage	RI-vre
KPY B2	0	0	0	0	4	0	0	4	4	0	12	moor	Light Damage	RI-vre

Assessment of Land Damage Status Using Frequency Method on Several Land Use for Biomass Production in Payakumbuh City

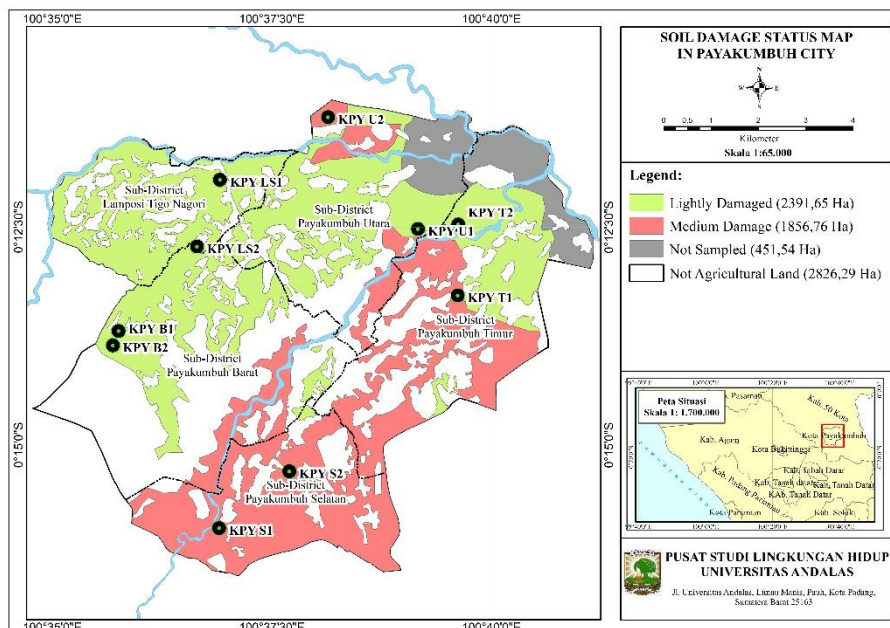

Figure 2. Map of land damage status

CONCLUSION

1. Based on the results of land identification and verification, it shows that the land in the five sub-districts of Payakumbuh City which is included in this study area has a slightly damaged (RI) status covering an area of 2391.65 ha and moderately damaged (II) covering an area of 1856.76 ha.
2. Soil damage in the five sub-districts of Payakumbuh City which are included in the study area all have land damage status of Lightly Damaged (RI) with limiting factors of porosity, redox and DHL, and Moderately Damaged (II) with limiting factors of porosity, degree of water flow, redox and DHL.

REFERENCES

- 1) Aprisal, Istijono, B., Mimin, H., Juniarti. 2018. Soil quality index analysis under horticultural farming in Sumani Upper Watershed. *International Journal of Geomate*, April 2019, Vol.16, Issue 56, pp. 191 - 196 ISSN: 2186-2982 (P), 2186-2990 (O), Japan.
- 2) SoilDegradation. <https://www.sciencedirect.com/topics/earth-and-planetary-sciences/soil-degradation>. (2023, January 1).
- 3) I. Virto, M. Imaz, O. Fernández-Ugalde, N. Gartzia-Bengoetxea, A. Enrique, and P. Bescansa, "Soil Degradation and Soil Quality in Western Europe: Current Situation and Future Perspectives," *Sustainability*, vol. 7, no. 1, pp. 313–365, 2014, doi: 10.3390/su7010313.
- 4) B. Aghasi, A. Jalalian, and N. Honarjoo, "The comparison of some soil quality indices in different land uses of Ghareh Aghaj Watershed of Semirrom, Isfahan, Iran," *World Acad. Sci. Eng. Technol.*, vol. 71, no. 11, pp. 167–171, 2010, [Online]. Available: <http://www.scopus.com/inward/record.url?eid=2-s2.0-78651552119&partnerID=40&md5=a96513203da26f1161af3aad1cf1cec2>.
- 5) DS Aspects and SS Properties, "Influence of Different Slope Aspects on Some Soil Properties and Forest Soils Evolution (Case Study: Rostam Abad Region, Guilan Province)," pp. 1–8, 2022.
- 6) (2022, April 5). Climate change, agriculture and food security. <https://www.greenfacts.org/en/climate-agriculture-food-security/index.htm>
- 7) Basak, N., Mandal, B., Kumar, A., & Basak, P. (2021, March 1). Soil quality and productivity improvement: Indian story. <https://doi.org/10.1007/s43538-021-00007-8>
- 8) Bekele, T. (2019, May 13). Effect of Land Use and Land Cover Changes on Soil Erosion in Ethiopia. <https://doi.org/10.17352/2455-815x.000038>
- 9) Environmental Sustainability. (2023, January 1). <https://www.sciencedirect.com/topics/agricultural-and-biological-sciences/environmental-sustainability>

Assessment of Land Damage Status Using Frequency Method on Several Land Use for Biomass Production in Payakumbuh City

- 10) Kardol, P., Fanin, N., & Wardle, D A. (2018, May 1). Long-term effects of species loss on community properties across contrasting ecosystems. <https://doi.org/10.1038/s41586-018-0138-7>
- 11) Agustina, C., Rayes, M L., & Rosidha, E. (2020, July 1). Soil Quality Mapping on Rice Fields in Turen District, Malang Regency. *Brawijaya University*, 7(2), 367-373. <https://Doi.Org/10.21776/Ub.Jtsl.2020.007.2.22>
- 12) Hudson, P F., & Alcántara-Ayala, I. (2006, February 1). Ancient and modern perspectives on land degradation. <https://doi.org/10.1016/j.catena.2005.11.003>
- 13) Land degradation. (2023, January 17). https://en.wiktionary.org/wiki/land_degradation
- 14) Nursita, D. (2020, December 30). Soil quality index analysis in efforts to overcome land degradation in Nganjuk Regency., 15(2), 96-106. <https://doi.org/10.29122/jstmb.v15i2.4564>
- 15) Shehrawat, P S., & Singh, S. (2003, January 1). Management of Dryland Sustainable Agriculture. <https://econpapers.repec.org/RePEc:ags:ifma03:24308>
- 16) Suryadi, S., Dharmawan, A H., & Barus, B. (2020, August 31). Palm Oil Plantation Expansion: Social, Economic and Environmental Issues (Case Study of Pelalawan District, Riau). *Diponegoro University*, 18(2), 367-374. <https://doi.org/10.14710/jil.18.2.367-374>



There is an Open Access article, distributed under the term of the Creative Commons Attribution – Non Commercial 4.0 International (CC BY-NC 4.0) (<https://creativecommons.org/licenses/by-nc/4.0/>), which permits remixing, adapting and building upon the work for non-commercial use, provided the original work is properly cited.

Theory of Self-Serve Skills Education for 3-4 Years Kindergarten Children in Daily Living Regime



Nguyen Thi Hong¹, VO Nguyen Doan Trinh², Le Thi Hong Xuan³

^{1,2,3}Thu Dau Mot University

ABSTRACT: In daily activities, teachers and parents need to create an environment that encourages children to practice and try. Guiding children to perform these tasks not only helps them feel satisfied when completing tasks, but also forms good habits and develops social skills, such as sharing and collaborating with friends. Furthermore, these self-service experiences also contribute to building a solid foundation for future development, helping children become confident and independent individuals in life. However, this activity has been done in preschool age, especially in preschool age of 3-4 years old, but the effectiveness in children is not high. Therefore, it is necessary to have educational measures to form and develop to help children perfect self-service skills, essential for children to be more independent, confident, and proactive in their personal activities.

KEYWORDS: Education, skills, self-service, preschoolers, daily living regime

1. INTRODUCTION

During the development stage from 3 to 4 years old, educating preschoolers on self-service skills plays an important role in forming independence and confidence. At this age, children are able to acquire and practice basic skills such as feeding themselves, dressing themselves and maintaining personal hygiene. Guiding children to perform these tasks not only helps them develop independence but also form good habits and responsibility for themselves. Besides, educating self-service skills also helps children improve their confidence in communicating and interacting with friends. Through daily activities, in preschool, children have the opportunity to practice and practice necessary social skills. This not only lays the foundation for personal development but also prepares children to participate in later learning and social environments. Therefore, applying self-service skills education in the daily routine of children in preschool is very necessary, contributing to nurturing good qualities and comprehensive development of children.

2. RESEARCH CONTENT

2.1. Some tool concepts

a. Education concept

There are many concepts about education: like authors Vo Van Nam and Nguyen Thi Tuyet Hong: "Education is an activity aimed at training and fostering human personality. This activity cannot be carried out arbitrarily according to subjective wishes or individual experiences but must be based on scientific guidelines. (Nguyen Thi Bich Hong & Vu Van Nam, 2004). Or according to author Tran Thi Tuyet Oanh: "Education is understood as a unified process of mental and physical formation of each individual in society. That means education plays an inseparable role in human and social life. It is a social phenomenon." (Tran Thi Tuyet Oanh, 2006). We can generalize that education is a process of teaching and learning, forming each individual in all aspects such as: personality, behavior, habits, concepts and ideals of life, and inherent life skills. people,... Aims to help each individual realize the correct values of life and solve problems in social life.

b. Skills concept

Skill is the use of someone's ability or ability to perform an action to create a desired result. According to the Vietnamese dictionary, skill is the ability to apply acquired knowledge into practice. [1.p372]. According to Associate Professor, Dr. Nguyen Thi My Loc, skill is the ability to manipulate and perform a certain activity. [8.p80] According to wikipedia, skill is a person's ability to apply knowledge to perform a technical professional task, solve organizational, management and

Theory of Self-Serve Skills Education for 3-4 Years Kindergarten Children in Daily Living Regime

communication problems... [12] In my opinion, skill means an effective way of doing things. To have skills or in other words to be able to do work effectively requires that person to have knowledge and know how to apply it to work.

c. Self-service concept

According to the Vietnamese dictionary, service means doing one's part to directly help someone or something [1.p 569]. Also according to the Vietnamese dictionary, self is a word used to refer to one's own strength and abilities [1.p760]. According to tratu.soha.vn, self-service is doing things for your daily living needs yourself, without needing help or service.[13] Through the above concept, in my opinion, self-service means working on your own to serve your own needs without needing outside help.

d. Concept of self-service skills

Self-service skills are understood as self-service skills and getting used to children's daily activities in behavior and communication with people around them.[3] Through the above concept, in my opinion, self-service skills are children's daily living habits in communication and behavior towards themselves and those around them. Practicing life skills and self-service skills for children, gradually forming a child's personality is one of the key tasks that need to be given top priority.

e. Concept of daily living regime

Living regime is a reasonable allocation of time and activities during the day for children to meet their psychological and physiological needs, thereby helping children form attitudes to life, routines and habits. and positive life skills.

2.2. Basic issues in educating self-service skills for 3-4 year old preschoolers in daily living

2.2.1. The goal is to educate self-service skills for 3-4 year old preschoolers in daily activities at preschool.

The current situation is that preschool children lack knowledge of basic skills, the most basic of which is self-service skills. Most children live very selfish lives, only knowing about themselves, only knowing how to receive, knowing how to enjoy but not knowing how to give. At school as well as at home, children almost completely lack initiative, always rely on the care and protection of relatives, all of their activities depend mostly on adults, whenever they encounter a situation. Difficult situations in reality are confusing and don't know how to handle them.[7]

Mục tiêu ngay từ độ tuổi 3-4 tuổi về việc giáo dục kỹ năng tự phục vụ là chăm sóc về dinh dưỡng, sức khỏe và thể chất. Đối với trẻ 3-4 tuổi việc xây dựng những thói quen sinh hoạt tốt cho trẻ là điều hết sức cần thiết để giúp trẻ luôn khỏe mạnh và giàu năng lượng. Ba mẹ nên hướng dẫn cho con biết cách sinh hoạt tích cực như rửa tay bằng xà phòng trước khi ăn và sau khi đi vệ sinh, ăn nhiều rau xanh, trái cây, uống đầy đủ nước, giữ ấm cơ thể khi trời lạnh, không xem tivi quá gần, chỉ đọc sách trong môi trường có đủ ánh sáng...[4] The goal from the age of 3-4 years old on self-service skills education is to take care of nutrition, health and physical fitness. For children 3-4 years old, building good living habits for them is extremely necessary to help them stay healthy and energetic. Parents should teach their children how to practice positive activities such as washing hands with soap before eating and after going to the toilet, eating lots of green vegetables and fruits, drinking enough water, keeping the body warm when it's cold, Don't watch TV too close, only read books in a well-lit environment...[4]

2.2.2. Stages of developing self-service skills for 3-4 year old preschoolers in daily activities at preschool.

Developing self-service skills is carried out through stages:

- Stage 1: Understanding how to do: In this stage, what skills do children know how to do? In what order do the skills occur?

How to perform each skill? [7]

Developing self-service skills is carried out through stages:

- Stage 1: Understanding how to do: In this stage, what skills do children know how to do? In what order do the skills occur?

How to perform each skill? [7]

- Stage 2: Forming self-service skills: Children know how to apply knowledge in a certain self-service activity. However, carrying out each type of action

Developing self-service skills requires children to pay attention, make efforts and strive.[7]

- Stage 3: Applying self-service skills: Turning volitional actions into automatic actions, by practicing daily.[7]

2.2.3. Daily routine of 3-4 year old children

Authors Sheryl, Deborah Stewart, ... have built a children's daily routine that includes different activities from the time they arrive at school to the time they leave, including: children moving to music, playing physical games, Next, children work in play corners according to their personal interests and needs. They carry out their own review, testing, and experience activities with new content to prepare for the next day's activities.

G. A. Soltseva has designed the content of each activity in the daily routine for 3-4 year old children and is very interested in designing the content of each activity towards the purpose of educating self-help skills. service for children. For example, the time

Theory of Self-Serve Skills Education for 3-4 Years Kindergarten Children in Daily Living Regime

to pick up children (receive children, check body temperature, chat with children's parents, teach children to undress themselves, fold clothes, put clothes and lockers, put on gym uniforms themselves). , choose your own game....)

Authors Nguyen Thi Hoa, Nguyen Thanh Huyen,... pointed out the content of children's daily routine including activities: Picking up children, learning activities, outdoor activities, playing activities, eating , sleeping, afternoon activities, returning children.[2]

In the preschool education program issued by the Ministry of Education and Training (2009), the daily living regime of preschool children includes the following activities: Picking up children, playing, morning exercise, studying, and activities in kindergartens. corner, play outdoors, eat meals, sleep, eat snacks, play, do activities as desired, prepare to leave and return children [1]. With many different approaches, studies have clearly shown that the daily routine of 3-4 year old children includes age-appropriate activities in a day from the time the child goes to school until the time the child leaves home. . On the other hand, at each age there will be an appropriate time distribution for each activity. Accordingly, the daily routine of 3-4 year old children includes activities with appropriate timing as follows: [1]

STT	Work	Time
1	Pick up children, do morning exercise, take attendance	80-90 minutes
2	Learning activities	15-20 minutes
3	Outdoor activities	15-20 minutes
4	Play activities	25-30 minutes
5	Having lunch	60-70 minutes
6	Nap	150 minutes
7	Eat a snack	20-30 minutes
8	Afternoon activities	70-80 minutes
9	Return the child	60-70 minutes

The daily routine of 3-4 year old children is different from other ages in terms of time for each activity and the teacher's role in organizing activities. Children 3-4 years old are in the stage of physiological and psychological development but are not yet complete, their ability to withstand external influences is still limited, and their attention span is not yet stable. Therefore, the time spent on activities for children is also different from other ages.

For example: children sleep more than 4-5 year olds, 3-4 year olds study less (15-20 minutes) than 4-5 year olds (20-25 minutes), play time is less (15-20 minutes). of children is less...[1]

2.2.4. Daily living regime and self-service skills education for 3-4 year old children.

Self-service skills are qualities in a child's psychology. Educating children on self-service skills is to help them become confident, active, and independent people in life, creating for them a solid personality foundation, contributing to realizing the goals of preschool education. [3]. From there we can understand:

Educating self-service skills for 3-4 year old preschoolers through the daily routine of preschool is a process of interaction between educators and children through the organization of activities in the preschool regime. daily activities to best educate children on self-service skills.

Through activities in the daily routine of preschool children, children can come up with their own activity ideas and choose their own activity content. For example, through play, teachers create opportunities for children to come up with their own ideas about the game, choose the play angle, play content, and play roles, through which children can assert themselves. This is an opportunity that adults give children, helping them boldly and confidently express all their needs, interests and abilities, from which adults can grasp them to have appropriate impacts, helping children develop. Promote children's self-service skills in activities.[5]

Theory of Self-Serve Skills Education for 3-4 Years Kindergarten Children in Daily Living Regime

Through the game, she creates a situation where there is a shortage of toys, so children have to think for themselves to find replacements to fulfill the content of the game. Or, through the teacher assigning tasks to children such as cleaning utensils, taking charge of the classroom, arranging toys in the classroom... children will have to find their own ways and means to solve situations. situations during the implementation process to complete her tasks herself.[3]

Thus, it can be affirmed that daily living regime plays a very important role in the process of educating self-service skills for preschool children. Teachers need to organize activities in their daily routine regularly and continuously, giving children the opportunity to practice, strengthen and develop self-service skills for 3-4 year old preschoolers. in daily routine at preschool.

2.2.5. The development of self-service skills for 3-4 year old preschool children in daily activities at preschool.

When still at preschool age, children do not yet have the necessary skills to serve themselves in their daily activities at preschool, and everything they do requires support from teachers. dressing, scooping rice, putting on shoes, folding blankets and pillows, getting food, etc. Therefore, when children are 3-4 years old in kindergarten, teachers need to form the necessary skills for them. Let children serve themselves in their daily routine at preschool young. From there, children can serve themselves starting from the simplest and smallest tasks without needing the teacher's support, and this also helps teachers have more time to do tasks. other in class.[8] The development of self-service skills is proportional to the child's development. The older they get, the more sustainable, clear and positive the development of self-service skills becomes. At the age of 3-4 years old, children's independence develops strongly, they want to work like adults, they want to do it themselves without needing help from adults.

However, 3-4 year old children are not aware of the difference between their subjective wishes and their real abilities. Therefore, children's operations and actions are still clumsy, lacking precision and dexterity. Children do not yet understand why they act this way or that way, so their perseverance and effort are not high. During activities, children may give up and not complete the work. However, there are fundamental changes in children's behavior, moving from spontaneous behavior to social behavior. Although this move is only the beginning, it is a good basis for the next stage.[7]

Although young preschoolers develop self-service skills in certain daily activities, these manifestations are random and require direction to develop. development. At the same time, these manifestations contribute to affirming that self-service skills education in children's daily routine must start from preschool age.[7]

2.2.6. Content of self-service skills education for 3-4 year old preschoolers in daily activities at preschool

Self-service is a full-time job. Putting off this "work" can harm your confidence, relationships, and joy in life. Self-service is an important part of living a happier and healthier life, as well as helping you become more connected to the community in which you live. [3] Children who know how to serve themselves have characteristics such as: putting on their own shoes, washing hands after going to the toilet, cleaning up toys after playing, etc. Children who know how to serve themselves have the following symptoms: serving themselves such as getting food during lunch, folding blankets after waking up, brushing their teeth after finishing lunch,... knowing how to maintain personal hygiene. take care of body parts. Maintaining personal hygiene and taking care of body parts are basic life skills that preschool children need to protect themselves, repel the risk of hand, foot and mouth disease, respiratory infections... and independent in life.

Therefore, from an early age, parents need to tell their children the importance of these tasks and teach them how to perform personal hygiene activities such as washing hands before eating and after using the toilet. comb your hair, brush your teeth regularly, feed yourself, wear clothes properly, put shoes in the right place, put trash in the right place, don't watch TV too close, read books in a place with adequate light... know how to manage Handling and cleaning personal belongings.

In order for children to have neat and tidy skills, adults need to teach children how to use toys, clothes, pens, books and notebooks... effectively and reasonably. Children will know how to put toys, clothes, pens, and books in the right place if their parents guide them and set an example.[3]

2.2.7. Some factors affecting the education of self-service skills for 3-4 year old preschoolers in daily activities at kindergarten

2.2.7.1. Genetic factors affect the education of self-service skills for 3-4 year old preschoolers in daily activities at kindergarten

Family side: some parents pamper their children too much and always do everything for them without teaching them, letting them do it themselves. Or some children lose their parents at a young age, so they lack love and guidance, so they don't know how to serve themselves.[2]

- Most parents are not fully aware of the importance of training children's self-service skills; Can't control yourself to guide your child to the right place when the child is slow to learn or refuses to concentrate when given instructions but lets the child figure it out on their own or does it for them.[2]

2.2.7.2. Factors of body development that affect the education of self-service skills for 3-4 year old preschoolers in their daily routine at preschool

Genes and environment affect child development. Genes are the blueprint for development, containing regulatory information about your child's appearance, behavior, physical and mental health and more.

Theory of Self-Serve Skills Education for 3-4 Years Kindergarten Children in Daily Living Regime

The information in a child's genes comes from the parents themselves. The environment is a child's experiences from home, school and community. The environment affects language, independence, and how children cope to overcome difficult times or build relationships.[8] As children develop, genes and environment influence each other. The way genes and environment work together affects a child's development.

For example, how a child responds to a stressful situation depends on his or her mood (mostly determined by genes) and the relationships he or she builds with other individuals in his or her environment (usually family).

Children are born ready to learn, and their brains develop through use. Therefore, children need a stimulating environment with many diverse activities, helping them have fun and learn while also having many opportunities to practice what they have learned.[8]

Other factors such as nutrition, physical activity, health and living area also have a great impact on a child's health and development.

2.2.7.3. Educational factors affecting the education of self-service skills for 3-4 year old preschoolers in daily activities at kindergarten

Many parents do not teach their children properly or always neglect their children, causing them to not know how to serve themselves. Always protecting your children too much makes them not want to serve themselves but always rely on adults, creating the habit of relying on others. Gradually, children will not have the skills to serve themselves without adults.[7] Self-training has a very broad category, but in this study we only discuss four basic areas of life: physical, intellectual, emotional and social training.[7] Practice serving yourself first by:[3]

+ Train children to eat, rest, and exercise fully and on time.[3]

+ Teach children to balance their time between studying, playing, between family and friends... From then on, children always strive to renew themselves by constantly learning good and new things.[3]

+ If you want to be healthy and beautiful, you must exercise. If you want to be healthy and beautiful, you must exercise. Talk about the importance of self-training, including physical training and sports.[3]

+ Health training is training the body with three qualities: endurance, flexibility and strength. Endurance comes from exercise, increasing cardiovascular efficiency; Flexibility is achieved through stretching exercises; Strength is gained through muscle endurance training.[3]

+ Children always like to listen and follow what they see and hear. Therefore, regularly jog with your children, take them to the park, practice driving, and play physical games with them to help them understand the benefits of physical exercise and participate in a fun way. The main thing is to motivate children to practice themselves[3]

+ In addition to training children in sports skills, it also trains children in morality, helping them to be polite and obedient. [7] Training children from a young age in the above skills is to build a ladder for their future success. Parents should be the first to say thank you to their children and grandparents, regularly take their children to visit their grandparents and ancestors, and stimulate their children's love and pride in their roots and nation. Regularly take children to bookstores and choose suitable books for them, and participate in children's book festivals; Take children to visit historical relics... and effective educational ways for children to train themselves.[7]

3. CONCLUSION

Educating self-service skills for 3-4 year old preschoolers in their daily routine is an important task, contributing to forming a solid foundation for the child's comprehensive development. Skills such as feeding oneself, dressing oneself and maintaining hygiene not only help children become independent but also foster self-confidence and a sense of responsibility. Through practicing these skills, children not only practice self-service abilities but also develop necessary social skills, such as sharing and collaborating with friends. Creating an environment that encourages children to practice and try is essential, helping children feel proud of their abilities. Furthermore, self-service skills education also helps children build good habits, thereby forming positive personality and life values. Therefore, focusing on self-service skills education not only benefits children's personal development but also creates responsible and independent citizens in the future.

REFERENCES

- 1) Ministry of Education and Training (2009). Preschool education program (Issued with Circular No. 17/2009/TT-BGDĐT dated July 25, 2009 of the Minister of Education and Training).
https://moet.gov.vn/content/vanban/Lists/VBDH/Attachments/2147/01_VBHN-BGD%C4%90T.PDF
- 2) Nguyen Thi Hoa (2009). Preschool education curriculum. University of Education Publishing House.
- 3) Mai Ngoc Lien (1972). Self-service skills education for preschool children. University of Culture Publishing House.

Theory of Self-Serve Skills Education for 3-4 Years Kindergarten Children in Daily Living Regime

- 4) Nguyen Thi Phong (1983). Research work on Educational Theory. Hanoi Publishing House.
- 5) Nguyen Thi Thu (ed) (1980). Skills education for children. Dong Nai Publishing House.
- 6) Tran Thi Trong (1983). System of skill questions for preschool children. Education Publishing House.
- 7) Nguyen Anh Tuyet (2007). Psychology of preschool children. University of Education Publishing House.
- 8) Nguyen Thi My Loc, Dinh Thi Kim Thoa & Thi Thao Huong (2012). Teaching life values and life skills to preschool children (Documents for preschool teachers). Hanoi National University Publishing House.
- 9) Crupkaia (1999), Inheritance, New York
- 10) Nguu Le, Ly Chinh Mai, Pham Thuy Anh, (2000), Methods of raising children (from 4 to 6 years old), Women's Publishing House.



There is an Open Access article, distributed under the term of the Creative Commons Attribution – Non Commercial 4.0 International (CC BY-NC 4.0) (<https://creativecommons.org/licenses/by-nc/4.0/>), which permits remixing, adapting and building upon the work for non-commercial use, provided the original work is properly cited.

Guided Inquiry Design (GID) as a Pedagogical Practice in Teaching Practical Research



Mustaham, Judith C.

Teacher III Baliwasan Senior High School-Stand Alone Department of Education, Division of Zamboanga City

ABSTRACT: This study determined the performance of grade 12 senior high school students in Practical Research using Guided Inquiry Design during the school year 2022-2023. The study utilized the quasi-experimental research design employing pretest and posttest in Practical Research 2 during the 4th quarter. The participants of this study were 55 Grade 12 students in HUMSS F for the experimental group and 51 students of in HUMSS G for the control group. Purposive sampling technique was utilized in determining the samples of the study. This study determined the performance of grade 12 senior high school students in Practical Research using Guided Inquiry Design during the school year 2022-2023. The study utilized the quasi-experimental research design employing pretest and posttest in Practical Research 2 during the 4th quarter. The participants of this study were 55 Grade 12 students in HUMSS F for the experimental group and 51 students of in HUMSS G for the control group. Purposive sampling technique was utilized in determining the samples of the study. This study concludes that the GID was effective in enhancing the students' learning outcomes based on the increase of the posttest result and mean difference between the pre-test and posttest. The finding implies that the students in the experimental group who were exposed to GID performed better than the control group with no exposure to GID. It is important to apply GID in class because it develops pedagogical practices that scaffold students' independent inquiry in learning. Since GID instruction is based on team teaching and inquiry circles, this greatly helps students collaborate with each other which is vital in producing a final output in Practical Research. The researcher will continue to apply GID in teaching to improve existing practices. The researcher recommends that the School Heads will encourage the teachers to use GID in teaching. Teachers can engage in team teaching and inquiry circles to ignite more the interest of the students. Other researchers can use the findings of this study as avenues for future research.

KEYWORDS: guided inquiry design; inquiry circle; team teaching, Practical Research

INTRODUCTION

Teacher's delivery of instruction in the classroom plays a significant role in making teaching-learning process effective. Teachers are empowered to carry out quality instruction by using varied instructional and formative assessment strategies for students' learning (DepEd Order 42, S. 2016,1). This study investigated the effectiveness of Guided Inquiry Design in the students' learning in Practical Research 2.

The research-based Guided Inquiry Design Framework offers a strong framework for inquiry-based learning. Students need time to familiarize themselves with a topic and freely explore it before they can form a focus (Kuhlthau et al., 2015,1).

The aim of Guided Inquiry Design is to make the students construct their own knowledge using the sources available to them (Alamettälä and Sormunen, 2018,5). Guided Inquiry Design, according to (Kuhlthau et al., 2012,4), helps in igniting the interest of the students to build background knowledge in formulating research questions.

In the study of (Juniar et al., 2020,1) the findings revealed that using Guided Inquiry Design in teaching improved the students' learning outcomes from pre-test 81.88 to 85.49 in posttest. Likewise, (Heath 2015,5) emphasized that it develops the skills and competence of the students in writing. Guided Inquiry Design improves the students' ability to synthesize and interpret information.

The Baliwasan Senior High School- Stand Alone is a pioneering, stand-alone, public secondary institution which operated on June 13, 2016. The school caters to students coming from major junior high schools (JHS) of the city and neighboring provinces. As a pioneering institution, the school envisions to produce well-equipped graduates who are competent in research writing.

Guided Inquiry Design (GID) as a Pedagogical Practice in Teaching Practical Research

However, students have poor performance in research writing. They could hardly express their ideas in writing sentences and paragraphs.

Apparently, if this insufficiency will not be addressed, the school will not be able to produce graduates who are efficient researchers and competitive enough to face the challenges of today's world. Hence, they need a strategy that will motivate them to improve their performance in writing research.

This present scenario at Baliwasan Senior High School-Stand Alone has inspired the researcher to conduct this action research in order to enhance the performance in Practical Research. The action research addresses the needs of the students for them to become better and more efficient researchers. It focuses on developing their skills through the use of instructional strategies. It is for this reason that the researcher embarked on this study to determine the effectiveness of the Guided Inquiry Design applied in Practical Research.

The study focused on the effectiveness of Guided Inquiry Design in teaching Practical Research for Grade 12 learners of Baliwasan Senior High School-Stand Alone, Baliwasan District, SY 2022-2023. The teacher used Guided Inquiry Design in teaching Practical Research before the post-test. The pre-test and posttest in Practical Research were given to Grade 12 learners. The study can initiate the Policymakers to support the teachers in utilizing strategies such as the GID so that the students will have the motivation and eagerness to venture into research writing. This support can be particularly useful to Research teachers considering the fact that the subject is passive in nature. With the Guided Inquiry Design, students will be inspired to write and discover new knowledge.

Innovation, Intervention And Strategy

This study utilized **Guided Inquiry Design** as the intervention. According to (Kuhlthau et al., 2012,4), Guided Inquiry Design is based on the idea that an invited teacher in class who possesses the expertise of the topic makes the students more motivated. Using team teaching and inquiry circles make the students collaborate with others.

Guided Inquiry Design involves team teaching and inquiry circle. **Team teaching** is conducted with the presence of an invited teacher, an expert in the field of research, who teaches on specific topics in Practical Research as the need arises. It also engages students in collaboration, which help them work together and converse on specific topic and tasks. According to (Bennett & Fisch, 2013,1), having two teachers fully engaged and active in the learning environment is effective.

Inquiry circle is a weekly activity where all members of the group meet together to work on the different tasks in the research process. Each group has a leader and assistant leader who leads in accomplishing the tasks given by the teacher. The purpose of team teaching and inquiry circle in practical research is to enhance students' leadership skills and encourage them to contribute to the development of their research project. At the end of the semester, they are expected to defend their research project before a panel.

Guided Inquiry Design is important because it develops pedagogical practices that scaffold students' independent inquiry in learning Practical Research concepts. This teaching strategy is expected to improve the performance level of Grade 12 students in Practical Research by allowing them to learn independently at their own pace after scaffolding is done by the teacher.

There may be a lot of circumstances that create difficulty for students to improve their performance in research, such as lack of interest in the subject, having difficulty to write, and probably, parents' support at home. All of these things may lead to one factor: the strategy to use in the classroom. With this notion, the topics of this research made a great impact in providing the researcher with a greater understanding of the processes involved in establishing an environment that would enhance students' performance using the Guided Inquiry Design.

Baliwasan Senior High School-Stand Alone is one of the stand-alone schools in Zamboanga City Division. It is expected that the school performs well in Practical Research. However, students are found passive in writing. It is therefore recommended that research must be conducted among the target respondents of the study.

The Guided Inquiry Design was conducted in Practical Research 2 class of Humanities and Social Sciences 12 section F to see the effectiveness in the experimental group.

1. After giving the pre-test to both groups, the control group had the traditional lesson discussion during the Practical Research 2 period and the experimental group used Guided Inquiry Design.
2. Team teaching was applied weekly for one month. An invited Guests who possessed expertise in research and statistical treatment trained the students on how to tabulate the data using Microsoft excel, present the data using tabular and graphical forms, process and analyze the quantitative data using the SPSS, draw conclusion and formulate recommendations.

Guided Inquiry Design (GID) as a Pedagogical Practice in Teaching Practical Research

3. Inquiry Circle was then applied in class weekly, where all members of the group met together to work on the different stages in the research process. Each group had a leader and assistant leader who led in accomplishing the tasks given by the teacher.
4. Activities were given to the students every meeting. Written activities were recorded and documented for one month.
5. After the intervention, a posttest was administered to both the experimental and control groups.

Action Research Questions

This study aimed to determine the effectiveness of Guided Inquiry Design in teaching Practical Research for Grade 12 learners at Baliwasan Senior High School-Stand Alone.

Specifically, this study sought to answer the following problems:

1. What is the mean score of the experimental and control groups in Practical Research 2 before the conduct of the Guided Inquiry Design?
2. What is the mean score of the experimental and control groups in Practical Research 2 after the conduct of the Guided Inquiry Design?
3. What is the mean difference of the experimental and control groups in Practical Research after the conduct of Guided Inquiry Design?
4. Is there a significant difference in the mean difference of the experimental and control groups in Practical Research before and after the conduct of Guided Inquiry Design?

METHODOLOGY

Research Design

In this study, the researcher utilized the quasi-experimental research design employing pre-test and posttest in Practical Research during the 4th quarter. This is quantitative research to determine the performance of grade 12 senior high school students using Guided Inquiry Design in teaching Practical Research.

Quasi-experimental designs identify a comparison group that is as similar as possible to the treatment group in terms of baseline (pre-intervention) characteristics (White and Sabarwal 2014, 4).

Participants and/ or other sources of Data and Information

The respondents of this study were the 55 Grade 12 students in HUMSS F and 51 Grade 12 students in HUMSS G who were enrolled in Practical Research during the second semester of school year 2022-2023. The respondents were chosen based on the following criteria: least in pre-test results compared with other sections handled by the researcher; poor academic performance in midterm; and poor performance in writing research. The researcher utilized the purposive sampling technique in determining the study samples, hence, the intervention was intended purposely for 12 HUMSS F.

Research Instrument

The instrument in this study was a researcher-made test which was composed of 35 items in multiple-choice test and 5 points in essay in Practical Research 2. The essay focused on the discussion of the data in a given table. It was rated using an analytic rubric which includes: substance and mechanics in writing-5 points. The instrument was pilot tested to the non-respondents for item analysis. It was subjected to an item analysis test to test its reliability and validity. Twenty-five copies of the instruments were administered to the non-respondents with similar characteristics with the respondents. The data were then inputted and analyzed using the Norm-Reference-Item Analysis. The result showed that the reliability was .892, which implies that the instrument was accepted and reliable. The result indicates that most of the items were accepted based on the Index of Discrimination and level of difficulty and the decision was "retained," hence the instrument was ready for data gathering.

Data Gathering Procedure

Data gathering was conducted after the approval of the research proposal. First, the researcher secured approval from the Schools Division Superintendent through a letter to gather data from the Grade 12 students of Baliwasan Senior High School-Stand Alone. The researcher presented the permission letter to the District Supervisor and school principal. Having the permission granted, the researcher administered the pre-test to all sections handled by the researcher. The researcher chose HUMSS 12 G and HUMSS 12 F to be part of the study since these sections obtained the least scores. The researcher oriented the students in HUMSS 12 F on the purpose of this educational experiment using the Guided Inquiry Design and gave the Consent for their approval of the inclusion in the study. Next, the researcher performed routine activities by using a Guided Inquiry Design. Team teaching and inquiry circles were conducted weekly for one month. This served as the treatment. Then, posttest materials were administered to both the experimental and control groups. Lastly, the researcher did the tabulation, analysis and interpretation of data.

Guided Inquiry Design (GID) as a Pedagogical Practice in Teaching Practical Research

Data Analysis

The researcher utilized Mean to determine the mean scores and the mean difference before and after the conduct of Guided Inquiry Design (GID) in Practical Research to the experimental and control groups. Moreover, Paired-Samples T-test was used to determine the significant difference in the pre-test and posttest of the experimental and control groups.

RESULTS AND DISCUSSION

Students' performance before the intervention. Table 1 presents the mean scores of the students in Practical Research 2 of the control and experimental group before the intervention.

Table 1. Mean scores of the experimental and control groups in Practical Research 2 before the Conduct of the Guided Inquiry Design.

Experimental Group				Control Group			
Mean Score	SD	Equivalent Grade	Description	Mean Score	SD	Equivalent Grade	Description
20.39	3.25	75	Fairly Satisfactory	11.79	2.26	71	Did not meet expectation

Legend:

90-100 = Outstanding 85-89 = Very satisfactory 80-84 = Satisfactory
 75-79 = Fairly Satisfactory Below 75 = Did not meet expectations
 (DepEd Memo No. 042, s. 2020)

As shown in table 1, the mean score of the Experimental Group is 20.39, which is described as *Fairly Satisfactory*, while the Control Group has a mean score of 11.79, which is described as *Did not meet expectation*. The standard deviation of 3.25 of the experimental group implies that the scores are extreme and far from the mean while in the control group, the standard deviation is 2.26 which implies that the scores are close and lie within the mean. Looking at the data closely, the Experimental Group got a higher mean than the Control Group. This means that the students in both experimental and control groups have to learn and master the competencies in Practical Research. Being a critical skill as well as a potential tool for learning (Arnold et al., 2017), writing is not an easy task, according to Galbraith and Baaijen (2018,1).

Students' performance after the intervention. Table 2 presents the mean scores of the students in Practical Research 2 of the control and experimental group after the intervention.

Table 2. Mean scores of the experimental and control groups in Practical Research 2 after the Conduct of the Guided Inquiry Design.

Experimental Group				Control Group			
Mean Score	SD	Equivalent Grade	Description	Mean Score	SD	Equivalent Grade	Description
25.13	2.05	86	Very Satisfactory	13.25	3.08	72	Did not meet expectation

Legend:

90-100 = Outstanding 85-89 = Very satisfactory 80-84 = Satisfactory
 75-79 = Fairly Satisfactory Below 75 = Did not meet expectations
 (DepEd Memo No. 042, s. 2020)

As shown in table 2, the mean score of the Experimental Group is 25.13, which is described as *Very Satisfactory*, while the Control Group has a mean score of 13.25, which is described as *Did not meet expectation*. The standard deviation of 2.05 of the experimental group implies that the scores are narrowed and close to the mean while in the control group, the scores are extreme and scattered, hence the scores are far from the mean. Looking at the data closely, the Experimental Group got a higher mean than the Control Group.

The study's findings confirm (Kayaalp et al., 2022, 1) that students in the experimental group outperformed those in the control group in terms of academic achievement and self-regulation abilities.

Guided Inquiry Design (GID) as a Pedagogical Practice in Teaching Practical Research

Mean difference of the control and experimental groups in the pretest and posttest. Table 3 presents the mean difference of the students in practical research 2 after the conduct of GID.

Table 3. Mean difference of the control and experimental groups in Practical Research 2 after the conduct of Guided Inquiry Design

	Experimental Group Mean Score	Control Group Mean Score
Pretest	20.39	11.79
Posttest	25.13	13.25
Mean Gain score	4.74	1.46

Legend:

90-100 = Outstanding 85-89 = Very satisfactory 80-84 = Satisfactory
 75-79 = Fairly Satisfactory Below 75 = Did not meet expectations
 (DepEd Memo No. 042, s. 2020)

As shown in Table 3, the mean difference of the senior high school students in Practical Research 2 is 4.74 for the Experimental group, while for the Control group, the mean difference is 1.46. The finding implies that the students in the experimental group performed better than those in the control group since the Experimental group was exposed to the Guided Inquiry Design.

The study confirms (Juniar et al., 2020,1) that student's learning outcomes which taught by applying the guided inquiry (GI) model increased from pre-test 81.88 to 85.49 in post-test with average N-gain approximately 20%.

Testing the difference in the mean scores of the experimental and control groups. Table 4 shows the result of Paired – Samples T-test on the significant difference in the mean scores of senior high school students in Practical Research 2 before and after the conduct of Guided Inquiry Design.

Table 4. Significant difference in the mean scores of the experimental and control groups in Practical Research 2 before and after the conduct of Guided Inquiry Design

Respondents	Experimental	Control	t-value	P-value	Interpretation
Pretest	20.39	11.79	19.974	.000	Significant
Posttest	25.13	13.25	23.353	.000	Significant

*Significant at @=0.05

Table 4 shows the result of Paired-Sample T-test on significant difference in the mean scores of the experimental and control groups in Practical Research 2 before and after the conduct of Guided Inquiry Design. It is evident that the t-value of the pre-test was 19.974, and the posttest had the t-value = 23.353 with p-values < 0.05, indicated that a significant difference existed. This means that there is a significant difference in the mean scores of the two groups.

This implies that both groups improved their performance in Practical Research 2 by obtaining an increase in the posttest result. It is also evident that students from the experimental group obtained a higher mean score compared to the control group because the experimental group was exposed to the Guided Inquiry Design.

The study backs up Heinström and Sormunen's (2018,1) conclusion that GID's strengths are in structuring the inquiry process, eliciting students' interest, guiding students' progress through the process, and scaffolding the process using tools.

CONCLUSION AND RECOMMENDATIONS

This study concludes that the Guided Inquiry Design was effective in enhancing the students learning outcomes based on the increase of the posttest result and mean difference between the pre-test and posttest. The finding implies that the students in the experimental group who were exposed to the Guided Inquiry Design performed better than those in the control group who did not have an exposure to GID. There was a significant difference in the mean scores of the experimental and control groups in Practical Research 2 before and after the conduct of GID. Guided Inquiry Design is important because it develops pedagogical practices that scaffold students' independent inquiry in learning. Since GID instruction is based on team teaching and inquiry

Guided Inquiry Design (GID) as a Pedagogical Practice in Teaching Practical Research

circles, this greatly helps students collaborate and converse with each other. This will enhance the students' collaboration, which is vital in producing or creating a final output. The researcher will continue to apply GID in teaching to improve existing practices.

Based on the results, the researcher recommends that the School Heads will encourage the senior high school teachers to use the Guided Inquiry Design in teaching Practical Research and other subjects. Teachers can invite other teachers with expertise in specific topics to teach the lessons in class to ignite more the interest of the students. Inquiry circles can be applied in teaching to promote engagement and collaboration among students. Other researchers can use the findings of this study as avenues for future research.

Action Plan

Objectives	Strategies/ Activities	Time Frame	Persons involved	Resources Needed	Expected Outcomes
Program/ Project : Administration of Pretest & Posttest					
To administer Pre-test & Posttest in the third quarter	Administering the Pre-test & Posttest in 3rd quarter	Second Semester of Every School Year	<ul style="list-style-type: none"> • Subject Group Head • Students 	Printed copies of the Modules, Lesson Plan, Handouts, Pre-test and Posttest	Students equipped with life-learning skills.
Utilization of Guided Inquiry Design in teaching Practical Research for grade 12 students					
To utilize Inquiry Design in teaching Practical Research	Implementation of Guided Inquiry Design in Practical Research weekly	2 nd Semester of every School Year	Subject Group Head Students	Printed copies of the Modules, Lesson Plan, Handouts	Students improved their performance in Practical Research
Team teaching in Practical Research and Inquiry Circle					
To invite an expert in the field of research to speak in Practical Research class and to apply Inquiry Circles	Inviting an expert in the field of research to speak in Practical Research class and engaging the students in Inquiry Circles	Second Semester of Every School Year	Subject Group Head Teachers Students	Printed copies of the Modules, Lesson Plan, Handouts	Students performed better in Practical Research

ACKNOWLEDGMENT

The researcher heartily thanks and acknowledges the assistance and expertise of the following people who helped made this study a success:

Dr. Majarani M. Jacinto, CESO V, Schools Division Superintendent, for the approval to conduct the study;

Dr. Victoria D. Mangaser, Chief Education Program Supervisor-Curriculum Implementation Division, for her encouragement and moral support;

Dr. Valeriafides G. Corteza, Education Program Supervisor for English, for her never-ending support and encouragement in the conduct of this study;

Dr. Elga Z. Jarlega, Public School District Supervisor, Baliwasan District, for her encouragement, inspiration and guidance in the conduct of this study;

Guided Inquiry Design (GID) as a Pedagogical Practice in Teaching Practical Research

Ms. Janekin V. Hamoc, Education Program Specialist for Research, for her never-ending support, inspiration and encouragement in the conduct of this study;

Mr. Felix C. Mabanag Jr., Principal I of Baliwasan Senior High School, for the support and consideration in allowing the researcher to conduct the data gathering from the students;

Dr. Deborah E. Bandahala, Statistician and Research Evaluator of Baliwasan District, for helping the researcher in the analysis of data and for her constructive criticism and supportive suggestions in the refinement of this research;

The **Students** from Baliwasan Senior High School-Stand Alone as the respondents of this study, for spending their precious time in answering the instrument and for participating the implementation of the Guided Inquiry Design;

Above all, to God the Almighty, for the divine intervention, strength, and wisdom.

REFERENCES

- 1) Alamettälä, Tuulikki and Sormunen Eero. 2018. "Lower secondary school teachers' experiences of developing inquiry-based approaches in information literacy instruction." Retrieved from: <https://core.ac.uk/download/pdf/250152801.pdf>
- 2) Alharbi, Fahad. 2015. "Writing for learning to improve students' comprehension at the college level". *English Language Teaching*, 8(5), 222–234. doi:10.5539/elt.v8n5p222
- 3) Arnold, Kathleen M., Sharda Umanath, Kara Thio, Walter B. Reilly, Mark McDaniel and Elizabeth J. Marsh. 2017. "Understanding the cognitive process involved in writing to learn". *Journal of Experimental Psychology: Applied*, 23(2), 115-127. doi:10.1037/xap0000119
- 4) Bennett, Deborah J. and Fisch, Audrey A. 2013. "Infusing coteaching into the general education field experience". *Interdisciplinary Journal of Teaching and Learning*, 3(1), 18–37.
- 5) DO 42, s. 2016. Policy Guidelines on Daily Lesson Preparation for the K to 12 Basic Education Program.
- 6) Galbraith, David and Veerle M. Baaijen. 2018. "The work of writing: Raiding the inarticulate. *Educational Psychologist*" 53(4), 238-257 doi:10.1080/00461520.2018.1505515
- 7) Grassian, Esther, Diane Mizrachi and Lorienne Roy. 2017. *Information literacy in the workplace*. ECIL 2017 (pp. 683 -692). Cham, Switzerland: Springer (Communications in Computer and Information Science, 810).
- 8) Heath, Rosemarie Antonniette. 2015. "Toward learner-centered high school curriculum-based research: A case study". *Journal of Librarianship and Information Science*, 47(4), 368 – 379
- 9) Heinström, Jannica and Eero Sormunen. 2018. "Structure to the unstructured - Guided Inquiry Design as a pedagogical practice for teaching inquiry and information literacy skills". Proceedings of ISIC: The Information Behaviour Conference, Krakow, Poland, 9-11. vol. 24 no. 1.
- 10) Juniar, Anna, Silalahi, Albinus, Suyanti, Retno Dwi. 2020. "The Effect of Guided Inquiry Model on Improving Students' Learning Outcomes and Science Process Skills in Qualitative Analytical Chemistry Practicum," *Universal Journal of Educational Research*, Vol. 8, No. 11, pp. 5457 - 5462, 2020. DOI: 10.13189/ujer.2020.081149.
- 11) Kayaalp, Fatih , Elif Meral, and Zeynep Başçı Namlı, 2022. "An analysis of the effect of writing-to-learn activities regarding students' academic achievement and self-regulation skills in writing". *Participatory Educational Research (PER)* Vol.9(1), pp. 324-348, January 2022 Available online at <http://www.perjournal.com>
- 12) Kuhlthau, Carol C., Leslie K. Maniotes and Ann K. Caspari. 2012. *Guided Inquiry Design: a framework for inquiry in your school*. Santa Barbara, CA: Libraries Unlimited.
- 13) Price, Paul C., Rajiv Jhangiani, I-Chant A. Chiang, Dana C. Leighton, and Carrie Cuttler. 2017. *Research Methods in Psychology: One-Group Designs*. <https://opentext.wsu.edu/carriecuttler/chapter/8-1-one-group-designs/>
- 14) White, Howard and Shagun Sabarwal. 2014. *Quasi experimental design and Methods*. Impact Evaluation 8



There is an Open Access article, distributed under the term of the Creative Commons Attribution – Non Commercial 4.0 International (CC BY-NC 4.0)

(<https://creativecommons.org/licenses/by-nc/4.0/>), which permits remixing, adapting and building upon the work for non-commercial use, provided the original work is properly cited.

Coping Mechanisms of Mathematics Teachers in a Modular Distance Learning in the Selected Secondary Schools in the Division of Ilocos Sur



Annaliza Q. Elizarde

College of Graduate Studies, Ilocos Sur Polytechnic State College, Sta. Maria, Ilocos Sur, Philippines

ABSTRACT: The purpose of this study was to find out the problems faced and how Mathematics teachers managed to teach their subject in selected secondary schools in Ilocos Sur during the school year 2020-2021. The key areas in that were explored included: difficulty encountered and ways of handling that; the positive well-being; time management; change readiness; peer coaching; and teamwork. The study sought to establish co-relations between various challenges, coping strategies, and teacher performance under modular distance learning paradigm and, therefore, the research design adopted was descriptive-correlational. Questionnaire was of two parts and was administered to 31 Mathematics teachers and the regularity was compared using weighted mean and correlation analysis. Results highlighted that despite these difficulties in modular distance learning teachers overwhelmed and improvised through time management the principles of change management, the use of technology, team work and peer coaching. Several indicators also pointed to teacher effectiveness; this based on their circumstance reports containing IPCRF ratings. Only time management and peer mentoring were found to have relation with the teacher's performance while the employees considering the challenges did not affect performance. A recommended intervention, therefore, includes training and development of teachers, and facilitating counselling services, interprofessional collaboration, and teacher enabled schools. Professional standards suggest that teachers should carry on changing, technological, and professional learning with peers in order to maintain high levels of performance and effectively answer to the difficulties occurred in the context of distance learning.

KEYWORDS: challenges, coping mechanisms, modular distance learning

I. INTRODUCTION

The COVID-19 outbreak was declared a public health emergency of international concern by the World Health Organization (WHO) in early 2020, disrupting the lives and, consequently, work and education processes in various countries. The literature indicates that those challenges were not only physical or financial but psychological and emotional since fear and uncertainty increase with the virus spread (World Health Organization, 2020). Lockdown of businesses, lay off, economic recessions, travel bans, and closure of schools disrupted education systems across the Globe. At the moment, due to COVID-closures, over 1.5 billion learners have been out of school, thus turning education facilities into entities that had to quickly switch to other forms of delivery.

In the Philippines the education system changes dramatically as the move from the traditional face-to-face delivery to multiple modalities of remote learning in order to continue education as the pandemic spread (Cahapay, 2020). The Department of Education (DepEd) came up with the Basic Learning Continuity Plan (BLEP) focusing on the competencies for basic learning, multiple learning delivery methods, and health and safety standards (DepEd, 2020). Modular Distance Learning or (MDL) was identified as the mode adopted most with region adopting distance learning mostly when Internet connection is poor. This self-learning approach offered the students standardized mode of learning to use at their own pace (Llego, 2020).

Nevertheless, a transition to modular distance learning proved problematic for educators, particularly mathematics teachers and trickled down the problem of preparing, delivering, and evaluating the modular content, as well as providing timely support in delivering complex lessons. Research indicates that Mathematics as a subject that entails critical thinking skills was hampered in the pandemic by a lack of direct contact between students and teachers (Magsambol, 2020). In addition, challenges cited by

Coping Mechanisms of Mathematics Teachers in a Modular Distance Learning in the Selected Secondary Schools in the Division of Ilocos Sur

educators include lack of print media, connectivity problems, and delays in submitted work by the students (Baticulon et al., 2021).

Because these challenges are significant, this study basically sought to establish the following research questions: The specific challenges encountered by secondary-level Mathematics teachers as they implement modular distance learning and the coping strategies used while implementing modular distance learning. The current literature has highlighted the need for coping and working conditions, team collaboration, psychological counseling and training, so as not to compromise the negative impact of the pandemic on learning (García and Weiss, 2020; Kim and Asbury, 2020). The findings of this research will be useful in planning subsequent interventions to bolster teachers' coping ability and performance in a changing education environment.

II. RESEARCH METHODOLOGY

Research Design

The researcher used the descriptive-correlational research design which provided answers to what's and how's of the current research. It also explained the coping mechanism of the participating Mathematics teachers and their level of performance during the pandemic. The correlational research design as cited by Pantaleon (2022), sheds light on the relationships between the challenges of the respondents and their coping mechanisms.

Population and Locale of the Study

The Mathematics Teachers in the selected Secondary Schools in the Division of Ilocos Sur, SY 2020 – 2021 gave meaning to the research through their responses. The distribution of respondents is presented below.

Table 1. Distribution of Respondents

School	Population	Percentage (%)
Santa Maria National High School	12	38.71
Ag-agrao National High School	2	6.451
San Esteban National High School	5	16.129
Burgos National High School	7	22.58
Santiago National High School	5	16.129
Total	31	100.00

Using total enumeration, a total of 31 mathematics teachers were involved in the study as respondents.

Research Instrument

The research instrument was divided into two parts. Part I contains the data on the challenges met by the teachers in modular distance learning while Part II is a set of checklists of coping mechanisms. The questionnaire was adopted from the study of Makabenta (2021). An interview guide was used in the gathering data on the coping mechanisms of teachers qualitatively. Document analysis was also used to gather data on the performance of teachers based on their latest IPCRF.

Data Gathering Procedure

The researcher secured permission from the Office of the Schools Division Superintendent of the Schools Division of Ilocos Sur and the school principal of the selected Secondary Schools in the Division of Ilocos Sur before gathering data. A survey questionnaire that includes challenges, a checklist on coping mechanisms was distributed, retrieved, tallied, analyzed and interpreted.

Statistical Treatment of Data

To treat and analyze the data gathered, the following statistical tools were used:

Weighted Mean was used to determine the extent of challenges and coping mechanisms of teachers during the pandemic. It also determined the level of the performance of the teachers as indicated in their IPCRF during the School Year 2020-2021.

Spearman rho was utilized to measure the degree of relationships between the challenges of the respondents and their coping mechanisms, challenges and performance of the respondents, and the coping mechanism and the performance of teachers, respectively.

Coping Mechanisms of Mathematics Teachers in a Modular Distance Learning in the Selected Secondary Schools in the Division of Ilocos Sur

Data Categorization

The researcher used the following scales to interpret the gathered data:

A. Challenges and Coping Mechanisms of Teachers

Scale	Range	Descriptive Rating	Overall Rating
5	4.21 – 5.00	Strongly Agree (SA)	Very High (VH)
4	3.41 – 4.20	Agree (A)	High (H)
3	2.61 – 3.40	Moderately Agree (MA)	Moderate (M)
2	1.81 – 2.60	Slightly Agree (SA)	Slight (S)
1	1.00 – 1.80	Disagree (D)	Low (L)

B. Individual Performance Commitment and Review Form Rating of Mathematics Teachers

Range	Descriptive Rating
4.500 – 5.000	Outstanding (O)
3.500 – 4.499	Very Satisfactory (VS)
2.500 – 3.499	Satisfactory (S)
1.500 – 2.499	Unsatisfactory (U)
below 1.499	Poor (P)

III. RESULTS AND DISCUSSIONS

The table shows the challenges met by teachers in the implementation of modular distance learning.

Table 2. Challenges Met by Teachers in the Implementation of Modular Distance Learning

Indicators	Mean	DR
1. Unstable internet connectivity	3.35	A
2. Lack of materials and equipment for the reproduction of learning resources.	3.16	MA
3. Unable to deliver the lesson to the pupils in a face-to-face classroom.	3.90	A
4. Unsure of the lessons conveyed are mastered by the pupils.	3.97	A
5. Increase the number of non-readers and non-numerates in the class.	3.77	A
6. Enhancing the skills of the learners.	3.71	A
7. Parents support the learning of the pupils.	3.45	A
8. There are certain parents who lack the desire and ability to teach their children the substance of the lessons.	3.61	A
9. Some parents never provide guidance and assistance to their children's studies.	3.68	A
10. Low marginal status of the family.	3.35	MA
11. Teachers are affected by this DepEd intervention.	3.48	A
12. Some of the time is used in the implementation of the DepEd program.	3.55	A
13. Teachers continue to work overtime only to comply with all of these.	3.74	A
14. Lack of training to craft video lessons.	3.74	A
15. Teachers are still under stress in the execution of their roles and obligations.	3.52	A
Overall Challenges Met	3.60	H

Overall, the results reflected a mean score of 3.60 interpreted as high which yielded the same outcome in the study of Makabenta (2021). On the other hand, Solis (2021) posited that the respondents got an overall mean score of 4.91 interpreted as very high. The results imply that the respondents agreed that they have experienced challenges during the implementation of modular distance learning. Therefore, teachers must be provided with the necessary knowledge, attitude and skills in the preparation and implementation of MDL. With the provision of technical assistance, teachers are expected to perform their jobs and responsibilities effectively even in the midst of the pandemic.

Coping Mechanisms of Mathematics Teachers in a Modular Distance Learning in the Selected Secondary Schools in the Division of Ilocos Sur

The results, in particular, reflected that item number 4 which is “*Unsure of the lessons conveyed is mastered by the pupils*” got the highest mean score of 3.97 with a descriptive rating of agree. The result suggests that the respondents are uncertain whether the learners achieved mastery of the most essential learning competencies provided the limitations of using the modular distance learning. Teachers had difficulty validating their actual performance as Anzaldo (2021) claimed that not all learners do their modules committedly and without the presence of teachers and classmates who remind them of their work.

Furthermore, the results also indicate that item number 2 “*Lack of materials and equipment for the reproduction of learning resources*” got the lowest mean score of 3.16 with a descriptive rating of moderately agree. This denotes that they are provided with materials and equipment in the production of self-learning modules and assessment tools such as printers, ink, bond papers and staplers. On the study of Gueta and Janer (2021), they also mentioned the same challenges. According to them, teachers lack resources for reproduction and delivery of modules. Sometimes they don’t have time printing the modules due to time constraint, malfunctioned printers and unavailability of printing materials such as bond papers and ink.

However, in the study conducted by Hernandez (2021) “*Lack of focus due to work-related and home-related activities at home*” garnered the highest frequency and rank among the enumerated challenges by the teacher-respondents. This result only shows variations of impact of modular distance learning on teachers.

Table 3. Coping Mechanism of Teachers Along Positive Well-Being

INDICATORS	Mean	DR
1.Boosting self-confidence by encouraging others.	4.23	SA
2.I take vitamins for my health to reduce stress	3.39	A
3.When I feel tired, I also take a rest for a moment and pray for God’s strength.	4.52	SA
4.The only thing I have in mind now is positivity	4.42	SA
5.I still believe that above all of these things we are experiencing right now, there will always be ways to reduce the learners holistically.	4.39	SA
Overall Positive Well-Being	4.19	H

On coping mechanisms along positive well-being, item number 3 “*When I feel tired, I also take a rest for a moment and pray for God’s strength*” got the highest mean score of 4.52 described as strongly agree which deviates from the study of Makabenta (2020). The results signify that the respondents gain positive well-being from God and find peace in the midst of difficult circumstances brought by the changes in the modality of learning. However, they don’t usually take vitamins to reduce stress as reflected in the result with the lowest mean score of 3.99 described as agree conforming to the finding of Makabenta (2020).

De Villa and Manalo (2020) cited that encouraging outlook, self-confidence gained from encouragement and motivation, healthy lifestyle, and stress reduction allows them to continue performing their duties and responsibilities despite the challenges of these trying times

Table 4. Coping Mechanism of Teachers Along Time Management

INDICATORS	Mean	DR
1.Even there are a lot of things to do, I still do my best to accomplish those things on time.	4.52	SA
2.I give more than enough time to work with the learning materials even late at night.	4.10	A
3.I believe that time management is very important to accomplish the tasks.	4.74	SA
4.I make my on-time line in accomplishing the tasks given me	4.06	A
5.I work on the task given me and submit or accomplish it on time	4.45	SA
Overall Time Management	4.37	VH

Coping Mechanisms of Mathematics Teachers in a Modular Distance Learning in the Selected Secondary Schools in the Division of Ilocos Sur

Along time management, most of the respondents picked the indicator *“I believe that time management is very important to accomplish the tasks”* with a mean score of 4.74 termed as strongly agree. The outcome implies that the respondents value time and its relevance in the accomplishment of their various tasks. On the other hand, indicator *“I make my own timeline in accomplishing the tasks given me”* got the lowest mean score of 4.06 interpreted as agree which denotes that the respondents merely make or organize timeline. Both results conform to the study of Makabenta (2020) concluding that time management helps them accomplish things on time which allows them to attend to school duties and household chores. De Villa and Manalo (2020) further adds that establishing routines through habits and practices in a set schedule help them to utilize time efficiently.

Table 5. Coping Mechanism of Teachers Along Openness to Change

INDICATORS	Mean	DR
1.It's a good thing that I'm very open to new learnings and I'm very interested in the new techniques as to the technology tools and online resources are involved.	4.61	SA
2.We, teachers, are very adaptive to the changing teaching-learning process because we are said to engage in never-ending learning.	4.65	SA
3.Every day we learn new things and these things are helpful for us to cope with the challenges of the new normal.	4.55	SA
4.I am resilient to change.	4.45	SA
5.I tried my best to learn new things from peers and superior to effectively implement the new normal way of education	4.58	SA
Overall Openness to Change	4.57	VH

On openness to change, all indicators got a descriptive rating of strongly agree; however, the second indicator which is *“We, teachers, are very adaptive to the changing teaching-learning process because we are said to engage in never-ending learning”* got the highest mean score of 4.65 while the fourth indicator *“I am resilient to change”* got the lowest mean score of 4.45. The results signify that the respondents are open for changes that come along with the shifting of learning modality. The same results yielded in the study of Makabenta (2020) stating that flexibility and adaptability are important qualities that every teacher must acquire De villa and Manalo (2020) which allows them to survive and still succeed.

Table 6. Coping Mechanism of Teachers Along Peer Mentoring

INDICATORS	Mean	DR
1. Seeking help from my co-teachers since we are dealing with the same pressure in making good outputs is important	4.32	SA
2.I ask help from my colleagues in studying different computer applications and gathering online resources and references to make my teaching easier.	4.00	A
3.I ask assistance from those who are experts in using technology so I will be more acquainted in integrating it into my lessons.	3.97	A
4.I value the support given me by my colleagues	4.45	SA
5.I apply the technical assistance given to me by my mentor.	4.39	SA
Overall Peer Mentoring	4.23	VH

As presented in the table, majority of the respondents picked item number 4 *“I value the support given me by my colleagues”* with a mean rating of 4.45 described as strongly agree while indicator 3 *“I ask assistance from those who are experts in using technology so I will be more acquainted in integrating it into my lessons”* got the least mean score of 3.97. This implies that mentoring is magnified in the workplace between and among the respondents. They help one another by providing technical assistance in the accomplishment of different tasks. De Villa and Manalo (2020) Mentoring provides a strong support system in holistic well-being and development of educators. As teachers embrace change, peer mentoring allows them to build confidence and nurture competence in the new normal.

Coping Mechanisms of Mathematics Teachers in a Modular Distance Learning in the Selected Secondary Schools in the Division of Ilocos Sur

On the other hand, in a similar study conducted by Makabenta (2020), item 4 also got the highest mean score along items 3 and 4; however, the result negates the item with the lowest mean score. This implies differences of the respondents' perception or practice of seeking guidance and support from one another.

Table 7: Coping Mechanism of Teachers Along Collaboration

INDICATORS	Mean	DR
1.We ask assistance from the stakeholders in the proper implementation of distance learning modality.	4.16	A
2.We seek help from external stakeholders for the other things we need that our schools cannot provide.	4.13	A
3.I seek help and support from the parents of my pupils in assisting and guiding their children learning at home.	4.13	A
Overall Collaboration	4.14	H

Along collaboration, the table reveals that item number 1 *"We ask assistance from the stakeholders in the proper implementation of distance learning modality"* got the highest mean score of 4.16 described as Agree while the second and the third indicators *"We seek help from external stakeholders for the other things we need that our schools cannot provide"* and *"I seek help and support from the parents of my pupils in assisting and guiding their children learning at home"* got the least mean score of 4.13 also deduced as agree. This indicates that the respondents maintain strong partnership with stakeholders during the implementation of modular distance learning.

On one hand, the results negate the findings of Makabenta (2022) having item 3 as the indicator with the highest mean score while item 5 with the lowest mean score. This shows that the respondents have different ways of collaborating with stakeholders.

This means that due to limited resources, the gaps are filled through the continuous support of stakeholders through community engagement and partnership. This implies that everyone in the school system is involved in designing learning opportunities to attain quality education despite of this pandemic.

Table 8. Summary on the Coping Mechanisms of Teachers

INDICATORS	Mean	DR
Positive Well-Being	4.19	High
Time Management	4.37	Very High
Openness to Change	4.57	Very High
Peer Mentoring	4.23	Very High
Collaboration	4.14	High
Overall Coping Mechanisms	4.30	Very High

Overall, openness to change obtained the highest mean score of 4.57 described as strongly agree while collaboration obtained the least mean score of 4.14 interpreted as agree. The results negate the study of Makabenta (2021) where collaboration garnered the highest mean score opposite to positive well-being. The results entail that the respondents had expressed various coping mechanism in dealing with the challenges during the implementation of modular distance learning. Some might have perceived that embracing changes could help them ease the challenges encountered during the implementation of modular distance learning while some embraced collaboration (Makabenta 2020) where everyone in the school system is involved in designing learning opportunities to attain quality education despite of this pandemic.

Coping Mechanisms of Mathematics Teachers in a Modular Distance Learning in the Selected Secondary Schools in the Division of Ilocos Sur

Table 9. Performance of Teachers (IPCRF)

Range	Frequency	Percentage	Adjectival Rating
3.500 – 4.499	14	45.16%	Outstanding
2.500 – 3.499	17	54.84%	Very Satisfactory
Total	31	100%	

As reflected in the table, 17 or 54.84% of the respondents obtained the rating equivalent to 3.500 to 4.499 with a descriptive rating of VS. Followed by 14 or 45.16% of the respondents obtained the rating equivalent to 4.500-5.00 with a descriptive rating of outstanding.

Overall the final average rating of the respondents is 4.40 described as very satisfactory. The same result was reflected in the study of Jomoad et al (2021). This implies that most of the respondents employ more than their expected and acceptable performance in the delivery of their duties and responsibilities as Mathematics teachers. The overall performance of teachers (Baluyos and Baluyos, 2019) indicated that the teachers were able to carry their job very satisfactorily in the teaching-learning process, in initiating activities that promote parents and community members' participation, and in updating themselves through attending seminars, workshops, and conferences.

Coping Mechanisms of Mathematics Teachers

The Covid-19 pandemic brought immense challenges in the implementation of the new learning modality. The following interview revealed the coping mechanisms expressed by the selected secondary teachers in the Division of Ilocos Sur.

The data from the transcript was analyzed using the Collaizi's Method of Data Analysis. The results of the analysis resulted to five themes.

Theme 1: Embracing change

Change is inevitable. Therefore, it requires people particularly educators to prepare themselves with changes in various aspects. Having such outlook allows them to embrace and engage in different tasks with ease and flexibility. Flexibility and adaptability are important qualities that every teacher must acquire (De Villa and Manalo, 2020). One participant stressed that being flexible helps them make the necessary adjustments in fulfilling their jobs even in the midst of difficult circumstances. As verbalized:

"So, the first thing to do, the first thing I did in order to cope is being openness to change. So, I am very open to new learning in which I'm very interested then, whatever changes, I'm very adapted to that change and I followed all the instructions with openness, all the suggestions or all the implementing guidelines in doing or implementing the distance learning." (Participant 1).

Another participant said that: *"I think we must always think positive and be ready for the different challenges that will come that will arise. So, for us teachers we must always flexible and open for changes just to meet the need of our learners since our priority in the DepEd is how we cater our learners especially and of course for the challenges during pandemic". (Participant 4).*

Theme 2: Time Management

According to De Villa and Manalo (2020), time management is an important practice to meet the demands of home and work. Time is essential for it affects the quality and efficiency of one's work. When time is consumed wisely, more and better things are done. With time management, plans are carried out smoothly which prevents haste and waste. One of the participants shared that they usually prepare a plan.

As verbalized:

"Since we are loaded with paper works and other auxiliary services, I always make a plan which serves as my guide in accomplishing those tasks" (Participant1).

Another one said: "I prepare a list to do things and I make sure that everything is properly executed." (Participant 5).

Coping Mechanisms of Mathematics Teachers in a Modular Distance Learning in the Selected Secondary Schools in the Division of Ilocos Sur

Theme 3: Digital Learning

The use of technology such as PowerPoint and videos provides both teachers and learners better learning opportunities. It serves as a teaching aid in the delivery of the teaching and learning process. One of the participants also stressed that using various social media platforms such as messenger, facebook and google forms help them reconnect with their learners. As verbalized:

“So, to cope up with all these challenges, kailangan mo siyang i-one on one. Talagang may interaction sa mga students thru messenger o kaya I call them to provide assistance sa pagsagot nila ng kanilang module.” (Participant 5)

Another participant said:

“No ania ti topic mi agaramidak ti video na, kasla koma ivideok diay bagbagik nga agsolve then i-explain ko no kasano.” (Participant 4).

Theme 4: Collaboration

The participation of external stakeholders filled the gaps (De Villa and Manalo, 2020) during the pandemic, thus partnership with stakeholders is encouraged. Having healthy partnership with the community contributes in the success of the implementation of school activities or programs. One of the participants mentioned the challenges in the delivery of materials; however, it became a bit lighter through the help of the external stakeholders.

As verbalized:

“The delivery of materials to learners is very hard. So, what we did is to ask help from the barangay officials and also parents in the distribution of the modules.” (Participant 4).

Theme 5: Monitoring

Keeping a track on learners’ progress during the pandemic is challenging. Communication is almost impossible; however, its importance is tantamount to the success of the learner in understanding the lessons. A participant shared that regular monitoring can help them in their academic journey.

As verbalized:

“I do some regular checking on the output of my students following them up if they were able to finish it on time and aside from that also I also some regular communications with my fellow teachers and friends who are teaching from other schools to ask about what they are doing, as part of benchmarking let’s say for example, just to be more excellent when it comes to deliver the lesson to them and lastly for the students to really know if they are learning a lot, I do some interventions, necessary interventions for those who hardly cope up with lessons and then that will be my basis if the students are already on track when it comes to the lessons being given to them.” (Participant 5)

Table 10 presents the relationship between the challenges met by the teachers and their level of coping mechanism.

Table 10: Relationship between Coping Mechanisms to Challenges Met by the Teachers

Indicators	rho	p-value	Interpretation
Positive Well-Being	0.342	0.059	Not Significant
Time Management	0.272	0.138	Not Significant
Openness to Change	0.336	0.065	Not Significant
Peer Mentoring	0.308	0.092	Not Significant
Collaboration	0.402*	0.025	Significant

The table presents that among the coping mechanisms, collaboration displays a significant relationship with the challenges encountered by the respondents during the implementation of modular distance learning with a positive correlation coefficient of 0.402 and p-value=0.025 values. This means that teachers who worked together, especially on a goal or shared projects have a greater capacity to manage internal and external stressful situations. This requires teachers to work together to address problems they encounter in teaching and other issues concerning students.

Coping Mechanisms of Mathematics Teachers in a Modular Distance Learning in the Selected Secondary Schools in the Division of Ilocos Sur

A variety of studies have shown that teachers benefit from collaboration. Connecting with other educators reduces stress because we are able to share problems and difficulties with people who can help find solutions. In fact, teachers who collaborate often report higher levels of job satisfaction, increased confidence in their abilities and a higher feeling of value (Barshay, 2014). Teacher collaboration also reduces the sense of isolation and can reduce the workload that teachers must shoulder by enabling them to compile common resources (Hanover Research, 2015). Gajendran and Brewer (2012) also claimed that collaboration is seen as an essential business trait in the construction industry for effective project delivery. In an organization, the solution of problems is based on the collective effort of the individuals who work together to attain it.

Other indicators such as positive well-being ($\rho=0.342$), time management ($\rho=0.272$), openness to change ($\rho=0.336$), and peer mentoring ($\rho=0.308$) show insignificant relationship to their performance.

Table 11 shows the relationship between challenges and performance of teachers.

Table 11. Relationship between Challenges and Performance of Teachers

Indicator	ρ	p-value	Interpretation
Challenges	-0.272	0.139	Not Significant

The table shows that there is an inverse relationship between challenges and performance of teachers. This is supported by the computed ρ of -0.272 with a p-value of 0.139. This indicates that teachers with lower level of challenges, or teachers with lesser issues, problems and concerns performed better. However, the result further shows that the relationship is insignificant. The researcher fails to reject the null hypothesis stating that there is no significant relationship between challenges and the performance of teachers.

Khan, Sha, Khan and Gul (2012) pointed out that the teacher's performance is negatively influenced by the different challenges contributing factors which either exists within or outside the educational institution, that impede the performance of teachers, resulting in lower individual as well as institutional productivity. The study further emphasized that educational institutions should focus on teachers' problems by understanding teachers' problems and also providing proper support to the teachers dealing with the problem. Yunarti, Asaloei, Wula, and Werang (2020) show parallel results showing a negative correlation between challenges and performance. However, it negates the findings showing that there is a significant relationship between these two variables. The study arrived at the conclusion that teachers of higher challenges performed lower.

Table 12 shows the relationship between coping mechanism and performance of the teachers.

Table 12. Relationship between Coping Mechanisms to Performance of Teachers

Indicators	ρ	p-value	Interpretation
Positive Well-Being	-0.281	0.126	Not Significant
Time Management	0.385	0.033	Significant
Openness to Change	-0.324	0.075	Not Significant
Peer Mentoring	0.434	0.015	Significant
Collaboration	0.015	0.935	Not Significant

It can be noted from the table that two of the indicators of coping mechanism show significant relationship to performance. This includes time management and peer mentoring which are directly related with the performance of the teachers.

Time manage is significantly related to performance of teachers with a computed ρ of 0.385 with a computed p-value of 0.033. This indicates that those teachers balance their time in the accomplishment of their various duties and responsibilities performed better.

Teacher time management is directly proportioned with the performance of students, teachers of public primary schools do plan actively and intelligently then they may be able in future to produce more intelligent minds for the future development of the nation. The significant relationship between teachers' time management and students' academic performance was found. The level of teachers' time management and academic performance was moderate, that's why it was recommended that teachers should improve their time management skills through consciousness about controlling their time

Coping Mechanisms of Mathematics Teachers in a Modular Distance Learning in the Selected Secondary Schools in the Division of Ilocos Sur

(Kayode, & Ayodele, 2015). In addition, effective utilization of teachers' time management (Ayodele & Oyewole, 2012) directly impacts teachers' performance (Ayodele & Ige, 2012; Achibong & Nja, 2011).

Peer mentoring also shows significant relationship to teachers' performance. This is supported by the computed $\rho = 0.434$ with $p\text{-value} = 0.015$. This means that peer mentoring is significantly related to teacher's performance. The researcher fails to research the null hypothesis that there is no significant relationship between coping mechanism along this indicator and teacher's performance. When teachers share knowledge, skills and abilities; they are expected to perform better.

Fletcher and Tienda (2009) showed that taking part in a course of study together with other teachers resulted in better performance than working in alone or in isolation. Lorenzetti et al. (2020) posit that peer mentorship promoted the development of work environments that emphasized community, collaboration, and shared purpose.

IV. CONCLUSIONS AND RECOMMENDATIONS

The following conclusions are drawn based on the salient findings of the study.

1. Teachers encounter challenges in the implementation of modular distance learning.
2. Teachers still manage to cope with the challenges brought by the implementation of modular distance learning.
3. Teachers performed very satisfactorily based on their latest IPCRF.
4. Teachers embrace changes, manage time, use digital technology, collaborate, and monitor students' progress to cope with the challenges met in modular distance learning.
5. Teachers used collaboration to cope with the challenges encountered in modular distance learning.
6. The challenges met by the teachers do not significantly influence the performance of teachers.
7. Time management and peer mentoring significantly affect the performance of teachers.

Based on the conclusions drawn, the following recommendations are forwarded.

1. Teachers shall be provided with training and faculty development programs to enhance their technical skills and pedagogies in teaching to hurdle the challenges brought about by the utilization of modular distance learning in mathematics.
2. The Department of Education may establish counseling programs for teachers to help them cope with the challenges brought about by the changes in the implementation of new modalities of teaching like modular learning.
3. The Department of Education and school principals should work with teachers at the pre-implementation of distance learning to address their needs in resources and training to effectively facilitate the delivery of quality education for students.
4. Teachers shall continue embracing changes, managing time, using digital technology, collaborating with peers, and monitoring students' progress to cope with the challenges met in modular distance learning.
5. Teachers shall nurture a culture of collaboration, cooperation, and teamwork in the performance of their functions and responsibilities to sustain impressive performance.
6. School heads shall create a sense of empowerment for teachers through training, involvement in decision-making, and develop a pleasant school environment.
7. Teachers shall form discussion groups and practice together where peer tutoring can be carried out to provide opportunities in overcoming the problems and challenges and to elevate teachers' performance.

REFERENCES

- 1) Archibong, I. A., & Nja, M. E. (2011). Towards Improved Teaching Effectiveness in Nigerian Public Universities: Instrument Design and Validation. *Higher Education Studies*, 1(2), 78-91. <http://dx.doi.org/10.5539/hes.v1n2p78>
- 2) Agayon, A. J. D., Agayon, A. K. R., & Pentang, J. (2022). Teachers in the new normal: Challenges and coping mechanisms in secondary schools. *Journal of Humanities and Education Development (JHED)*, 4.
- 3) Anzaldo, G. D. (2021). Modular distance learning in the new normal education amidst Covid-19. *International Journal of Scientific Advances*, 2(3), 263-266. <http://dx.doi.org/10.51542/ijscia.v2i3.6>
- 4) Ayodele, J. B., & Ige, M. A. (2012). Teachers' utilization as correlate of students' academic performance in senior secondary schools in Ondo State, Nigeria. *European Journal of Educational Studies*, 4(2), 282-287.
- 5) Bacabac, Maria Antonieta A. (2017). Predictors of Success of Mathematics Achievement of High Performing Junior High School Students. *American Journal of Educational Research*. Vol. 5, No. 8. Retrieved from <http://pubs.sciepub.com/education/5/8/2/index.html> on February 6, 2021.
- 6) Baluyos, G. R., Rivera, H. L., & Baluyos, E. L. (2019). Teachers' job satisfaction and work performance. *Open Journal of Social Sciences*, 7(08), 206.

Coping Mechanisms of Mathematics Teachers in a Modular Distance Learning in the Selected Secondary Schools in the Division of Ilocos Sur

- 7) Baloran, Erick T. (2020). Knowledge, Attitudes, Anxiety, and Coping Strategies of Students during COVID-19 Pandemic. *Journal of Loss and Trauma*. Retrieved from <https://doi.org/10.1080/15325024.2020.1769300> on February 4, 2020.
- 8) Cabardo, J. R. O., Cabardo, C. J. O., & Cabardo-Mabida, S. J. O. (2022). Challenges and mechanisms of teachers in the implementation of modular distance learning in the Philippines: a phenomenological study. *Sapienza: International Journal of Interdisciplinary Studies*, 3(1), 169-182.
- 9) Castroverde, F., & Acala, M. (2021). Modular distance learning modality: Challenges of teachers in teaching amid the Covid-19 pandemic. *International Journal of Research Studies in Education*, 10(8), 7-15.
- 10) De Villa, J. A., & Manalo, F. K. B. (2020). Secondary teachers' preparation, challenges, and coping mechanism in the pre-implementation of distance learning in the new normal. *IOER International Multidisciplinary Research Journal*, 2(3), 144-154.
- 11) Fletcher, J. M., & Tienda, M. (2009). High school classmates and college success. *Sociology of Education*, 82(4), 287-314. doi:10.1177/003804070908200401
- 12) Gajendran, T., & Brewer, G. (2012). Collaboration in public sector projects: unearthing the contextual challenges posed in project environments. *Engineering Project Organization Journal*, 2(3), 112-126.
- 13) Guiamalon, T. (2021). Teachers issues and concerns on the use of modular learning modality. *IJASOS-International E-Journal of Advances in Social Sciences*, 7(20), 457-469.
- 14) Jomuad, P. D., Antiquina, L. M. M., Cericos, E. U., Bacus, J. A., Vallejo, J. H., Dionio, B. B., ... & Clarin, A. S. (2021). Teachers' workload in relation to burnout and work performance. *International journal of educational policy research and review*.
- 15) Kayode, G. M., & Ayodele, J. B. (2015). Impacts of Teachers' Time Management on Secondary School Students' Academic Performance in Ekiti State, Nigeria. *International Journal of Secondary Education*, 3(1), 1-7. <http://dx.doi.org/10.11648/j.ijsedu.20150301.11>
- 16) Khan, A., Shah, I. M., Khan, S., & Gul, S. (2012). Teachers' stress, performance & resources. *International Review of Social Sciences and Humanities*, 2(2), 10-23.
- 17) Lorenzetti, D. L., Nowell, L., Jacobsen, M., Lorenzetti, L., Clancy, T., Freeman, G., & Oddone Paolucci, E. (2020). The role of peer mentors in promoting knowledge and skills development in graduate education. *Education Research International*, 2020.
- 18) Makabenta, Shiela B. (2021). Challenges Met and Coping Mechanism of Teachers in the Implementation of Distance Learning. Retrieved from
- 19) Nurunnabi, Mohammad. (2020). Coping Strategies of Students for Anxiety during the COVID-19 pandemic in China: A Cross-Sectional Study. Retrieved from <https://doi.org/10.12688/f1000research.25557.1> on February 6, 2021.
- 20) Peteros, Emerson et al. (2020). Factors Affecting Mathematics Performance of Junior High School Students. *International Electronic Journal of Mathematics Education*. Vol. 15, No.1. Retrieved from <https://doi.org/10.29333/iejme/5938> on February 5, 2021.
- 21) Pigaiani, Yolande. (2020). Adolescent Lifestyle Behaviors, Coping Strategies and Subjective Wellbeing during the COVID-19 Pandemic: An Online Student Survey. *Healthcare*. Retrieved from <https://doi:10.3390/healthcare8040472> on February 4, 2021.
- 22) Emad B. Algorani; Vikas Gupta. Coping Mechanisms Last Update: May 3, 2021. <https://www.ncbi.nlm.nih.gov/books/NBK559031/>
- 23) Yunarti, B. S., Asaloei, S. I., Wula, P., & Werang, B. R. (2020). Stress and performance of elementary school teachers of Southern Papua: A survey approach. *Universal Journal of Educational Research*, 8(3), 924-930.
- 24) Pantaleon, A. (2022). Development and Validation of Instructional Material in Basic Calculus. *International Journal of Innovative Science and Research Technology*, ISSN - 2456-2165, PP:- 228-232. [https://ijisrt.com/assets/upload/files/IJISRT22MAY490_\(1\).pdf](https://ijisrt.com/assets/upload/files/IJISRT22MAY490_(1).pdf)
- 25) Baticulon, R. E., Alberto, N. R., Baron, M. B., Mabulay, R. E., Rizada, L. G., Sy, J. J., & Tiu, C. J. (2021). Barriers to online learning in the time of COVID-19: A national survey of medical students in the Philippines. *Medical Science Educator*, 31(2), 615-626. <https://doi.org/10.1007/s40670-021-01231-z>
- 26) Cahapay, M. B. (2020). Rethinking education in the new normal post-COVID-19 era: A curriculum studies perspective. *Aquademia*, 4(2), ep20018. <https://doi.org/10.29333/aquademia/8315>
- 27) DepEd. (2020). Basic Learning Continuity Plan (BLEP). Department of Education. <https://www.deped.gov.ph/>

Coping Mechanisms of Mathematics Teachers in a Modular Distance Learning in the Selected Secondary Schools in the Division of Ilocos Sur

- 28) García, E., & Weiss, E. (2020). COVID-19 and student performance, equity, and U.S. education policy: Lessons from pre-pandemic research to inform relief, recovery, and rebuilding. Economic Policy Institute. <https://www.epi.org/publication/the-consequences-of-the-covid-19-pandemic-for-education-performance-and-equity-in-the-united-states-what-can-we-learn-from-pre-pandemic-research-to-inform-relief-recovery-and-rebuilding/>
- 29) Kim, L. E., & Asbury, K. (2020). 'Like a rug had been pulled from under you': The impact of COVID-19 on teachers in England during the first six weeks of the UK lockdown. *British Journal of Educational Psychology*, 90(4), 1062–1083. <https://doi.org/10.1111/bjep.12381>
- 30) Llego, M. (2020). Modular distance learning in the new normal. TeacherPH. <https://www.teacherph.com/modular-distance-learning/>
- 31) Magsambol, B. (2020). Distance learning in the Philippines: A year of hits and misses. Rappler. <https://www.rappler.com/newsbreak/in-depth/distance-learning-hits-misses-year-end-report>



There is an Open Access article, distributed under the term of the Creative Commons Attribution – Non Commercial 4.0 International (CC BY-NC 4.0) (<https://creativecommons.org/licenses/by-nc/4.0/>), which permits remixing, adapting and building upon the work for non-commercial use, provided the original work is properly cited.

The Influence of Achievement Motivation on Burnout in Swimming Athletes



Elsadirra Ayu Melya¹, Christina Fajar Sriwahyuniati², Endang Rini Sukamti³

^{1,2,3} Department of Sport Science, Yogyakarta State University, Yogyakarta Indonesia

ABSTRACT: Currently burnout is a crucial problem in the world of athletes, because it often hampers the performance rate of athletes who ultimately harm themselves and the surrounding environment. The purpose of the study was to influence achievement motivation on burnout in swimming athletes in Sleman Regency. This research is quantitative, with an ex post facto design. The subjects were swimming athletes totaling 75 athletes. The instrument used was a questionnaire. The analysis technique used regression with Statistical Package for Social Science (SPSS) version 21 software. The results show that there is a significant effect of achievement motivation on burnout in swimming athletes in Sleman Regency, with a calculated t value of $-4.080 > t_{table} 1.666$, p-value $0.000 < 0.05$. Negative value, meaning that if achievement motivation is higher, burnout will be lower. The contribution of achievement motivation variables to burnout of swimming athletes in Sleman Regency is 18.60%, while the remaining 81.40% is influenced by other factors outside this study. For future researchers to be able to reveal other variables that can affect burnout in swimming athletes, because our report found only 18.60%.

KEYWORDS: self achievement motivation, burnout, swimming athletes

INTRODUCTION

Athletes are one type of profession that is classified as heavy. This is because athletes are required to constantly improve professionalism. The quality of professionalism in question includes expertise, high concentration, knowledge, being able to behave professionally when faced with problems related to coworkers, coaches, family and opponents. Being an athlete requires hard work from start to finish, such as preparation during hard training, preparing physical conditions, and mental preparation, so it is not uncommon for athletes to experience burnout. Currently burnout is a crucial problem in the world of athletes, because it often hampers the performance rate of athletes who ultimately harm themselves and the surrounding environment. Burnout occurs because the recovery process from the match is inadequate. That means burnout can be caused by too busy a schedule, while the period for player recovery is lacking. Research on the adverse effects of burnout on athletes has pushed the topic to become important among researchers (Gustafsson et al., 2014).

The term burnout was first defined as a pattern of behavior experienced by volunteers from the Free Clinic of New York for drug addicts. This pattern of behavior included a profound loss of energy, decreased individual motivation, and loss of interest in work to the point of exhaustion (De Francisco et al., 2016). Burnout is a condition that is filled with a sense of saturation, so that a lot of energy and energy is wasted. Burnout is generally defined as a cognitive-affective syndrome consisting of emotional and physical exhaustion, a reduced sense of accomplishment, and devaluation of exercise (Gustafsson et al., 2017). Sport burnout is a psychophysiological syndrome that includes physical and emotional exhaustion, decreased achievement as an athlete, indifference to important things, role conflict and role ambiguity experienced by an athlete. The term burnout is defined as a state of physical fatigue, emotional and mental fatigue (Maslach & Leiter, 2016). This symptom is synonymous with a feeling of failure to achieve goals. Saturation can also be interpreted as an attitude where a person is at a level of boredom that affects the person's routine, thus making a sense of participation in a lack of self.

Burnout is a psychological stress, somatic disorder consisting of emotional exhaustion, cynicism and reduced personal accomplishment (Edú-Valsania et al., 2022). Exhaustion is mental fatigue from intense and frequent interpersonal contact. Cynicism is a tendency to withdraw from work. Reduced personal accomplishment is a reduction in personal ability and achievement caused by external factors beyond the individual's control (Lee, 2015). Burnout in the world of sports is something

The Influence of Achievement Motivation on Burnout in Swimming Athletes

that has a bad impact because it can affect achievement (performance and achievement decrease). If athletes experience burnout, especially when competing, it will result in decreased motivation and achievement.

Achievement motivation is the drive within a person to achieve success, which tends to cause behavior to maintain and improve the success that has been achieved by being guided by the best achievements (Brunstein & Heckhausen, 2018). Achievement motivation is closely related to competitive traits and situations. Competitive nature is a tendency to feel satisfied if that is the driving force for behavior. Achievement motivation also affects athlete performance. It can be said that achievement motivation is a "standard of excellence" or a tendency in athletes to perform as well as possible. Athletes who have high achievement motivation have a positive attitude towards a situation that refers to achievement.

Individuals who have high achievement motivation will have a sense of responsibility and high self-confidence, are more resilient, more active in carrying out a task, have a desire to complete their tasks well. Therefore, the achievements achieved will usually be better than individuals with low achievement motives. Individuals will be more resistant to social pressures, prefer to choose friends just familiar friends, in acting always consider moderate levels of risk.

Researchers depart from the assumptions of previous research conducted by Nastiti & Prakoso (Nastiti & Prakoso, 2018) athletes with high burnout conditions have low optimism for achievement. Furthermore, Hafidz's research (Hafidz et al., 2022) stated that petanque athletes train continuously without a match, this makes athletes experience boredom to burnout. In the world of sports, burnout is something that has a bad impact because it can affect achievement (performance and decreased performance). Based on this, the researcher is interested in conducting a study entitled "The Effect of Achievement Motivation on Burnout".

MATERIALS AND METHODS

Participants

The subjects in this study were swimming athletes in Sleman Regency totaling 102 athletes. The sampling technique was carried out by purposive sampling. The criteria are (1) willing to be a sample, (2) over 12 years old, (3) have participated in competitions, (4) still actively practicing. Based on these criteria, 75 athletes met.

Research Design

This type of research is descriptive quantitative with an ex post facto approach. Ex post facto which means after the fact, with survey data collection. Ex post facto research is research that aims to find possible causes of changes in behavior, symptoms or phenomena caused by an event, behavior or things that cause changes in the independent variable which as a whole has already occurred.

There are 6 dimensions of achievement motivation instrument grids, namely responsibility, task selection risk, innovative creativity, feedback, task completion time, and having realistic goals. The dimensions used to compile the burnout scale according to Maslach, namely emotional exhaustion, depersonalization, mental fatigue.

Statistical Analysis

The statistical analysis technique used the Statistical Package for Social Science (SPSS) version 21 software. Tingkat p-value statistik ditetapkan pada p-value < 0.05.

RESULTS

The results of descriptive statistics of self efficacy variables, social support, and achievement motivation of soccer athletes can be seen in Table 1.

Table 1. Descriptive statistics of Achievement Motivation and Burnout

Variable	Mean ± SD
Achievement Motivation	2.33 ± 0.22
Burnout	2.67 ± 0.29

Normality Test

The normality test uses the Kolmogorov-Smirnov Test, namely by looking at the significance value of the residual variable if the p-value > 0.05, it can be said that the data is normally distributed. The results are presented in Table 2.

The Influence of Achievement Motivation on Burnout in Swimming Athletes

Table 2. Normality test results

<i>One-Sample Kolmogorov-Smirnov Test</i>		
		<i>Unstandardized Residual</i>
N		75
Normal Parameters ^a	Mean	0.000000
	Std. Deviation	0.26060650
Most Extreme Differences	Absolute	0.115
	Positive	0.046
	Negative	-0.115
Kolmogorov-Smirnov Z		0.994
Asymp. Sig. (2-tailed)		0.277

Based on the statistical analysis of the normality test that has been carried out using the Kolmogorov-Smirnov test, the normality test results are obtained with an Asymp. Sig (2-tailed) is $0.277 > 0.05$, which means the data is normally distributed.

Linearity Test

The linearity test is used to determine whether the independent variable and the dependent variable in this study have a linear relationship if the increase in the independent variable score is followed by an increase in the dependent variable score. The results of the Linearity test of this study can be seen in Table 3.

Table 3. Linearity test results

Variable	p-value	Description
Achievement motivation on burnout	0.284	Linear

Based on the table above, it can be seen that the relationship between the independent variable and the dependent variable obtained a p-value of $0.284 > 0.05$. So, the relationship between the independent variable (achievement motivation) and the dependent variable (burnout) is declared linear.

Hypothesis Test Results

To determine the effect of achievement motivation on burnout of swimming athletes in Sleman Regency, it is done by analyzing the t test (partial) and F test (simultaneous), the results are as follows:

Table 4. Partial test analysis results (t test)

Model		Unstandardized Coefficients		Standardized	t	Sig.
		B	Std. Error	Coefficients		
1	(Constant)	4.004	0.329		12.187	.000
	Self efficacy	-0.574	0.141	-0.431	-4.080	0.000

Based on the results of the analysis in Table 4, the t value is $-4,080$ and the p-value is $0.000 < 0.05$, so the hypothesis “there is a significant effect of achievement motivation on *burnout* in swimming athletes in Sleman Regency” is accepted. The value is negative, meaning that if achievement motivation is higher, *burnout* will be lower. The results also found an R Square value of 0.186. This means that the contribution of achievement motivation variables to burnout of swimming athletes in Sleman Regency is 18.60%, while the remaining 81.40% is influenced by other factors outside this study.

DISCUSSION

Based on the results showed that there is a significant influence between achievement motivation on burnout of swimming athletes in Sleman Regency, with a p-value < 0.05 , the results of the study are negative, meaning that the higher the level of achievement motivation, the lower the burnout of athletes. Based on the Coefficient of Determination (R²), it is known that the coefficient of determination R Square is 0.186. This means that the contribution of achievement motivation variables to the

The Influence of Achievement Motivation on Burnout in Swimming Athletes

burnout of swimming athletes in Sleman Regency is 18.60%, while the remaining 81.40% is influenced by other factors outside this study.

The results of this study are supported in a study conducted by Akhyar (Akhyar et al., 2017) which aims to determine the relationship between achievement motivation and burnout in student athletes in Semarang City. The results showed that there was a significant negative relationship between achievement motivation and burnout ($r = 0.248$; $p = 0.018 < 0.05$). The coefficient of determination of achievement motivation on burnout with a contribution of 15.78%. The higher the achievement motivation of athletes, the lower the burnout experienced by athletes.

While the value of the relationship between achievement motivation and burnout is inversely proportional. This means that the greater the athlete's achievement motivation, the smaller the risk of burnout. The involvement of motivation is expected that the athlete's mentality is in good condition. Athletes with a tough mentality provide protection against experiencing burnout symptoms (Madigan & Nicholls, 2017). In addition to athletes taking the initiative to motivate themselves, coaches can also provide lectures or advice after training. That way athletes feel motivated to do better in training, so that they can minimize the occurrence of burnout. The coach's action in motivating his athletes is a form of social support that can be applied through oral and written communication. A significant negative relationship between social support and burnout. This means that the score of burnout and social support has an inverse value. The lower the social support, the higher the burnout score, and vice versa.

Achievement motivation can help individuals complete tasks well, besides that it can spur athletes to study harder and have full concentration in the training and competition process. Athletes who have high achievement motivation have several characteristics such as, having high motivation to achieve success, focus on the desire to succeed, still have good performance even though they get a lot of evaluation, and so on (Zach et al., 2017). Athletes who have some of the above characteristics can easily overcome burnout and continue to produce achievements in the field of sport they are engaged in.

Achievement motivation will make athletes have clear goals and can help these athletes achieve the expected success. Individuals who have high achievement motivation will want feedback and not experience potential frustration. Achievement motivation will be able to direct students to do something better and make athletes able to see the goal of achievement. Achievement motivation will also provide a clear view for the future. Achievement motivation possessed by athletes will produce an optimistic attitude and bring up efforts in facing existing challenges.

As is experienced by everyone, even athletes must have felt the name boredom or boredom, especially when participating in training. This opinion is reinforced by Wolff et al., (Wolff et al., 2021) which explains, boredom can be experienced by anyone in daily life activities, including in the context of sports. Burnout is a condition of physical or emotional exhaustion, depersonalization, and decreased personal achievement due to the continuous demands of work or training. Burnout is a form of fatigue that arises as a result of someone who is too intense in their activities, has high commitment and dedication, and has many wants and needs that must be met.

In the context of sports, specifically athletes are described as experiencing boredom over routine training. The reciprocal is that the training that was originally undertaken with enthusiasm turns into boring and athletes seem less productive undergoing training than usual. Burnout is a condition of athletes who initially respond enthusiastically to training, then turn into bored or boring activities. Burnout that occurs in athletes can occur due to several things such as situational demands (too high expectations, lack of social support), psychological responses (decreased motivation, fatigue), behavioral responses (decreased performance, difficulty in interpersonal relationships), and others.

Factors affecting burnout are divided into intrinsic and extrinsic, with details of intrinsic factors including; determination, self-awareness, discipline, and mentality, while extrinsic factors include diversity of training programs, communication, facilities, salary or gift bonuses, and training program design in terms of individual abilities. These factors can be improved in diverting from training burnout Athletes with strong willpower tend to feel more prepared. This feeling of readiness is needed to combat laziness in participating in training. Feeling ready for athletes will provide optimism and a feeling of resilience in undergoing training sessions.

The occurrence of burnout is also due to training not having variety or being too monotonous. If this is not addressed and continued, it is possible that the athlete will find training more nauseating and less challenging. Higher levels of burnout lead to faster physical decline. This situation is certainly not something that is expected. But on the contrary, athletes are expected to have adequate physical fitness. Overtraining, lack of fun, and too much pressure from self and others are sources of burnout (Kellmann, 2004).

The implications of burnout on athletes are a problem that cannot be underestimated because it can affect the athlete's performance, fitness level, motivation, and psychological state (Lu et al., 2016). Furthermore, at a more severe level the result of burnout is that athletes resign or stop being athletes. Another term is dropout. Boredom is the main reason athletes stop exercising, from children to professional athletes. According to (Schwartz et al., 2021) coaches and athletes should pay attention

The Influence of Achievement Motivation on Burnout in Swimming Athletes

to boredom as a potential early warning signal to potentially become more severe. As a result of the boredom experienced, it is not surprising that training will be done lightly, such as underestimating the warmup. If the lack of seriousness continues, it will potentially lead to injury during the training session. Burnout is a risk factor for future injury.

Burnout has been shown to cause a variety of damaging psychophysiological and behavioral outcomes, in the form of negative consequences that include: depressed mood and psychological stress (Gustafsson et al., 2017). Athletes who suffer from stress tend to be less enthusiastic in practicing. Indications of stress felt by athletes are reliable predictors of burnout (De Francisco et al., 2016). Furthermore, coaches need to monitor the symptoms of burnout so that they are addressed immediately. Some athletes, among others, can show symptoms of active burnout even though they do not make a resignation (dropout). The condition of active burnout symptoms indicates that boredom is actually felt, and the deepest desire arises to stop being an athlete, but this cannot be done because there are specific causes that do not allow it to leave, such as demands from family (Kellmann, 2004).

In addition, the training program should not be too monotonous. Therefore, trainers need to plan a varied training program. It also doesn't hurt if the training program adds an element of fun in it to avoid boredom. Although training is fun, it still refers to the predetermined program, so that the training process runs continuously and in accordance with the performance targets to be achieved. The application of game sports methods is considered effective in dealing with boredom. Because the main orientation of game sports is to provide a feeling of fun and entertainment. This method can be applied by the coach at the end of the session or after training. Conversely, it is hoped that athletes will also take the initiative to increase motivation in the form of determination, self-awareness, and a feeling of readiness to participate in training, in order to anticipate feelings of boredom or saturation.

CONCLUSIONS

Based on the results of data analysis, description, testing of research results, and discussion, it can be concluded that there is a significant effect of achievement motivation on burnout in swimming athletes in Sleman Regency, with a calculated t value of $-4.080 > t$ table 1.666 , p -value $0.000 < 0.05$. Negative value, meaning that if achievement motivation is higher, burnout will be lower. The contribution of achievement motivation variables to burnout of swimming athletes in Sleman Regency is 18.60% , while the remaining 81.40% is influenced by other factors outside this study.

REFERENCES

- 1) Akhyar, A. G., Priyatama, A. N., & Setyowati, R. (2017). Burnout ditinjau dari hardines dan motivasi berprestasi (Studi pada atlet pelajar di Semarang). *Insight: Jurnal Pemikiran Dan Penelitian Psikologi*, *13*(2), 113–125.
- 2) Brunstein, J. C., & Heckhausen, H. (2018). Achievement motivation. *Motivation and Action*, 221–304.
- 3) De Francisco, C., Arce, C., del Pilar Vilchez, M., & Vales, Á. (2016). Antecedents and consequences of burnout in athletes: Perceived stress and depression. *International Journal of Clinical and Health Psychology*, *16*(3), 239–246.
- 4) Edú-Valsania, S., Laguía, A., & Moriano, J. A. (2022). Burnout: A review of theory and measurement. *International Journal of Environmental Research and Public Health*, *19*(3), 1780.
- 5) Gustafsson, H., DeFreese, J. D., & Madigan, D. J. (2017). Athlete burnout: Review and recommendations. *Current Opinion in Psychology*, *16*, 109–113.
- 6) Gustafsson, H., Hancock, D. J., & Côté, J. (2014). Describing citation structures in sport burnout literature: A citation network analysis. *Psychology of Sport and Exercise*, *15*(6), 620–626.
- 7) Hafidz, A., Suryanto, S., & Priambodo, A. (2022). Problematik psikososial pada atlet cabang olahraga petanque. *Jurnal Psikologi Teori Dan Terapan*, *13*(1), 39–50.
- 8) Kellmann, M. (2004). *Overtraining and burnout in sports*.
- 9) Lee, R. T. (2015). *Wellbeing and Burnout in the Workplace*, *Psychology of*.
- 10) Lu, F. J. H., Lee, W. P., Chang, Y.-K., Chou, C.-C., Hsu, Y.-W., Lin, J.-H., & Gill, D. L. (2016). Interaction of athletes' resilience and coaches' social support on the stress-burnout relationship: A conjunctive moderation perspective. *Psychology of Sport and Exercise*, *22*, 202–209.
- 11) Madigan, D. J., & Nicholls, A. R. (2017). Mental toughness and burnout in junior athletes: A longitudinal investigation. *Psychology of Sport and Exercise*, *32*, 138–142.
- 12) Maslach, C., & Leiter, M. P. (2016). Burnout. In *Stress: Concepts, cognition, emotion, and behavior* (pp. 351–357). Elsevier.
- 13) Nastiti, R. F., & Prakoso, H. (2018). Hubungan antara Optimisme dengan Burnout pada Atlet Bulutangkis Tunggal Remaja di Klub SGS PLN. *Prosiding Psikologi*, 172–177.

The Influence of Achievement Motivation on Burnout in Swimming Athletes

- 14) Schwartze, M. M., Frenzel, A. C., Goetz, T., Pekrun, R., Reck, C., Marx, A. K. G., & Fiedler, D. (2021). Boredom makes me sick: Adolescents' boredom trajectories and their health-related quality of life. *International Journal of Environmental Research and Public Health*, *18*(12), 6308.
- 15) Wolff, W., Bieleke, M., Martarelli, C. S., & Danckert, J. (2021). A primer on the role of boredom in self-controlled sports and exercise behavior. *Frontiers in Psychology*, *12*, 637839.
- 16) Zach, S., Xia, Y., Zeev, A., Arnon, M., Choresh, N., & Tenenbaum, G. (2017). Motivation dimensions for running a marathon: A new model emerging from the Motivation of Marathon Scale (MOMS). *Journal of Sport and Health Science*, *6*(3), 302–310.



There is an Open Access article, distributed under the term of the Creative Commons Attribution – Non Commercial 4.0 International (CC BY-NC 4.0) (<https://creativecommons.org/licenses/by-nc/4.0/>), which permits remixing, adapting and building upon the work for non-commercial use, provided the original work is properly cited.

PISA-Based Assessment Instrument In Javanese Language Learning Grade VIII



Iriana Famuji Widodo¹, Suwarnda², Venny Indria Ekowati³

^{1,2}Master of Javanese Language Education Study Program, FBSB, UNY, Indonesia

³Undergraduate of Javanese Language Education Study Program, FBSB, UNY, Indonesia

ABSTRACT: This study aims to develop and evaluate PISA based assessment tools for Javanese language learning grade VIII. This research used the research and development (RD) method with the ADDIE model including the stages of analysis, design, development, validation and testing, and media evaluation. PISA-based standard media for evaluating Javanese language learning were developed using the WordPress application and evaluated by a material expert, a media expert, and teachers of Javanese language. The data were collected using questionnaires and analyzed descriptively. The results of the study show that the quality of the assessment media was highly rated by material experts (87.90%), media experts (100%) and Javanese language teachers (100%). Students' opinions on the Javanese language assessment tool were also very positive (85.76%). Overall, the average rating of media quality was 93.42% categorized as Very Good. This research makes a significant contribution to the development of PISA-based evaluation media for Javanese language learning.

KEYWORDS: PISA, Assessment Instruments, Javanese, Learning, ADDIE

I. INTRODUCTION

Learning is one of the activities carried out by teachers and students in direct interaction (Febrita Ulfah, 2019). Learning also means the process of communicating materials from the source to the receiver using certain media (Sanaky, 2009). In the communication process, the transferred message must be able to be absorbed and lived by the person receiving the message. The communication process in learning has certain components, including the teacher as the communicator or messenger, the student as the communicator or receiver of the message, the learning material as the message, the learning media as the means of conveying the message, and other factors in the form of feedback in learning.

Learning and learning assessment are closely linked in the educational process. This is because the evaluation is one of the processes to assess the problem. Evaluation is also used to gain feedback to improve and optimize the learning process. Evaluation is usually qualitative (Ningsih, 2012). Evaluation also means the systematic assessment of the usefulness of an object (Stufflebeam Shinkfield, 1985). Rules are usually used in the evaluation process, which are taken into account in making decisions. The purpose of evaluation is to find out the extent of the impact of a program by comparing the results with the objectives set. In addition, evaluation also aims to determine the effectiveness of programs that have or have not been achieved as planned. In evaluation, there are steps of conducting tests that need to be fulfilled. The test can be considered a good measurement tool if it fulfills test requirements, including validity, reliability, objectiveness, practicality, and cost-effectiveness (Rapono, Safrial, & Wijaya, 2019).

PISA (Program for International Student Assessment) is one of the products of the OECD (Organization for Economic Cooperation and Development). PISA is an international assessment program that aims at evaluating the education of participating countries. PISA is one of the tests used to measure students' reading, writing, and math skills. Reading literacy is one of the aspects assessed to determine the quality of education. Several studies have shown that the skills of students in Indonesia are still low (OECD, 2016; Putrawangsa & Hasanah, 2018; Putrawangsa & Syawahid, 2018). This is because students in Indonesia are not able to recognize the main idea of reading.

Based on the latest PISA results, on December 5, 2023, the skills of students in Indonesia dropped. The local government of Yogyakarta is trying to improve the PISA result. One of the ways is to implement the ASPD (Regional Education Assessment) program. The program is implemented to increase students' enthusiasm for learning. This can be seen by the fact that the PISA

PISA-Based Assessment Instrument In Javanese Language Learning Grade VIII

results in DIY is at the first rank in Indonesia. Therefore, the government has conducted OECD research to improve the quality of education in Indonesia. One of them is by developing the curriculum, namely from Curriculum 2013 to Kurikulum Merdeka (the Emancipated Curriculum). Local content lessons are mandatory at school for grade IV SD/MI/SDLB, SMP/MTs/SMPLB, SMA/MA/MALB, and SMK. Regarding the existence of PISA, of course, Javanese language learning must also contain the assessment instruments of PISA-type question. This is because the Emancipated Curriculum has literacy content. Therefore, the emancipated curriculum is used in all schools in the Yogyakarta Special Region.

Literacy and language skills are closely related and complement each other. Literacy programs can improve language skills and vice versa. Language skills are divided into four areas, namely reading, writing, speaking, and listening (Setyowati, Hartono, Sriyanto, 2014). Based on language proficiency in Javanese language learning, it can be used as a means to improve PISA scores. When creating PISA questions, there are of course rules that need to be mastered by teachers, as not many teachers have the skills to create PISA questions. Materials for reading, writing, and arithmetic in Javanese have been included in the curriculum, especially in secondary schools. The development of media for learning Javanese is widespread, but there is no learning media that focuses on practicing with PISA question types.

Media is a tool to transmit messages or information from sources to recipients (Hidayatullah Haryadi, 2018). Meanwhile, learning media is a tool or means to convey materials from sources or teachers to recipients or students in the learning process (Latuheru, 1988). In addition, learning media can also be in the form of books, tape recorders, videotapes, movies, slides, photographs, pictures, televisions, and computers that contain learning materials (Azhari, 2015). The types of learning media are categorised into three, namely audio media, visual, and audio-visual (Aghni, 2018). Learning media undoubtedly has benefits for students. They can attract students' attention, make the material more interesting, bring students' understanding to the same level when mastering the material, make it easier for students to understand the material, students can learn independently, and students can more easily translate abstract meanings into concrete ones (Latuheri, 1988).

The rapid development of information technology has enabled the integration of computers into various aspects of learning, one of which is their use in learning assessment. Computers are one of the outcomes of modern technology used in learning. Even though it is a modern technology, computers also have disadvantages instead of its advantages. Computer media can also be used by students independently in the assessment process. Computers as means of practicing questions are divided into two types, namely Computer Assisted Instruction (CAI) and Computer Managed Instruction (CMI). The CAI evaluation process allows students to interact directly using a computer in which learning materials and assessments are stored. The CMI evaluation process, on the other hand, is used as a means for teachers to organize evaluations related to the evaluation management system (Latuheru, 1988).

WordPress is not only used to create websites but can also be used as a medium for learning assessment. WordPress can be used as an application to design writing, audio, video, and animation in the form of blogs. The WordPress application has many versions that are always updated with features. In addition, WordPress also has advantages over other programs. The one of advantages of WordPress is its ability to produce small-sized files even though the program results are in the form of animation. This study used WordPress 5.0 that has been widely used for evaluation and learning media. The learning media made using this program can attract students' attention because it contains animation. The media made in this study is expected to be applied as means of evaluating Javanese language learning based on PISA for grade VIII of junior high school.

Therefore, Javanese language teachers need to create media for Javanese language learning instrument in the form of multimedia that can automatically determine student scores, especially for the grade VIII students of junior high school. Javanese language learning instrument media is made using the ADDIE (Analysis, Design, Development, Implementation, Evaluation) development procedure connected to the WordPress application. This study aims to explain how to develop PISA-based standard evaluation instrument media.

II. RESEARCH METHODS

This research is a type of Research and Development (RD) research using the ADDIE method, a development model from Branch. This RD research aims to produce products that can be tested empirically (Gustiani, 2019). The research steps carried out in the ADDIE method are the analysis stage, the instrument design stage, the instrument-making stage, the validation and trial stage, and the evaluation stage (Yulia, Riadi, Nursanni, 2023). The data sources of this research are validators, and Javanese language teachers as well as students of SMP Negeri 4 Wates. PISA-based assessment instruments were used for Javanese language learning in grade VIII and were validated by a material expert (a lecturer) and a media expert (a lecturer). The data were collected using questionnaires. The data were analysed using descriptive analysis based on the evaluation of the instrument and students' opinions. The instruments were validated using external and internal validity (Merrydian et al, 2024). The reliability of the instrument was tested using the triangulation method of data sources.

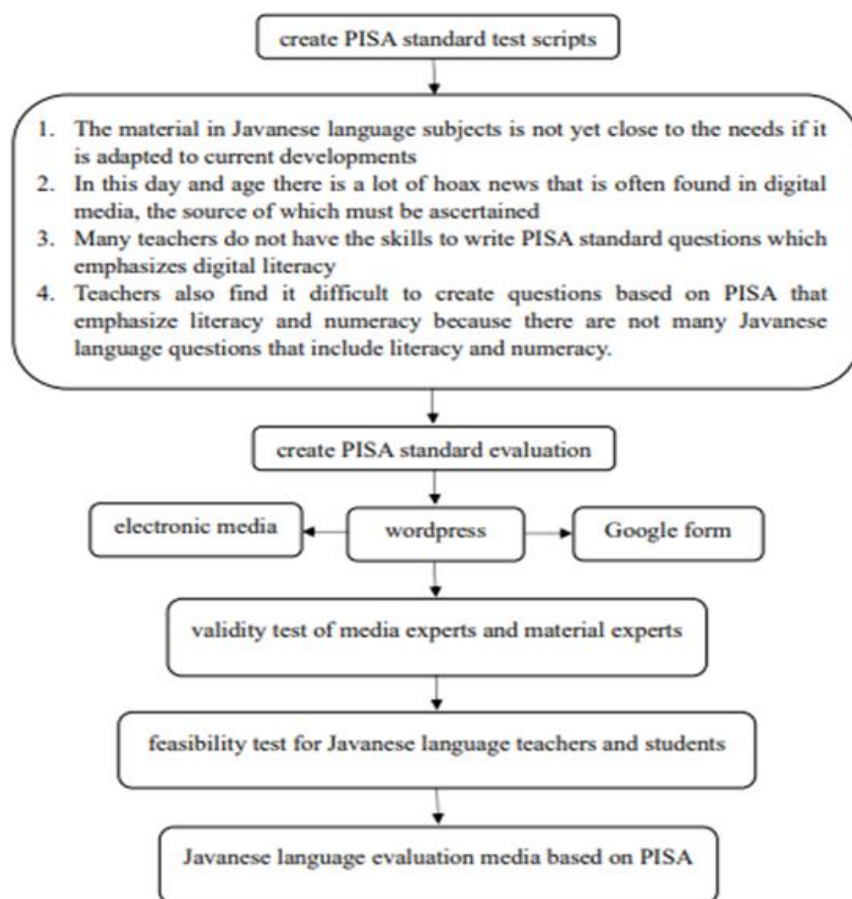

Figure 1. Cognitive process dimension

III. RESULTS AND DISCUSSION

PISA-based standard evaluation media were developed using the RD research method. The creation of this evaluation media consists of five stages, namely analysis, media design, media development, media validation and trials, and media evaluation. These stages are also called the ADDIE (Analysis, Design, Development, Implementation, Evaluation) development procedure. The discussion of development stages of PISA-based standard evaluation instrument for Javanese language learning is below.

A. Analysis

The analysis stage is the first step that must be done before making a product. In this study, the analysis stage is divided into three, namely curriculum analysis, technology analysis, and needs analysis of grade VIII students of SMPN 4 Wates which is carried out through observation. Curriculum analysis is carried out by looking at the curriculum used in Javanese language learning at the school so that the media to be made is in accordance with the curriculum. Currently, SMPN 4 Wates uses the Emancipated Curriculum which is supported by literacy and numeracy competencies as contained in the PISA program.

Working on PISA questions requires the ability to analyse its questions, because PISA questions cannot be solved in a single step. In addition, the PISA questions also contain reading material relating to everyday problems and technological progress. The ability to deal with PISA standard questions can also influence the success of the curriculum used in schools. Based on the observation results, SMPN 4 Wates students need examples of questions that use PISA standards, as these questions may not capture students' attention and seem old-fashioned. In addition to analysing the curriculum, a technology analysis is also conducted to identify the software or computer software that can be used to create media. Therefore, in this study, the PISA-based media assessment tool takes the form of a website created using the WordPress application and linked to Google Forms. The media was created to draw students' attention to learning the Javanese language.

B. Media Design

It is the second step in ADDIE's development procedure aiming to determine the content of the learning media. The product design is made through an interactive website using materials and questions as practice materials to assess students' skills. During the evaluation process, the teacher continues to act as a controller and informant in the classroom. In other words, the evaluation process must be interactive and educational so that students are enthusiastic and happy in learning.

PISA-Based Assessment Instrument In Javanese Language Learning Grade VIII

The design of the PISA-based Javanese language learning evaluation instrument was made based on the things found in the analysis stage. There are two things that are done in the stage of creating a media design, namely making a flowchart and storyboard. Flowcharts are used as guidelines in designing learning media that contain the form and content of learning.

C. Media Development

It is the third stage in the process of making PISA-based standard Javanese language learning evaluation instruments. The flowchart that discusses the content of learning is processed into Javanese language material for grade VIII. Flowchart and complete materials are used as scripts for Javanese language learning evaluation instruments. The instrument contains a registration menu as a form of home, *pituduh* (the guidance) as the manual, the Javanese PISA test as a form of evaluation questions, *pangrakit* as information for media makers, and answer keys. The manuscript of the Javanese language learning evaluation instrument based on the PISA standard was made using the WordPress application and equipped with a google form.

D. Media Validation and Trials

The validation and trial stages can be carried out after the evaluation instrument media is created. The validation process requires expert judgement from the material expert and the media expert. The validation process is carried out in order to get suggestions and evaluations of media products that have been made. If the developed media is feasible, a trial process will be carried out.

1. The Validation of Media and Materials

The validation from a material expert is carried out to obtain suggestions and evaluations of the materials in the learning evaluation media. The validation process is carried out by providing an evaluation questionnaire to a materials expert that contain several aspects of assessment. The materials expert was Mrs. Dr. Nurhidayati, S.Pd., M.Hum. The validation carried out by the materials expert was the material feasibility test which would later be tested on SMPN 4 Wates students. In addition, validation by a subject-matter expert includes several assessment indicators described in the table below.

Table 1. Results of the Material Validation by an Expert Lecturer

No.	Indicator		Stage I		Stage II		
			Item	Category	Item	Category	
1.	Reading Competency		The ability to retell the information	3	Good	4	Very good
			Interpretation development	3	Good	4	Very good
2.	Critical Thinking		Reflecting and evaluating text	2	Less than Satisfactory	3	Good
3.	Linguistic Aspects Used		Using complex sentences in the form of tables	2	Less than Satisfactory	4	Very good
			Using complex sentences in the form of diagrams	3	Good	3	Good
			Using complex sentences in the form of graphs	4	Very good	4	Very good
4.	Assessment Preparation by Information	Process Seeking	Accessing and retrieving information from the text	3	Good	4	Very good
			Searching for and selecting relevant text	3	Good	3	Good
5.	The Process of Preparing an Assessment Understanding	of with	Understanding the literal meaning of a sentence or short passages	3	Good	3	Good
			Integrating and generating conclusions	3	Good	4	Very good
			Integrating and generating	3	Good	4	Very good

PISA-Based Assessment Instrument In Javanese Language Learning Grade VIII

No.	Indicator	Stage I		Stage II		
		Competency	PISA Characteristics	Item	Category	Item
		conclusions from many sources				
6.	The Process of Preparing Assessments by Evaluating and Describing	Evaluating whether the information in the text is valid	2	Less than Satisfactory	3	Good
		Reflecting on the content of the text by evaluating and determining how the author expresses their purpose and/or point of view	3	Good	4	Very good
		Finding and overcoming conflicts	2	Less than Satisfactory	3	Good
7.	The characteristic of text format	Single	4	Very good	4	Very good
		Many sources	3	Good	3	Good
8.	Characteristics of Text Format - Settings and Navigation	Static	4	Very good	4	Very good
		Dynamic	2	Less than Satisfactory	3	Good
9.	The characteristic of text format	Continue	3	Good	3	Good
		Non-continue	3	Good	3	Good
		Mixed-format	2	Less than Satisfactory	3	Good
10.	The characteristic of text format – Text types	Description	-	-	3	Good
		Narrative	3	Good	4	Very good
		Exposition	3	Good	4	Very good
		Argumentation	4	Very good	4	Very good
		Instruction	3	Good	3	Good
		Transactional	3	Good	3	Good
11.	The characteristic of answer formats	Multiple choice	4	Very good	4	Very good
		Complex multiple choice	4	Very good	4	Very good
		Closed Essay	3	Good	4	Very good
		Open Essay	3	Good	3	Good
Total Grade			90		109	
The percentages of Items			72,58 %	Good	87,90%	Very good

Based on the table above, it can be seen that there are eleven Competencies for PISA questions, namely reading competency, critical thinking, linguistic aspects used, assessment preparation process by seeking information, the process of preparing an assessment with understanding, the process of preparing assessments by evaluating and describing, the characteristic of text format, characteristics of text format - settings and navigation, the characteristic of text format, the characteristic of text format – text types, and the characteristic of answer formats (OECD, 2002; OECD, 2010; OECD, 2016; OECD, 2017; OECD,2019a; OECD,

PISA-Based Assessment Instrument In Javanese Language Learning Grade VIII

2019b; OECD, 2019c; OECD, 2019d; OECD, 2019e; OECD, 2021; OECD, 2023). Each Competency has its own PISA Characteristic. The assessment of material expert lecturers in the first stage received a percentage of 72.58% which was included in the good category. Even though it is included in the Good Category, the questions must be revised. According to the material expert lecturer, there are several things that must be revised, including changing question numbers that do not match the PISA Characteristic, combining question numbers that have the same PISA Characteristic, adding questions that are in accordance with the PISA Characteristic, correcting spelling in writing words, adjusting answers to multiple-choice questions that are not equivalent, and adjusting the use of language. After being revised, the assessment of the materials expert in the second stage gave score of 87.90% which is categorized as Very Good. The lecturer who was the subject-matter expert has also given approval that the PISA questions are suitable to be used in the media.

The validation from the media expert aims to get advice and evaluation regarding the quality of the media. The media expert was provided with an evaluation questionnaire containing graded aspects. Suggestions from the media expert are then used to improve the quality of the media. The lecturer who became the validator was Dr. Doni Dwi Hartanto, S.Pd., M.Pd. Validation carried out by the media expert is carried out until the media is considered well-meaning of being tested on SMPN 4 Wates students. Validation by the media expert is divided into two, namely the display aspect and the programming aspect. Validation related to the display aspect consists of 10 indicators, while validation related to the programming aspect consists of 9 indicators.

Table 2. The Results of the Validation of a Media Expert (a Lecturer) related to the Display Aspect

No	Statement	Stage I		Stage II	
		Grade	Category	Grade	Category
1.	The operation ease of the menu	3	Good	4	Very good
2.	The readability of writing	4	Very good	4	Very good
3.	The choice and composition of colours	4	Very good	4	Very good
4.	The image presentation	4	Very good	4	Very good
5.	The visual design and content layout	3	Good	4	Very good
Total Grade		18	Very good	20	Very good
The Grade Percentage		90%		100%	

Based on the table above, it can be seen that the validation from the media expert related to the display aspect got a 90% percentage considered as Very Good. Even though this percentage is included in the Very Good Category, there were advices from the media expert to improve the quality of media displays. According to the media lecturer, two things need to be improved in the appearance of the media. First, the media needs to be given a menu related to instructions for use to make it easier for students to use the *pisajawa* media. Second, the display of the media must be consistent so that the display of inappropriate questions needs to be improved. After being revised, the assessment of media expert lecturers in the second stage obtained a percentage of 100% which is categorized as Very Good.

Table 3. Results of Validation of a Media Expert (a lecturer) related to Programming Aspects

No	Statement	Stage I		Stage II	
		Grade	Category	Grade	Category
1.	Ease of menu usage	4	Very good	4	Very good
2.	Display support in the media	3	Good	4	Very good
3.	The accessibility of the media	4	Good	4	Very good
4.	The media interactiveness	4	Good	4	Very good

PISA-Based Assessment Instrument In Javanese Language Learning Grade VIII

Total Grade	13	Very good	16	Very good
The percentage of the grade	81,25%		100%	

Based on the table above, it can be seen that the validation from lecturers who are media experts related to the programming aspect received 81.25% which is included in the Very good Category. Even though this percentage is included in the category of feasible use, media expert lecturers still provide suggestions to improve the quality of media programming. According to the media expert lecturer, there are three things that need to be improved in media programming. First, the display support power indicator needs to be improved by adding a lock menu in the media. Second, the media indicator for accessibility needs to be improved by adding additional menus or buttons. Third, media indicators can be used interactively and can still be improved by adding information to the PISA test menu and menu keys. After being revised, the assessment of the media expert in the second stage scored a percentage of 100% which is categorized as Very Good. Therefore, the Javanese language learning evaluation media is considered very feasible from the aspect of display and programming to be tested on SMPN 4 Wates students.

2. Media Trials

Trying out the assessment media is an important process to ensure that the created evaluation tools are valid, reliable, and effective in measuring what is supposed to be measured. The main purpose of this trial is to identify shortcomings or weaknesses in the assessment medium so that it can be improved before it is widely used. This media trial was carried out by teachers and students of SMPN 4 Wates. After conducting a trial, teachers and students of SMPN 4 Wates gave an evaluation of the media made. Teachers provided assessments on the media in terms of the quality of media from the aspect of concept and competency as well as the aspect of media display. The media quality assessment was carried out by Ibu Bethy Mahara Setyawati, S.Pd. She is one of the Javanese language teachers at SMPN 4 Wates. Teachers can first-hand see the use of media during the learning process. Teachers' assessment of the quality of the media can be seen in the table below.

Table 4. Results of media trials from the concept and competency aspects by the teacher

No.	Statement	Grade	Category
1.	The conformity between the developed material and PISA standard literacy and numeracy competency	4	Very good
2.	The language clearness and ease of understanding	4	Very good
3.	Variation of difficulty levels (easy, medium, hard) of the questions	4	Very good
4.	The accordance of materials with the Emancipated Curriculum	4	Very good
5.	The Media relevance in determining students' Javanese language skills based on PISA standards	4	Very good
Total Grade		20	Very good
The percentage of grade		100%	

Based on the table above, it can be seen that the percentage of media quality in the concept and competency aspects by Javanese language teachers was 100% which is categorized as Very Good. The indicators carried out by teachers are the conformity between the developed material and PISA standard literacy and numeracy competency, the language clearness and ease of understanding, variation of difficulty levels (easy, medium, hard) of the questions, the accordance of materials with the Emancipated Curriculum, and the media relevance in determining students' Javanese language skills based on PISA standards.

Table 5. Results of media trials from the aspect of display by the teacher

No.	Statement	Grade	Category
1.	The ease of media usage	4	Very good
2.	The display of the media	4	Very good
3.	The design and images in the media	4	Very good
4.	The visual design and layout of the content	4	Very good
5.	The text readability	4	Very good
Total Grade		20	Very good
The percentage of grade		100%	

Based on the table above, teachers of Javanese language perceived that assessment media quality in the aspect of display is categorized as Very Good. The indicators carried out by the teacher are the ease of media usage, the display of the media, the design and images in the media, the visual design and layout of the content, and the text readability. In addition to conducting trials and evaluations with teachers, students were also involved in evaluating the media. Students provided suggestions through questionnaires in the form of Google Forms. The media was evaluated by students from two aspects, namely the concept and competency aspects and the media display aspect which can be seen in the table below.

Table 6. Results of media trials from the aspect of concept and competency by students

No.	Statement	Dominant Grade	Category
1.	Questions containing numeracy and literacy	51,5%	Very good
2.	Questions containing analysis	97%	Yes
3.	The presence of easy questions	75,8%	Yes
4.	The presence of medium difficulty level questions	97%	Yes
5.	The presence of difficult/hard questions	69,7%	Yes

Table 7. Results of the media trial from the aspect of display by students

No.	Statement	Dominant Grade	Category
1.	The ease of media usage	51,5%	Very good
2.	The display of the menu in the media	57,6%	Very good
3.	The design and images in the media	54,5%	Very good
4.	The visual design and content layout	60,6%	Very good
5.	The text readability	48,5%	Very good

Based on the table on the students' evaluations, it can be seen that the evaluation media are already of good quality both in terms of concept and skills and in terms of appearance. In other words, the evaluation media are practicable. This can be seen from the results of the questionnaire determining that the evaluation medium receives the dominant score of Very Good. In addition, the questions are in line with the learning objectives and are able to differentiate between students with high and low ability as shown by the results of the study. The presentation of this assessment media is very interesting and interactive, making students feel motivated to complete the questions. The use of pictures and animations makes the assessment process more enjoyable.

PISA-Based Assessment Instrument In Javanese Language Learning Grade VIII

E. Media Evaluation

The evaluation stage in the ADDIE model is very important to ensure that the media developed is effective and of high quality. By conducting systematic and continuous evaluation, the media can be improved by its quality. This is related to feedback from lecturers, teachers, and students given at the validation and trial stages. The results of the feedback were realized so that the quality increased and was ready to be used widely. Below is the image of PISA-based standard Javanese language learning evaluation media using the WordPress application.

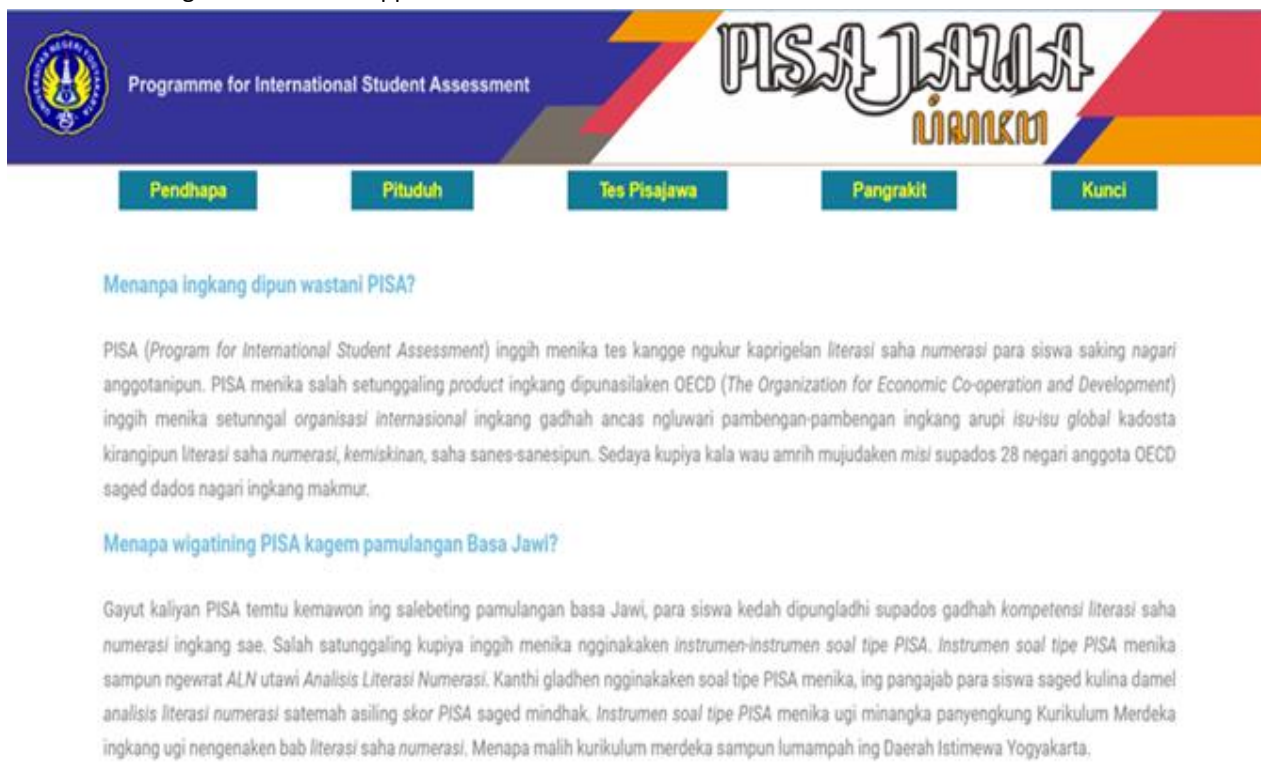

Figure 2. Media evaluation on using the WordPress application

IV. CONCLUSION

This RD research has yielded a product in the form of an assessment medium for Javanese language learning with PISA standard questions. This evaluation media was created with the WordPress application and using Google forms for students to complete the PISA standard questions on Javanese language. The process of creating evaluation media based on the ADDIE procedure is done in several steps to create evaluation media that are suitable for use. Validation and testing by instructors who know the material, instructors who know the media, teachers and students play an important role in determining the feasibility of the media. Various suggestions and improvements during the validation and testing process help to improve the quality of the media. Finally, after validation and testing, these evaluation media can be included in the Very Good category. In addition, the PISA-based evaluation media for Javanese language learning using WordPress is one of the learning innovations relevant to the times and technology. This media allows students to become more proficient in PISA-standardized Javanese item questions.

REFERENCES

- 1) Aghni, Rizqi Ilyasa. 2018. Fungsi dan Jenis Media Pembelajaran dalam Pembelajaran Akuntansi. *Jurnal pendidikan akuntansi Indonesia*, 16(1), 98-107. <https://journal.uny.ac.id/index.php/jpakun/article/view/20173/10899>.
- 2) Azhari. 2015. Peran Media Pendidikan dalam Meningkatkan Kemampuan Bahasa Arab Siswa Madrasah". *Jurnal Ilmiah Didaktika*, 16(1), 43-60. <http://dx.doi.org/10.22373/jid.v16i1.586>.
- 3) Febrita, Yolanda., & Ulfah, Maria. 2019. Peranan Media Pembelajaran untuk Meningkatkan Motivasi Belajar Siswa. *Diskusi Panel Nasional Pendidikan Matematika*, 5(1), 181-188. <https://proceeding.unindra.ac.id/index.php/DPNPMunindra/article/view/571/160>.
- 4) Gustiani. S. 2019. Research and development (R&D) Method as a Model Design in Educational Research and Its Alternatives. *Holistics (Hospitality and Linguistics): Jurnal Ilmiah Bahasa Inggris*, 11(2), 12-22. <https://jurnal.polsri.ac.id/index.php/holistic/article/view/1849>.

PISA-Based Assessment Instrument In Javanese Language Learning Grade VIII

- 5) Hidayatullah, M., & Haryadi. Efektivitas Media Permainan Simulasi dan Media Gambar Peristiwa terhadap Prestasi Belajar Materi Teks Diskusi. *Diksi*, 26(1), 29-39. <https://journal.uny.ac.id/index.php/diksi/article/view/16013>.
- 6) Latuheru, John D. 1988. *Media Pembelajaran dalam Proses Belajar Mengajar Masa Kini*. Jakarta: Depdikbud.
- 7) Merrydian, Siska., et al. 2024. Systematic Literature Review: Validitas Internal dan Eksternal dalam Desain Eksperimen. *EduInovasi: Journal of Basic Educational Studies*, 4(3), 987-1001. <https://journal-laaroiba.com/ojs/index.php/edu/article/view/2734/2526>
- 8) Ningsih, Nuroktya. 2012. Hambatan guru Pendidikan Kewarganegaraan dalam pelaksanaan evaluasi pembelajaran di SMAN 1 Sanden. *Jurnal citizenship*, 1(2), 123-132. <https://sofianingrumhampatra.WordPress.com/wp-content/uploads/2013/03/jurnal-evaluasi.pdf>.
- 9) OECD. 2002. *PISA Reading for Change: Performance and Engagement Across Countries*. Paris: OECD Publishing. https://www.google.co.id/books/edition/PISA_Reading_for_Change_Performance_and/4FBT4Acre64C?hl=id&gbpv=0.
- 10) OECD. 2010. *PISA 2009 Assessment Framework: Key Competencies in Reading, Mathematics and Science*. Ukraina: OECD Publishing. https://www.google.co.id/books/edition/PISA_2009_Assessment_Framework_Key_Compe/VRfWAgAAQBAJ?hl=id&gbpv=0.
- 11) OECD. 2016. *PISA 2018 Reading Literacy Framework*. Paris, France: OECD Publishing. <https://www.oecd.org/pisa/data/PISA-2018-draft-frameworks.pdf>.
- 12) OECD. 2017. *Youth in Transition: How Do Some of The Cohorts Participating in PISA Fare in PIAAC?*. Paris: OECD. <https://doi.org/10.1787/51479ec2-en>.
- 13) OECD. 2019a. *PISA 2018 Assessment and Analytical Framework*. Paris, France: OECD Publishing. <https://doi.org/10.1787/b25efab8-en>.
- 14) OECD. 2019b. *How does PISA Define and Measure Reading Literacy?*. Paris, France: OECD Publishing. <https://doi.org/10.1787/22260919>
- 15) OECD. 2019c. *PISA 2018 Release Field Trial and Main Survey New Reading Items*. Paris, France: OECD Publishing. https://www.oecd.org/pisa/test/PISA2018_Released_REA_Items_12112019.pdf.
- 16) OECD. 2019d. *PISA 2018 Result: What Students Know and Can Do (Volume I)*. Paris, France: OECD Publishing. https://www.google.co.id/books/edition/PISA_2018_Results_Volume_I_What_Students/smnBDWAAQBAJ?hl=id&gbpv=0.
- 17) OECD. 2019e. *PISA 2018 Result: Where All Student Can Succeed (Volume II)*. Paris, France: OECD Publishing. <https://doi.org/10.1787/b5fd1b8f-en>.
- 18) OECD. 2021. *PISA 21st-Century Readers: Developing Literacy Skills in a Digital World*". Paris, France: OECD Publishing. https://www.google.co.id/books/edition/PISA_21st_Century_Readers_Developing_Lit/fqYsEAAAQBAJ?hl=id&gbpv=0.
- 19) OECD. 2023. *PISA 2022 Results (Volume I): The State of Learning and Equity in Education*. Paris, France: OECD Publishing. https://www.google.co.id/books/edition/PISA_2022_Results_Volume_I_The_State_of/5cTnEAAAQBAJ?hl=id&gbpv=1&dq=multiple+source+text+in+pisa+assessment&pg=PA99&printsec=frontcover.
- 20) OECD. 2023. *Student Achievement in Türkiye: Findings from PISA and TIMSS International Assessments*. Great Britain: OECD. Publishing. https://www.google.co.id/books/edition/Student_Achievement_in_T%C3%BCrkiye_Findings/3s-dEAAAQBAJ?hl=id&gbpv=0.
- 21) Putrawangsa, Susilahudin., & Hasanah, Uswatun. 2018. Integrasi Teknologi Digital dalam Pembelajaran di Era Industri 4.0: Kajian dari perspektif pembelajaran matematika. *Jurnal Tatsqif*, 16,(1), 42-54. <https://doi.org/10.20414/jtq.v16i1.203>.
- 22) Putrawangsa, Susilahudin., & Syawahid, Muhammad. 2018. Model Kegiatan Microteaching untuk Mengembangkan Keterampilan Melaksanakan Pembelajaran Matematika Berpusat pada Siswa. *Jurnal Elemen*, 4,(1), 50-65. https://www.researchgate.net/profile/Susilahudin-Putrawangsa/publication/322894628_Model_Kegiatan_Microteaching_untuk_Mengembangkan_Keterampilan_Melaksanakan_Pembelajaran_Matematika_Berpusat_pada_Siswa/links/5aabe7db458515baa3b97e8f/Model-Kegiatan-Microteaching-untuk-Mengembangkan-Keterampilan-Melaksanakan-Pembelajaran-Matematika-Berpusat-pada-Siswa.pdf
- 23) Rapono, Muhammad; Safrial, Safrial; Wijaya, Candra. 2019. Urgensi Penyusunan Tes Hasil Belajar: Upaya Menemukan Formulasi Tes Yang Good dan Benar. *Jupii: Jurnal Pendidikan Ilmu-Ilmu Sosial*, 11(1), 95-104. <https://garuda.kemdikbud.go.id/documents/detail/1039652>
- 24) Sanaky, H. A. 2009. *Media Pembelajaran*. Yogyakarta, Indonesia: Safiria Insania Press.

PISA-Based Assessment Instrument In Javanese Language Learning Grade VIII

- 25) Setyowati, Linda Dwi., Hartono., Sriyanto, Ismail. 2014. Peningkatan Keterampilan Berbicara Melalui Media Flip Chart Pada Anak Kelompok A Taman Kanak-Kanak Dan Play Group Kreatif Primagama Surakarta Tahun Ajaran 2013/2014". *Kumara Cendekia*, 3(4), 358-366. <https://doi.org/10.20961/kc.v3i4.34582>.
- 26) Stufflebeam, Daniel., Shinkfield, Anthony J. 1985. *Systematic evaluation: A self-instructional guide to theory and practice*. Springer Science & Business Media, 41, USA: Kluwer Academic Publisher
- 27) Yulia, E., Riadi, S., Nursanni, B. 2023. The Validity of Interactive Multimedia on Metal Coating Learning Developed Using the ADDIE Model. *Jurnal Penelitian Pendidikan IPA*, 9(5), 3968-3974. <https://doi.org/10.29303/jppipa.v9i5.3772>.



There is an Open Access article, distributed under the term of the Creative Commons Attribution – Non Commercial 4.0 International (CC BY-NC 4.0) (<https://creativecommons.org/licenses/by-nc/4.0/>), which permits remixing, adapting and building upon the work for non-commercial use, provided the original work is properly cited.

Third-Person Passive Voice in Illustrative Explanatory Speech Acts by Residents of Sumberejo, Ambulu, Jember



Adinda Alfiranda Zahroh¹, Afendy Widayat², Ahmad Rizky Wahyudi³

^{1,2}Java Language Education Study Program Graduate Program Faculty of Languages, Arts and Culture Yogyakarta State University Jl. Colombo Yogyakarta No. 1, Sleman, Daerah Istimewa Yogyakarta 55281, Indonesia.

³Postgraduate Program in Language and Literature Education, Faculty of Language and Arts, Surabaya State University Jl. Lidah Wetan, Lidah Wetan, Kec. Lakarsantri, Kota Surabaya, Jawa Timur 60213

ABSTRACT: Third-person passive voice as one of the many topics of grammatical semantics is used to describe the relationship between the third actor and the action in the form of passive verbs in a grammatically meaningful sentence. The formulation of the problem in this study is what and how the construction of third-person passive voice in speech acts is explained illustratively by residents of Sumberejo Village, Ambulu District, Jember Regency. This descriptive qualitative research is classified as ethnographic communication research. Data collection through listening and speech techniques After the data is collected, it is then analyzed through categorical, descriptive, and distributional methods. The theory in this research is the theory of generative transformation by Chomsky (1965) and the theory of speech acts by Searle (1979). The result of the research shows that there are a total of 10 types of third person passive voice in illustrative explaining speech acts by residents of Sumberejo Village, Ambulu District, Jember Regency. The division of the topic types of third-person passive voice is based on the form of suffix and the nature of the passive verb with the type of speech act of explaining with illustrative strategies.

KEYWORDS: Third-Person Passive Voice, Speech Acts, Jember, Politeness, Generative Transformation

I. INTRODUCTION

Third-person passive voice (hereinafter referred to as TPPV) in illustrative explaining speech acts performed by residents of Sumberejo Village, Ambulu Subdistrict, Jember Regency is research of grammatical semantics as well as pragmatics. The research that focuses on the use of TPPV observes the meaning of verbs contained in a sentence unit in the form of illustrative explaining speech acts (or IESA). The meaning of TPPV contained in IESA is syntactic. Because the meaning of TPPV in the form of words in IESA gets a constructive change through the process of affixation, such as affixation or prefixation. So it can be said that the meaning of TPPV in IESA which is then presented in this study is in line with Pateda's description (2010) as grammatical meaning.

Voice according to Lyons, (1969), has a function to show the relationship between the actor and the action through the construction of passive verbs which in this study is TPPV contained in IESA. The data of this study are conversations conducted by residents of Sumberejo Village, Ambulu District, Jember Regency in the form of IESA which certainly contains DPPT. IESA is often used by Sumberejo Village, Ambulu District, Jember Regency when communicating daily. The IESA carried out by the people of Sumberejo Village, Ambulu District, Jember Regency has various purposes. As has been revealed by Tarigan (1984), IESA is used to explain a matter relating to the subject of discussion in a conversation. Because it involves the degree of speakers and speech partners at the time of interaction, it is necessary to understand that IESA is one of the speech acts that prioritize respect with the interlocutor. This is because there is a group of people who need to be respected, as well as other groups of people who can be invited to interact simply (Poedjasoedarmo, 1979). The procedures that can be carried out by a person to respect interlocutors are in line with their respective social contexts. As well as groups that have differences in rank, degree, and position in society, will use various methods (Anwar, 1995). Austin (in Ibrahim, 1993) also strengthens this opinion by explaining that speech acts are carried out based on self-interest to show what kind of position the speaker has towards certain groups. Therefore, IESA in this study is related to politeness theory which deals with social relations, social structures, and social situations. The social context attached to the speaker as the perpetrator of IESA should contain certain meanings and intentions. This kind of thing has previously

Third-Person Passive Voice in Illustrative Explanatory Speech Acts by Residents of Sumberejo, Ambulu, Jember

been discussed by Searle (in Nadar, 2009), that how to interpret an utterance depends on the conditions in the context. In the 1980s, Levinson and Brown put forward a theory of politeness in their book "Politeness" which combines the opinions of Seale and Austin. According to Levinson and Brown (1987), speech acts affect (1) social distance (distance rating); (2) the social status of speakers and speakers (power rating); and (3) the degree of imposition (rank rating). With these influences, social relations, social structures, and social situations can affect speakers when performing IESA. This research is described using Levinson and Brown's politeness theory to examine IESA containing TPPV in conversations conducted by residents of Sumberejo Village, Ambulu District, Jember Regency. The supporting theory in this study is the theory of generative transformation by Avram Noam Chomsky (1965). This theory has three core paradigms, namely: (1) the existence of syntactic constructs that have to do with speech or sentences. The characteristics of speech can then be perceived using sensing which is included as a surface structure (outer structure); (2) in the deep structure (inner structure), there are semantic relations and systemic relations, and (3) based on the inner structure, then the inner structure is explained based on the syntactic tri aspect in the form of categories, functions, and roles. Departing from the syntactic tri-aspect relation, it can be understood that the grammatical semantic meaning in TPPV in a sentence is in the form of IESA. To the explanation above, the research explores TPPV in IESA in conversations conducted by residents of Sumberejo Village, Ambulu District, Jember Regency. Further discussion in this research is complemented by three approaches, namely relational, dimensional, and theoretical.

II. METHOD

This study examines the use of TPPV in IESA found in the conversations of residents of Sumberejo Village, Ambulu Sub-district, Jember Regency. Since the conversation is classified as communicative action, communication ethnography is used in this research (Hymes in Ibrahim, 1994). The data taken for this research are sentences quoted directly from the conversations of residents of Sumberejo Village, Ambulu Subdistrict, Jember Regency daily in the form of IESA which contains TPPV. The data collection methods in this research are the speech method and the listening method (Sudaryanto, 1993). The speech method in this study was carried out through interviews with sources to explore information related to the social context. Meanwhile, the listening method in this research is classified into five: the listening method with speaking, listening method without speaking, tapping method, recording method, and recording method. The data that has been collected is then validated first before being selected and sorted in line with the context of the data attached to the speakers and speech partners. The data was then processed using categorical, descriptive, and distributional methods. Sudaryanto (1993) says that the categorical method is used to group the data according to the main concept. Then the descriptive method is used to present an explanation of the data. The distributional method is used to classify the types of IESA based on its strategy and TPPV according to its suffix structure and verb character.

III. RESULT AND DISCUSSION

As explained by Keraf (1981), the illustrative strategy in the act of explaining is done by giving examples or parables related to something that is explained. The strategy of explaining the results and discussion is crossed with third-person passive voice which consists of three types. The three types are third-person passive voice without suffix, third-person passive voice with the suffix */-i/*, and third-person passive voice with the suffix */-ke/*. Further information is as follows.

A. Patientive TPPV without Suffix in IESA

- (1) S: *Kucing putih iku isuk-isuk nek gurun dipakani sega anget ya tetep ngglibet ae neng sikil, sampek tau winginane iku ngeyang-ngeyong ae neng sikilku aku masak, sampek risih kucing putih iku. Takgetak pancet gak ngalih. Taktapak ya sik mbalik maneh ngglibet. Masiya kucing putih iku ditapak koyok apa ae gak bakal ngalih nek gurun dipakani sega anget. Pancen anyi-anyi nek mangan, dipakani sega adhem gak gelem.*

'That white cat, if it hasn't been given warm rice in the morning, just keeps rubbing against my legs. Yesterday, it kept meowing at my feet while I was cooking, and it got to the point where I felt annoyed. Even when I tried to shooit away, it wouldn't leave. I tapped it, but it returned and kept rubbing against me. Unless the white cat gets warm rice, it won't go away. So picky about food—it won't even eat cold rice.'

Data (1) was taken from a conversation between a female adult speaker with high socioeconomic status and a high level of religiosity, and a teenage male interlocutor with low socioeconomic status and a moderate level of religiosity. The informal conversation was conducted between two family members, and the speaker was the mother of the interlocutor. Because the speaker is the interlocutor's mother, she used the Ngoko variety of Javanese. At that time, the speaker told the interlocutor about her pet cat, describing how it always asked for warm rice and fish in the morning. The cat would keep bothering the speaker if its wish wasn't fulfilled. Even if hit, the cat wouldn't move away from the speaker. The speaker's utterance is appropriately called IESA because there is the word *koyok* 'like' in the underlined sentence. In this utterance, the speaker describes her attempt

Third-Person Passive Voice in Illustrative Explanatory Speech Acts by Residents of Sumberejo, Ambulu, Jember

to hit the cat, with the comparison drawn toward her pet. The underlined sentence also contains a patientive TPPV without a suffix; here is the detail of categories, functions, and roles.

	<u><i>kucing putih iku</i></u>	<u><i>ditapuk</i></u>	<u><i>koyok apa ae</i></u>	<u><i>gak bakal ngalih</i></u>	<u><i>nek</i></u>	<u><i>gurung dipakani</i></u>	<u><i>sega anget</i></u>
Category :	Nominal Phrase	Verb	Adverbial Phrase	Verbal Phrase	Adverbial Phrase		Noun
Function :	Subject	Verb			Adverb		
Role :	Patient	Patientive TPPV without Suffix			Condition		

The sentence indicates the presence of the nominal phrase *kucing putih iku* which functions as the subject and holds the role of the patient. That nominal phrase occupies the subject function because it can answer the question: what was hit? Thus, that nominal phrase qualifies as the subject of the sentence. The word *ditapuk* is identified as a verb, as it would remain grammatical if preceded by the word *ora* 'not'. Meanwhile, the function of *ditapuk* is as a verb and serves as a patientive TPPV without a suffix. That verb is classified as a TPPV without a Suffix because it originates from the base form of the pre-categorial verb *tapuk* 'to hit' with the prefix /di-/ and no suffix. Additionally, the verb in the underlined sentence in data (1) demonstrates a patientive quality. Here is the proof.

- (1) *Kucing putih iku ditapuk koyok apa ae gak bakal ngalih nek gurung dipakani sega anget*
 (1a) *Kucing putih iku dadi sasaran tapukane koyok apa ae gak bakal ngalih nek gurung dipakani sega anget*

In sentence (1), the nominal phrase *kucing putih iku* is neither the speaker nor the listener. Furthermore, this nominal phrase is referred to as the patient because it is the target of the action described in the sentence. This can be proven by examining the word *ditapuk* in sentence (1). The word *ditapuk* functions as a patientive TPPV without a suffix. The passive patientive nature of this verb can be demonstrated by transforming *ditapuk* using the formula: *dadi sasaran* /pre-categorial/+- an/+-e/ (becomes the target of /pre-categorial/+-an/+-e/). This transformation produces the phrase *dadi sasaran tapukane* (becomes the target of someone hit) in the sentence (1a) as the modified form of sentence (1). In this way, it can be understood that the verb *ditapuk* in the sentence (1) represents a patientive TPPV without a suffix, indicating the speaker's action directed toward the patient *kucing putih iku* as its target.

B. Resultative TPPV without Suffix in IESA

- (2) S: *Ya kenek ae nek pengin nggawe daging kebo kanggo masakan rendhang. Prosese gak ribet. Aku ya wis tau ngolah daging kebo dadi rendhang. Bagiyan daging kebone direndhang koyok daging sapi umume. Sing dipilih daginge sing atos. Ben gak ajur pas dimasak suwe. Biyasane sing dinggo rendhang iku bagiyan paha belakang atas. Awakmunganggo daging belakang luar ya isok.*
 'Yes, it's fine if you want to use buffalo meat to make rendang. The process isn't complicated. I've also tried cooking buffalo meat as rendang before. The buffalo meat is prepared as rendang, just like beef usually is. The chosen part is tough meat so it doesn't fall apart during long cooking. Usually, the part used for rendang is the upper hind leg. You can also use the outer back part.'

Data (2) was taken from a conversation conducted by a female teenage speaker with a moderate socioeconomic status and a moderate level of religiosity, and a teenage female interlocutor with a low socioeconomic status and a low level of religiosity. The informal conversation took place between two neighbors. Since they are of the same age, the speaker used the Ngoko variety of Javanese. At that time, the speaker was explaining to the interlocutor about buffalo meat used as the ingredient for rendang. The part of the buffalo meat used for rendang is the tough part, such as the upper thigh. The selection of the tough part of the buffalo is to ensure it can withstand long boiling. The utterance made by the speaker is appropriately called IESA because there is the word *koyok* 'like' in the underlined sentence. In this utterance, the speaker describes buffalo meat prepared as rendang, similar to how beef is usually prepared. Furthermore, the underlined sentence also contains a resultative TPPV without a suffix; here are the detail of categories, functions, and roles.

	<u><i>Bagiyan daging kebone</i></u>	<u><i>direndhang</i></u>	<u><i>koyok daging sapi umume</i></u>
Category :	Nominal Phrase	Verb	Adverbial Phrase
Function :	Subject	Verb	Adverb
Role :	Source	Patientive TPPV without Suffix	Condition

Third-Person Passive Voice in Illustrative Explanatory Speech Acts by Residents of Sumberejo, Ambulu, Jember

The sentence indicates the presence of the nominal phrase *Bagiyan daging kebone* ‘part of the buffalo meat’ which functions as the subject and has the role of source. This nominal phrase occupies the subject function because it can answer the question: what is made into *rendang*? Thus, this nominal phrase qualifies as the subject of the sentence. The word *direndhang* ‘is made into *rendang*’ is identified as a verb because it would remain grammatical if preceded by the word *ora* ‘not’. The function of this verb is as a verb and serves as a resultative TPPV without a suffix. This verb is classified as TPPV without a suffix because it originates from the base noun *rendhang* ‘*rendang*’ with the prefix /di-/ and no suffix. Additionally, the verb in the underlined sentence in data (2) demonstrates a patientive quality. Here is the proof.

- (2) *Bagiyan daging kebone direndhang koyok daging sapi.*
 (2a) *Bagiyan daging kebone didadekake rendhang koyok daging sapi.*

In sentence number 2, the nominal phrase *Bagiyan daging kebone* ‘part of the buffalo meat’ is neither the speaker nor the listener. Furthermore, this nominal phrase is referred to as the source because it serves as the material for the action described in the sentence. This can be proven by examining the word *direndhang* ‘is made into *rendang*’ in the sentence (2). The word *direndhang* functions as a resultative TPPV without a suffix. The passive resultative nature of this verb can be demonstrated by transforming the word using the formula: *didadekake* Noun ‘made into Noun’. This transformation produces the phrase *didadekake rendhang* ‘made into *rendang*’ in the sentence (2a) as the modified form of sentence (2). Thus, it can be understood that the verb *direndhang* in the sentence (2) represents a resultative TPPV without a suffix, indicating the speaker's action that makes *Bagiyan daging kebone* the material for something referred to as *rendang* in that sentence.

C. Instrumental TPPV without Suffix in IESA

- (3) S: *Sawise ladinge diungkal bakal mundhak koyok pedhang, lincip terus meling landhep. Nah iku ladinge cocog mbokgawe mbeleh pitik. Ngungkale diitung ping sepuluh. Pas ngungkal, kudu dipaerhatekna, tangan kudu nenet bageyan wesine lading. Iku ngono ben bageyan kethule isok kenek ungal. Terus nek pengin lading iku gak ucul pas diungkal, nganggoa lap. Andhuk ya isok.*

‘After the knife is sharpened, it will become like a sword, sharp and pointed. This knife is suitable for slaughtering chickens. The sharpening should be done ten times. While sharpening, it’s important to note that your hand should press on the edge of the knife’s blade. This ensures that the sharp part is properly sharpened. If you want to keep the knife from slipping while sharpening, use a cloth. A towel works as well.’

Data (3) was taken from a conversation conducted by an adult male speaker with high socioeconomic status and a high level of religiosity, and a teenage male interlocutor with low socioeconomic status and a low level of religiosity. The informal conversation was held between two family members, with the speaker being the interlocutor’s uncle. Thus, the speaker used the Ngoko variety of Javanese. At that time, the speaker was explaining to the interlocutor how to sharpen a knife. One important aspect of knife sharpening is that the blade should be pressed carefully to sharpen the dull part well. It is advisable to use a cloth for grip while sharpening. The speaker’s utterance is appropriately called IESA because it includes the word *koyok* ‘like’ in the underlined sentence. In this utterance, the speaker describes that a knife sharpened in this way will have a sharpness similar to that of a sword. Furthermore, the underlined sentence also contains an instrumental TPPV without a suffix; here are the detail of categories, functions, and roles.

		<u><i>ladinge</i></u>	<u><i>diungkal</i></u>	<u><i>bakal mundhak koyok pedhang</i></u>
Category	:	Noun	Verb	Adverbial Phrase
Function	:	Subject	Verb	Adverb
Role	:	Patient	Instrumental TPPV without Suffix	Khn

The sentence indicates the presence of the noun *ladinge* ‘the knife’, which functions as the subject and has the role of a patient. This noun occupies the subject function because it can answer the question: what is sharpened using the sharpener? Thus, this noun qualifies as the subject of the sentence. The word *diungkal* ‘is sharpened’ is identified as a verb because it remains grammatical when preceded by the word *ora* ‘not’. The function of this verb is as a verb, serving as an instrumental TPPV without a suffix. This verb is classified as TPPV without a suffix because it originates from the base noun *ungkal* ‘sharpener’ with the prefix /di-/ and no suffix. Additionally, the verb in the underlined sentence in data (3) demonstrates an instrumental quality. Here is the proof.

- (3) *Ladinge diungkal bakal mundhak koyok pedhang.*

Third-Person Passive Voice in Illustrative Explanatory Speech Acts by Residents of Sumberejo, Ambulu, Jember

(3a) *Ladinge dadi sasaran untkale bakal mundhak koyok pedhang.*

In sentence number 3, noun ***ladinge*** is neither a speaker nor a speaker. In addition, the noun is also called a patient because he is the target of the actions contained in the sentence. This can be proven by observing the word ***diungkal*** in the sentence (3). The word ***diungkal*** has a role as an instrumental TPPV without a suffix. The nature of the passive instrumental verb attached to the word can be proven by changing the word using the formula: *to be the target of Noun+/-e/ 'tobe targeted by Noun+/-e/ Noun'*. In this way, the phrase 'made the target of the sharpening' in sentence (3a) is produced due to changing from the sentence (3). Thus, it can be understood that the verb ***diungkal*** in the sentence (3) is an instrumental TPPV without a suffix which indicates the speaker's act of the sharpening tool aimed at ***ladinge*** as the target in the sentence.

D. Repetitive TPPV with Suffix (-i) in IESA

(4) S: *Terus wingi maneh enek Lik Di, takrungok-rungokne dheke ya sambat merga satemu. ***Daging-daginge disunduki koyok upil*** iku ngono ya mesthi gak maregi ta nek dipangan. Nah mangkane sadurunge ngirisi daging, perlu ndeloksepira ukurane daging sing diiris. Ben gak salah. Uduk merga ben satene akeh, terus sundukane cilik-cilik. Sing penting daginge iku ojok cilik-cilik! Supaya gak ngentek-ngenteki sunduke sisan.*

'Then yesterday, there was also Uncle Di, and I heard he was complaining about his satay. The meat was skewered into tiny pieces like little bits, so of course, it wasn't satisfying to eat. That's why, before cutting the meat, you need to look at how big the pieces are. So you don't make a mistake. It's not about making more satay by cutting them small. What matters is that the pieces aren't too small! So it doesn't waste the skewers either.'

Data (4) is taken from conversations conducted by speakers and partners. Both are male, adolescent, have low socioeconomic status, and have a low level of faith. The informal conversation was carried out by two people who are family-related. More precisely, the speaker is a cousin of the partner. Because the speakers are cousins of the partners and they are the same age, the language used by the speakers is the Javanese variety Ngoko. At that time, the speaker was telling the partner about his experience. It is said that one day, there was a celebration at the speaker's uncle's house. At that time, the partner was given the task of covering satai with a small size. Therefore, a person who eats satai is not full. The speech delivered by the speaker deserves to be called IESA through illustrations because there is a tearing word 'like' in a slashed sentence. In the speech, the speaker described the size of the satai meat that was eaten by the partner like nasal discharge. Then the slashed sentence also contains Repetitive TPPV with the suffix /-i/, here are the details of its categories, functions, and roles.

	<i>daging-daginge</i>	<i>disunduki</i>	<i>koyok upil</i>
Category	: Nominal phrase	Verb	Adverbial Phrase
Function	: Subject	Verb	Adverb
Role	: Patient	Repetitive TPPV with Suffix (-i)	Khn

The sentence indicates the presence of the nominal phrase ***Daging-daginge*** which functions as the subject and holds the role of the patient. That nominal phrase occupies the subject function because it can answer the question: what was stabbed? Thus, that nominal phrase qualifies as the subject of the sentence. The word ***disunduki*** is identified as a verb, as it would remain grammatical if preceded by the word ***ora*** 'not'. Meanwhile, the function of ***disunduki*** is as a verb and serves as a locative TPPV with a suffix (-i). That verb is classified as a TPPV with suffix (-i) because it originates from the base form of the noun ***sunduk*** 'stab' with the prefix /di-/ and suffix (-i). Additionally, the verb in the underlined sentence in data (4) demonstrates a repetitive quality. Here is the proof.

(4) *Daging-daginge disunduki koyok upil*

(4a) *Daging-daginge bola-bali dadi sasaran sundukane koyok upil*

In sentence (4), the nominal phrase ***Daging-daginge*** is neither the speaker nor the listener. Furthermore, this nominal phrase is referred to as the patient because it is the target of the action described in the sentence. This can be proven by examining the word ***disunduki*** in sentence (4). The word ***disunduki*** functions as a repetitive TPPV with suffix (-i). The passive repetitive nature of this verb can be demonstrated by transforming ***disunduki*** using the formula: *bola-bali dadi sasaran /Noun+/-an+/-e/ (frequently becomes the target of /Noun+/-an+/-e/)*. This transformation produces the phrase ***dadi sasaran sundukane*** (becomes the target of someone stabbed) in the sentence (4a) as the modified form of sentence (4). In this way, it can be understood that the verb ***disunduki*** in the sentence (4) represents a repetitive TPPV with suffix (-i), indicating the speaker's

Third-Person Passive Voice in Illustrative Explanatory Speech Acts by Residents of Sumberejo, Ambulu, Jember

action directed toward the patient *Daging-daginge* as its target frequently.

E. Locative TPPV with Suffix (-i) in IESA

- (5) S: *Seminggu kamare dienggoni Dowi, langsung malih koyok gedhogan jaran. Gak onok sing ngresiki. Jan gak kerumat ngono kondisine Dowi. Aris sing saomah karo Dowi paling ya gur ngekeki panganan thok, gak nambakne, apa maneh digawa nang dhokter. Pancen umure wis tuwek, paling Aris mikire percuma ditambani. Tapi kudune mbok ya sing mbeneh karo ome. Mosok nek ngopeni koyok ngono?*

'In just a week of Dowi staying in the room, it turned into a mess, like a stable. No one cleaned it. Clearly, Dowi was not cared for properly. Aris, who lives with Dowi, probably just gave him food without doing anything more—certainly not taking him to the doctor. True, Dowi is already old, and Aris may think it's pointless to treat him. But shouldn't he take better care of his uncle? Is this really the proper way to care for someone?'

Data (5) is taken from a conversation between an adult male speaker with high socioeconomic status and a high level of faith, and a teenage male interlocutor with low socioeconomic status and a lower level of faith. This informal conversation took place between two family members. Specifically, the speaker is the interlocutor's uncle. Because the speaker is the interlocutor's uncle, he uses Javanese in the Ngoko register. At that time, the speaker was telling their interlocutor about a person named Dowi. Dowi is the speaker's neighbor who suffers from a mental disorder. Dowi is supported by his sibling, Aris. However, Aris is not diligent in caring for Dowi. The speaker even mentioned that Aris never cleans Dowi's place of residence—it's like a horse stable. The speaker's statement can be classified as IESA through illustration because it contains the word *koyok* "like" in the italicized sentence. In this statement, the speaker describes Dowi's room as similar to a horse stable. Additionally, the italicized sentence contains locative TPPV with the suffix /-i/; here are the details of its categories, functions, and roles.

	<i>Seminggu</i>	<i>kamare</i>	<i>dienggoni</i>	<i>Dowi</i>	<i>langsung malih koyok gedhogan jaran</i>
Category	: Noun	Noun	Verb	Pronoun	Adverbial Phrase
Function	: Adverb	Subject	Verb	Object	Adverb
Role	: Time	Location	Locative TPPV with Suffix (-i)	Person	Condition

The sentence indicates the presence of the nominal phrase *kamare* which functions as the subject and holds the role of the location. That nominal phrase occupies the subject function because it can answer the question: what was occupied? Thus, that nominal phrase qualifies as the subject of the sentence. The word *dienggoni* is identified as a verb, as it would remain grammatical if preceded by the word *ora* 'not'. Meanwhile, the function of *dienggoni* is as a verb and serves as a locative TPPV with a suffix (-i). That verb is classified as a TPPV with suffix (-i) because it originates from the base form of the pre-categorial verb *enggon* 'occupy' with the prefix /di-/ and suffix (-i). Additionally, the verb in the underlined sentence in data (5) demonstrates a locative quality. Here is the proof.

- (5) *Seminggu kamare dienggoni Dowi, langsung malih koyok gedhogan jaran.*
 (5a) *Seminggu kamare dadi papan enggonane Dowi, langsung malih koyok gedhogan jaran.*

In sentence (5), the noun *kamare* is neither the speaker nor the listener. Furthermore, this noun is referred to as the location because it is the location of the action described in the sentence. This can be proven by examining the word *dienggoni* in sentence (5). The word *dienggoni* functions as a locative TPPV with suffix (-i). The passive locative nature of this verb can be demonstrated by transforming *dienggoni* using the formula: *dadi papan* /pre-categorial/+/an/+/e/ (become the place of /pre-categorial/+/an/+/e/). This transformation produces the phrase *dadi papan enggonane* (becomes the place of someone occupied) in the sentence (5a) as the modified form of sentence (5). In this way, it can be understood that the verb *dienggoni* in the sentence (5) represents a locative TPPV with suffix (-i), indicating the action of the speaker who made *kamare* the location of the action.

F. Receptive TPPV with Suffix (-i) in IESA

- (6) S: *Beh nelangsa aku mbek Deni. Wis enek seminggu kucing kesayangane gak mulih. Ngerti awakmu? Kucinge sing nggunthil iku jan diistimewakne. Pas gering, kucinge diobati koyok ngobati wong, sesuai kendhalane. Nek panas, ya dikei obat penurun nafsu makan, nek mencret dikei obat diare. Obate lengkap teka dhokter hewan. Mangane ya enak-enak, sentrat. Padahal kucinge iku gak sepira apik. Gur alus ulune, rase uduk anggora utawa persia.*

Third-Person Passive Voice in Illustrative Explanatory Speech Acts by Residents of Sumberejo, Ambulu, Jember

'I feel so sad for Deni. It's been a week, and his beloved cat hasn't come home. Do you know? His youngest cat is truly treated with great care. When it's sick, he treats it like treating a person, matching its symptoms. If it has a fever, he gives it fever medicine; if it has diarrhea, he gives it diarrhea medicine. A veterinarian prescribes all the medication. Its meals are also delicious and special. And yet, the cat itself isn't all that special—just soft fur, but it's neither an Angora nor a Persian.'

Data (6) is taken from a conversation between an adult male speaker with moderate socioeconomic status and a moderate level of faith, and a teenage male interlocutor with low socioeconomic status and a low level of faith. This informal conversation took place between two family members. Specifically, the speaker is the interlocutor's uncle. Because the speaker is the interlocutor's uncle, he uses Javanese in the Ngoko register. At that time, the speaker was telling the interlocutor about Deni's cat, which was currently missing. Although not remarkable, the cat was deeply loved by Deni. According to the speaker, when it was sick, Deni would take the cat to the vet and give it medicine with care. Deni cared for the cat with affection as if caring for a person. This statement can be classified as IESA through illustration because it contains the word *koyok* "like" in the italicized sentence. In this statement, the speaker describes Deni's care for the cat as similar to the care given to a person. Additionally, the italicized sentence contains a receptive TPPV with the suffix *-i*; here are the details of its categories, functions, and roles.

		<u><i>kucinge</i></u>	<u><i>diobati</i></u>	<u><i>koyok ngobati wong</i></u>
Category	:	Noun	Verb	Adverbial Phrase
Function	:	Subject	Verb	Adverb
Role	:	Receiver	Receptive TPPV with Suffix (-i)	Condition

The sentence indicates the presence of noun *kucinge* which functions as the subject and holds the role of the receiver. That nominal phrase occupies the subject function because it can answer the question: what was treated? Thus, that noun qualifies as the subject of the sentence. The word *diobati* is identified as a verb, as it would remain grammatical if preceded by the word *ora* 'not'. Meanwhile, the function of *diobati* is as a verb and serves as a receptive TPPV with a suffix (-i). That verb is classified as a TPPV with suffix (-i) because it originates from the base form of the noun *obat* 'medicine' with the prefix /di-/ and suffix (-i). Additionally, the verb in the underlined sentence in data (6) demonstrates a receptive quality. Here is the proof.

- (6) *Kucinge diobati koyok ngobati wong.*
 (6a) *Kucinge diwenehi obat koyok ngobati wong.*

In sentence (6), the noun *kucinge* is neither the speaker nor the listener. Furthermore, this noun is referred to as the receiver because it is receiver of something from the action described in the sentence. This can be proven by examining the word *diobati* in sentence (6). The word *diobati* functions as a locative TPPV with suffix (-i). The passive receptive nature of this verb can be demonstrated by transforming *diobati* using the formula: *diwenehi* /Noun/ (is given /Noun/). This transformation produces the phrase *diwenehi obat* (is given medicine by someone) in the sentence (6a) as the modified form of sentence (6). In this way, it can be understood that the verb *diobati* in the sentence (6) represents a receptive TPPV with suffix (-i), indicating the action of someone who gives *obat* to *kucinge*.

G. Causative TPPV with Suffix (-i) in IESA

- (7) S: *Hlah ya Beni iku kok betah men mangan pedhes. Ngono iku apa ya isok menikmati rasane panganan nek pedhes gak aturan? Meh ben dina aku meruhi arek iku tuku seblak neng sebelah omahe Bu Karti. Gek pedhese eram. Iku masiya seblake dipedhesi koyok racun mbek bakule, tetep gak bakal ngaruh neng ilate Beni. Aku kapanane kae ya sampek isin pas mbakso karo arek iku. Mosok ta sambel sawadhah dientekne. Jan dadi sawang-sawangan wong pas iku. Pancen arek gak isok ngrasakne pedhes.*
 'That's why Beni is so comfortable eating spicy food. Can he even taste the real flavor if it's always ridiculously spicy? Almost every day, I see him buying seblak from the stall near Bu Karti's house. The spiciness is just extreme! Even if the seller makes the seblak as spicy as poison, it still won't affect Beni's taste buds. Just the other day, I felt so embarrassed when we went for meatballs together. He actually finished a whole bowl of chili sauce! People were staring at us. This kid really can't seem to feel the spiciness.'

Data (7) is taken from a conversation between the speaker and her friend, both of whom are female teenagers, of low socioeconomic status, and with a low level of religious observance. This informal conversation took place between two people

Third-Person Passive Voice in Illustrative Explanatory Speech Acts by Residents of Sumberejo, Ambulu, Jember

who are close neighbors. Because they are the same age, the language used by the speakers is Javanese variety Ngoko. At that time, the speaker was telling a friend about a person named Beni. According to the speaker, Beni is someone who doesn't easily feel the heat when eating spicy food. For example, even when eating *seblak* with a lot of spices, he doesn't get overwhelmed by the spiciness. The speaker also wonders about Beni's condition, questioning whether he can truly taste the food if he keeps eating like that. On another occasion, the speaker admitted feeling embarrassed when they ate meatballs together, as Beni finished all the chili sauce provided by the seller. The speaker's statement can be classified as IESA through illustration because it contains the word *koyok* "like" in the italicized sentence. In this statement, the speaker describes the *seblak* made spicy by Beni as being like poison. Additionally, the italicized sentence contains causative TPPV with the suffix /-i/; here are the details of its categories, functions, and roles.

		<u><i>Seblake</i></u>	<u><i>dipedhesi</i></u>	<u><i>koyok racun</i></u>
Category	:	Noun	Verb	Adverbial Phrase
Function	:	Subject	Verb	Adverb
Role	:	Experiencer	Causative TPPV with Suffix (-i)	Condition

The sentence indicates the presence of noun *Seblake* which functions as the subject and holds the role of the experiencer. That noun occupies the subject function because it can answer the question: what enhances the spiciness? Thus, that noun qualifies as the subject of the sentence. The word *dipedhesi* is identified as a verb, as it would remain grammatical if preceded by the word *ora* 'not'. Meanwhile, the function of *dipedhesi* is as a verb and serves as a causative TPPV with a suffix (-i). That verb is classified as a TPPV with suffix (-i) because it originates from the base form of the adjective *pedhes* 'occupy' with the prefix /di- / and suffix (-i). Additionally, the verb in the underlined sentence in data (7) demonstrates a causative quality. Here is the proof.

- (7) *Seblake dipedhesi koyok racun.*
 (7a) *Seblake didadekake pedhes koyok racun.*

In sentence (7), the noun *Seblake* is neither the speaker nor the listener. Furthermore, this nominal phrase is referred to as the experiencer because it experienced the state described in the sentence. This can be proven by examining the word *dipedhesi* in sentence (7). The word *dipedhesi* functions as a causative TPPV with suffix (-i). The passive causative nature of this verb can be demonstrated by transforming *dipedhesi* using the formula: *didadekake* /adjective/ (made /adjective/). This transformation produces the phrase *didadekake pedhes* (made spicy) in the sentence (7a) as the modified form of sentence (7). In this way, it can be understood that the verb *dipedhesi* in the sentence (7) represents a causative TPPV with suffix (-i), indicating actions taken by someone that change the condition of someone experiencing *seblake* becomes spicy.

H. Causative TPPV with Suffix (-ke) in IESA

- (8) S: *Ndelok wong tuweke Made ngono, aku jane rodok ngelus dhadha. Hla piye? Jenenge anak ate nglanjutne sekolah, malah dipenging. Jarene mendhing kerja ae. Padahal Made iku areke ya patheng, ya seneng sinau, maca buku. Ya mesthi ae ta, nek Made kuwi ketara mbetah-betahne. Artine, dheke isoke gur manut thok, masiya gak' memperkirakan dampak' eleke 'perlakuane' iku. **Ben gak koyok wong sing 'buta keadaan', wong tuweke Madekudu dipahamne.** Dadi gak sokur manut thok dadi anak. Manut iku enek batasane. Lek soal pilihan sing menyangkut pribadine anak ngene, ya kudu digawe mandiri.*

'Seeing Made's parents like that makes me feel disheartened. How could they do that? Their child wants to continue her studies, yet they forbid it. They say it's better for her just to work instead. But Made is a diligent girl, she loves studying and reading books. Naturally, Made tries her best to obey them. It means she only follows along, without considering the potential negative consequences of her actions. To avoid being unaware of the situation, Made's parents need to be made to understand. A child shouldn't just obediently follow without limits. Obedience has its boundaries. When it comes to choices related to the child's identity like this, they need to be given freedom.'

Data (8) is taken from a conversation between an adult female speaker of high socioeconomic status and strong religious commitment, and her conversational partner, a teenage male of low socioeconomic status and low level of religious observance. This informal conversation took place between two distant neighbors. More specifically, the speaker is a neighbor of the person mentioned in the conversation by the name "Made." Because the speaker is older, the conversation is conducted in Javanese, using the Ngoko register. At that time, the speaker was telling her conversational partner about a person named Made, who is also a friend of the conversational partner. The speaker feels that Made is very obedient to all of her parent's wishes, including when it comes to school. Made's parents forbid her from continuing her education, preferring that she work instead. However,

Third-Person Passive Voice in Illustrative Explanatory Speech Acts by Residents of Sumberejo, Ambulu, Jember

in reality, Made is a diligent student, meaning that she deserves to continue her studies. This reality is then conveyed by the speaker to her conversational partner. The utterance delivered by the speaker can be classified as an IESA because it contains the word *koyok* 'like' in the italicized sentence. The speaker describes Made's parents as being like people unaware of the situation if they are not made to understand. Additionally, the italicized sentence contains a causative TPPV with the suffix /-ke/; here are the details of its categories, functions, and roles.

	<u><i>Ben gak koyok wong sing buta keadaan</i></u>	<u><i>wong tuweke Made</i></u>	<u><i>kudu dipahamne</i></u>
Category	: Adverbial Phrase	Nominal Phrase	Verbal Phrase
Function	: Adverb	Subject	Verb
Role	: Condition	Experiencer	Causative TPPV with Suffix (-i)

The sentence indicates the presence of the nominal phrase *wong tuwane Made* which functions as the subject and holds the role of the experiencer. That nominal phrase occupies the subject function because it can answer the question: who is made to understand? Thus, that nominal phrase qualifies as the subject of the sentence. The verbal phrase *kudu dipahamne* is identified as a verb, as it would remain grammatical if preceded by the word *ora* 'not'. Meanwhile, the function of *kudu dipahamne* is as a verb and serves as a causative TPPV with a suffix (-ke). That verb is classified as a TPPV with suffix (-ke) because it originates from the base form of the verb *paham* 'understand' with the prefix /di-/ and suffix (-ne). Additionally, the verb in the underlined sentence in data (8) demonstrates a causative quality. Here is the proof.

- (8) *Ben gak koyok wong sing 'buta keadaan', wong tuweke Made kudu dipahamne.*
 (8a) *Ben gak koyok wong sing 'buta keadaan', wong tuweke Made kudu didadekake paham.*

In sentence (8), the nominal phrase *wong tuweke Made* is neither the speaker nor the listener. Furthermore, this nominal phrase is referred to as the experiencer because it experienced the state described in the sentence. This can be proven by examining the word *dipahamne* in sentence (8). The word *dipahamne* functions as a causative TPPV with suffix (-ke). The passive causative nature of this verb can be demonstrated by transforming *dipahamne* using the formula: *didadekake /verb/ (made /verb/)*. This transformation produces the phrase *didadekake paham* (made to understand) in the sentence (8a) as the modified form of sentence (8). In this way, it can be understood that the verb *dipahamne* in the sentence (8) represents a causative TPPV with suffix (-ke), indicating actions taken by someone that change the condition of someone experiencing *wong tuweke Made* becomes understood.

I. Patientive TPPV with Suffix (-ke) in IESA

- (9) S: *Masiya lahan sing amba iku didadekne parkirane paribasan ambane bandara, tetep gak bakal amot nek gak dipisah antarane mobil karo motor koyok ngene iki. Gek parkirane iku campur-campur antarane mobil, pedhah montor, treg ya neng kono sisan. Gak onok koordinasi blas antarane panitiane. Dadi ya ketara amburadul ngene parkirane. Sembarang kendaraan mlebu. Kabeh dikarcisi. Sip tenan wis.*
 'Even if this large space is turned into a parking lot as spacious as an airport, it still won't fit if cars and motorcycles aren't separated like this. The parking lot is a complete mix of cars, motorcycles, and even trucks there. The organizers didn't communicate at all. So, of course, the parking area is a mess like this. Every vehicle is let in. They all get ticketed. Truly well-organized, isn't it?'

Data (9) is taken from a conversation between a speaker and a conversational partner, both male teenagers, of low socioeconomic status and low religious observance. This informal conversation took place between two acquaintances. More specifically, the speaker is a casual hangout friend of the conversational partner. Because they are the same age, the conversation is conducted in Javanese using the Ngoko (informal) register. At that time, the speaker, who was on parking duty at an event held at Masjid Al-Huda, told the conversational partner that the Sumberejo field would not be big enough to accommodate parking for the event. This was because the number of attendees exceeded the capacity of the field, and those attending were not only bringing motorcycles but also cars and other large vehicles. According to the speaker, every vehicle entering the field caused issues due to the lack of coordination among the event organizers. The speaker's statement can be classified as an IESA because it contains the word *paribasan* in the italicized sentence. The speaker illustrates that even a parking area as large as an airport would not be enough if used as parking for this event. Additionally, the italicized sentence contains a patientive TPPV with the suffix /-ke/; here are the details of its categories, functions, and roles.

Third-Person Passive Voice in Illustrative Explanatory Speech Acts by Residents of Sumberejo, Ambulu, Jember

	<u>lahan sing amba iku</u>	<u>didadekne</u>	<u>parkiran</u>	<u>paribasan ambane bandara</u>
Category	Nominal Phrase	Verb	Noun	Adverbial Phrase
Function	Subject	Verb	Complement	Adverb
Role	Patient	Patientive TPPV with Suffix (-ke)	Location	Condition

The sentence indicates the presence of the nominal phrase *lahan sing amba iku* which functions as the subject and holds the role of the patient. That nominal phrase occupies the subject function because it can answer the question: what was made? Thus, that nominal phrase qualifies as the subject of the sentence. The word *didadekne* is identified as a verb, as it would remain grammatical if preceded by the word *ora* 'not'. Meanwhile, the function of *didadekne* is as a verb and serves as a patientive TPPV with a suffix (-ke). That verb is classified as a TPPV with a suffix (-ke) because it originates from the base form of the pre-categorial verb *dadi* 'to make' with the prefix /di-/ and suffix (-ne). Additionally, the verb in the underlined sentence in data (9) demonstrates a patientive quality. Here is the proof.

(9) *Lahan sing amba iku didadekne parkiran paribasan ambane bandara.*

(9a) *Lahan sing amba iku dadi sasaran pandadine parkiran paribasan ambane bandara.*

In sentence (9), the nominal phrase *lahan sing amba iku* is neither the speaker nor the listener. Furthermore, this nominal phrase is referred to as the patient because it is the target of the action described in the sentence. This can be proven by examining the word *didadekne* in sentence (9). The word *didadekne* functions as a patientive TPPV with a suffix (-ke). The passive patientive nature of this verb can be demonstrated by transforming *didadekne* using the formula: *dadi sasaran* Pa+/N/+pre-categorial/+/-e/ (becomes the target of /Pa+/N-//pre-categorial/+/-e/). This transformation produces the phrase *dadi sasaran pandadine* (becomes the target of made) in the sentence (9a) as the modified form of sentence (9). In this way, it can be understood that the verb *didadekne* in the sentence (9) represents a patientive TPPV with a suffix (-ke), indicating the speaker's action directed toward the patient *lahan sing amba iku* as its target.

J. Benefactive TPPV with Suffix (-ke) in IESA

(10) S: *Arek-arek pas diumumne nek balik esuk merga ana rapat guru langsung gemrudug ringkes-ringkes bar olahraga. Padahal sik leren bar bal-balan. Terus Pak Dodik teka ngumumne informasi iki. Arek-arek langsung jingkrak- jingkrak. Jan koyok ngeculne dara miber, arek-arek dibalekne isuk ketara seneng banget. Dina Setu mulih isukpas kanggo njagkepi prei sesuke.*

'As soon as the students were told they'd be going home early because of a teachers' meeting, they quickly started packing up right after their sports class. They were still resting after playing soccer. Then Pak Dodik came and announced the news. The students immediately started cheering. It was like releasing doves to fly free; they were visibly thrilled to be sent home early. Going home early on Saturday made up for having Sunday off.'

Data (10) is taken from a conversation between an adult female speaker of high socioeconomic status and strong religious observance, and her conversational partner, a teenage male of low socioeconomic status and low level of religious observance. This informal conversation took place between two family members. More specifically, the speaker is the mother of the conversational partner. Consequently, the speaker uses Javanese in the Ngoko register. At that time, the speaker was telling her conversational partner about her students at school. She observed that her students were very happy because they were sent home early due to a teachers' meeting. The students had just finished a soccer game and appeared tired. However, upon hearing the news from their teacher, Pak Dodik, that they would be dismissed early, they immediately began cheering. The speaker's statement can be classified as an IESA because it contains the word *koyok* 'like' in the italicized sentence. In the conversation, the speaker illustrates 'the students' joy at being sent home early as being like releasing doves to fly free. Additionally, the italicized sentence contains a benefactive TPPV with the suffix /-ke/; here are the details of its categories, functions, and roles.

	<u>koyok ngeculne dara miber</u>	<u>arek-arek</u>	<u>dibalekne</u>
Category	:Adverbial Phrase	Nominal Phrase	Verb
Function	:Adverb	Subject	Verb
Role	:Condition	User	Benefactive TPPV with Suffix (-i)

Third-Person Passive Voice in Illustrative Explanatory Speech Acts by Residents of Sumberejo, Ambulu, Jember

The sentence indicates the presence of the nominal phrase *arek-arek* which functions as the subject and holds the role of the user. That nominal phrase occupies the subject function because it can answer the question: who is sent home? Thus, that nominal phrase qualifies as the subject of the sentence. The verbal phrase *dibalekne* is identified as a verb, as it would remain grammatical if preceded by the word *ora* 'not'. Meanwhile, the function of *dibalekne* is as a verb and serves as a benefactive TPPV with a suffix (-ke). That verb is classified as a TPPV with suffix (-ke) because it originates from the base form of the verb *bali* 'go home' with the prefix /di-/ and suffix (-ne). Additionally, the verb in the underlined sentence in data (8) demonstrates a benefactive quality. Here is the proof.

(10) *Koyok ngeculne dara miber, arek-arek dibalekne.*

(10a) *Koyok ngeculne dara miber, arek-arek ditulung bali.*

In sentence (10), the nominal phrase *arek-arek* is neither the speaker nor the listener. Furthermore, this nominal phrase is referred to as the user because is the purpose of doing the work described in the sentence. This can be proven by examining the word *dibalekne* in sentence (10). The word *dibalekne* functions as a benefactive TPPV with suffix (-ke). The passive benefactive nature of this verb can be demonstrated by transforming *dibalekne* using the formula: *ditulung /verb/* (is helped to /verb/). This transformation produces the phrase *ditulung bali* (is helped to go home) in the sentence (10a) as the modified form of sentence (10). In this way, it can be understood that the verb *dibalekne* in the sentence (10) represents a benefactive TPPV with suffix (-ke), indicating the speaker's actions represent actions of *arek-arek*.

V. CONCLUSIONS

Through research on TPPV in IESA by residents of Sumberejo Village, Ambulu District, Jember Regency, it can be observed that TPPV constructions appear in IESA during everyday conversations. This study further examines the speech acts based on explanatory strategies, along with 10 types of TPPV that feature grammatical constructions and patterns of pragmatic politeness. The grammatical construction of TPPV is strongly influenced by the social context of the speaker and their conversational partner, including social relations, social status, and social situations. This social context is also closely linked to pragmatic politeness patterns that serve as a fundamental guide in performing IESA by the residents of Sumberejo Village, Ambulu District, Jember Regency. These grammatical constructions and patterns of pragmatic politeness arise incidentally in conversations among the residents of Sumberejo Village, Ambulu District, Jember Regency.

REFERENCES

- 1) Anwar, Khaidir. 1995. *Beberapa Aspek Sosio-Kultural Masalah Bahasa*. Yogyakarta: Gajah Mada University Press
- 2) Brown, Penelope dan S.C. Levinson. 1987. *Politeness: Some Universals in Language Usage*. Cambridge: Cambridge University Press
- 3) Chomsky, Noam. 1965. *Aspects of The Theory Syntax*. Cambridge: The MIT Press.
- 4) Ibrahim, Abdul Syukur. 1993. *Kajian Tindak Tutur*. Surabaya: Usaha Nasional
- 5) Ibrahim, Abdul Syukur. 1994. *Panduan Penelitian Etnografi Komunikasi*. Surabaya: Usaha Nasional
- 6) Keraf, Gorys. 1981. *Eksposisi dan Deskripsi*. Jakarta: Nusa Indah
- 7) Lyons, John. 1969. *Introduction to Theoretical Linguistics*. Cambridge: Cambridge University Press.
- 8) Nadar, FX. 2009. *Pragmatik dan Penelitian Pragmatik*. Yogyakarta: Graha Ilmu
- 9) Pateda, Mansoer. 2010. *Semantik LeksikaL*. Jakarta: Rineka Cipta
- 10) Poedjosoedarmo, Soepomo. 1979. *Tingkat Tutur Bahasa Jawa*. Jakarta: Pusat Pembinaan dan Pengembangan Bahasa.
- 11) Sudaryanto. 1993. *Metode dan Aneka Teknik Analisis Bahasa: Pengantar Penelitian Wahana Kebudayaan secara*
- 12) Tarigan, Henry Guntur. 1984. *Pengajaran Pragmatik*. Bandung: Angkasa.



There is an Open Access article, distributed under the term of the Creative Commons Attribution – Non Commercial 4.0 International (CC BY-NC 4.0) (<https://creativecommons.org/licenses/by-nc/4.0/>), which permits remixing, adapting and building upon the work for non-commercial use, provided the original work is properly cited.

Digital Fraud: Analyzing the Latest Trends and Tactics in Cybercrime



Mujiono Hafidh Prasetyo¹, Ahmad Ainun Najib²

^{1,2}Faculty of Law, Universitas Diponegoro, Indonesia

ABSTRACT: Information technology plays an important role, both now and in the future. Information technology is believed to bring great benefits and interests to countries in the world. There are at least 2 (two) things that make information technology considered so important in spurring world economic growth. First, information technology drives demand for information technology products themselves, such as computers, modems, tools for building internet networks and so on. Second, is to facilitate business transactions, especially financial business in addition to other general businesses. Information technology by the countries that are members of the G-8 group is seen as very vital in the future world economic growth, expanding learning opportunities and obtaining information for the world's people.

KEYWORDS: Analytics, Cybercrime, Society

INTRODUCTION

The development of information technology is currently growing rapidly. Seeing this development, it cannot be denied that it can have a negative impact that is no less numerous than the benefits it brings. The new space created is certainly not even if it has a good impact, there are several parties from the millennial generation who are taking advantage of it to commit a crime known as cybercrime. The worrying thing about the ever-changing development of information technology and the rapid development of software is that security is a very crucial issue and everyone risks time and money to protect privacy data on the internet. The potential for data-related crimes is very likely to occur. Several countries have long paid more attention to the security of data in cyberspace. The implementation of this concern is contained in national regulations related to information technology. Indonesia stipulates all rights and obligations related to cyber law in Law Number 19 of 2016 on Electronic Information and Transactions, abbreviated as the ITE Law.

USE OF INFORMATION TECHNOLOGY IN INDONESIA

Indonesia is one of the countries with the largest population in the world. Judging from the Worldometers website, Indonesia is ranked 4th with a total of 266,794,980, below the United States, India and China. Supported by the increasingly wide range of internet services, as well as the cheap prices of devices supporting internet use such as smartphones, personal computers, tablets, laptops and so on, users of Information Technology devices are growing rapidly in Indonesia. Based on the website katadata.co.id, the number of internet users in Indonesia in 1998 only reached 500 thousand, very far compared to 2017 which reached more than 100 million users. According to survey data from APJII (Association of Indonesian Internet Service Providers), internet users in Indonesia in 2017 reached 142 million people or 54.69 percent of the total population in Indonesia. Internet users in 2016 grew 7.9% from the previous year and grew more than 600% in the last 10 years.

INTRODUCTION OF CYBERCRIME

Cybercrime is a new crime that emerged as a result of the development of Information Technology. Cybercrime involves computers in its implementation. Crimes related to the confidentiality, integrity and existence of data and computer systems need special attention, because these crimes have a different character from conventional crimes. However, according to other research, the means used are not only computers but also technology. So, with the very rapid development of technology in Indonesia at this time, especially Information Technology, it makes.

Digital Fraud: Analyzing the Latest Trends and Tactics in Cybercrime

Cybercrime is one of the cases that we really have to pay attention to and be wary of. Because after all, crimes like this will definitely occur in a region or country. It depends on how a region or country tries to handle it. Cybercrime Cases in Indonesia. As time goes by, Cybercrime cases are increasingly common in all parts of the world, including Indonesia. The emergence of several cases of "Cyber Crime" in Indonesia, such as embezzlement of money from banks via computers, cases of pornographic videos uploaded on the internet, hackers, carding or crimes committed to steal other people's credit card numbers and use them in trade transactions on the internet, the spread of viruses on purpose on the internet, cybersquatting which is defined as registering, selling or using domain names with the intention of taking advantage of other people's trademarks or names via the internet and cases of theft of state leaders' documents via the internet, all of these cybercrime cases show symptoms of shifting social problems in the world real.

In practice, this crime uses sophisticated telematics technology that is difficult to see and can be committed anywhere. The modes and motives of cybercrime are increasingly complex, therefore there is no guarantee of security in cyberspace, and there is no computer security system that hackers will continue to try to conquer the most sophisticated security systems, and it is a satisfaction for hackers if they can break into other people's computer security systems. Through the site published by forbes.com, with the article title "The Top Cyber Security Risks In Asia-Pacific In 2017" it was written that in March, a ransomware variant known as KimcilWare was seen targeting websites running the Magento eCommerce platform. This variant is thought to have been developed in Indonesia. Apart from that, it was also stated that perpetrators from Asia Pacific were very active in carding activities (trading credit cards with other people's bank account details).

The tactics, techniques and procedures (TTPs) involved in carding are being shared both in closed groups on Facebook and in deep web forums. Hackers from Bangladesh, Pakistan, India, Philippines and Indonesia were observed to be the most active in this regard. According to a survey conducted by one of the computer security applications, namely Norton, which was uploaded on its official website, it was stated that in the last year more than 978 million adults in 20 global cybercrime countries experienced cybercrime, one of which was Indonesia with a total of 59.45 million adults. who are the perpetrators of cybercrime. And as for the losses, don't worry as Norton also mentioned, the total loss of consumers who were victims of cybercrime globally, in Indonesia, reached a fantastic value of \$3.2 billion. This has explained that Indonesia should be more concerned and understand that cybercrime is a crime that we should be aware of. The more often we connect to the Internet, the greater the possibility that we experience cybercrime. According to one national news article, the most prominent case of cybercrime in Indonesia is hate speech.

In general, both through social media and other means, the National Police handled hate speech cases during 2017 as many as 3,325 cases. Meanwhile in 2016, the Police handled 1,829 cases of hate speech. Not only that, in fact there are still many cyber cases occurring in Indonesia, but unfortunately they still do not receive special attention from the government or the people themselves who are actually the perpetrators and also the victims of these cases, namely the reporting of fake news (Hoaxes). The case of reporting fake news (Hoax) is the case that occurs most often, and is often found around us, every day carried out by our family members, our friends, by the people around us.

Handling Cybercrime in Indonesia

The world faces the same dilemma about how to combat cybercrime and how to effectively promote security to their communities and organizations. Cybercrimes, unlike traditional crimes that are committed in a single geographic location, are committed online and are often not clearly linked to any geographic location. Therefore, a coordinated global response to the problem of cybercrime is needed. One of them is Indonesia, the government is now preparing a strategy to deal with Cybercrime cases which are starting to become a special concern at this time.

One of the efforts that the government has made is by establishing the National Cyber and Crypto Agency (BSSN). BSSN, which was formed taking into account the field of cyber security, is one of the areas of government that needs to be encouraged and strengthened as an effort to increase national economic growth and realize national security. The formation of the BSSN is an effort to organize the National Crypto Agency into a National Cyber and Crypto Agency to ensure the implementation of government policies and programs in the field of cyber security. Apart from that, in this case the National Police as the Indonesian law enforcement apparatus has prepared a special unit to handle this cybercrime, namely UNIT V IT/CYBERCRIME Directorate II Special Economics of the National Police Criminal Investigation Unit. The National Police in this case in particular

The cybercrime unit uses parameters based on UN congress documents on The Prevention of Crime and The Treatment of Offenders in Havana, Cuba in 1999 and in Vienna, Austria in 2000, which define cybercrime as an unlawful act committed using a computer network as a means/tool. or computers as objects, whether to gain profit or not, at the expense of other parties. The existence of enforcers is not appropriate without enforced laws.

Digital Fraud: Analyzing the Latest Trends and Tactics in Cybercrime

Therefore, Indonesia also formed a law to regulate Cybercrime, in this case there are 2 main laws used, namely - Telecommunication Law in Law Number 36/1999 and the Information Transaction Electronics (ITE) Law in Law Number 11/2008. According to in-depth observations made by Leo and Dinita regarding the history of cybercrime cases in Indonesia, it shows that the legal basis for cybersecurity is still weak. Compared to other countries, Indonesia lags behind in terms of ICT security policies and regulations. For example, in Malaysia, there is already a Computer Crimes Act, Digital Signature Act, Telemedicine Act (three of them have been in force since 1997), Multimedia Act (1998), Payment Systems Act (2003) and Personal Data Act (2010). Singapore also has a similar set of regulations. Both existing laws have their own limitations. The Telecommunications Law only concerns the scope of telecommunications, but does not mention telecommunications infrastructure, for example in the context of the internet.

So that makes it difficult to put into context specific cases. Apart from that, while a special law on cybercrime has been implemented through Law of the Republic of Indonesia Number 11 of 2008 concerning Information and Electronic Transactions (ITE), its scope is also limited, because it still requires other laws to complement it. Due to these limitations, criminal cases related to cybercrimes are being punished under the Criminal Procedure Code (KUHP Law), Consumer Protection Law Number 8/1999, Copyright Law Number 19/2002 or Anti-Pornography Law Number 44/2008. However, Electronic Information and Transaction Law Number 11/2008 formed the basis for cybersecurity governance related to (and debated) the country.

Even though it is weak in legislative terms, Indonesia is quite strong in terms of technical and procedural steps. International cooperation is also not considered a problem because Indonesia is increasing its international cooperation with various organizations, security experts and forums

to increase its understanding of global threats. As an embodiment of this principle in cybersecurity, Indonesia has become a full member of APCERT and FIRST and a founder of OIC-CERT. As for technical measures, Indonesia has officially recognized compliance with requirements through SNI / ISO / EIC 27001: 2013 concerning Information Security Management Systems. To increase security awareness and track progress, Indonesia has its own framework for assessing domestic information security across government agencies.

The KAMI Index (National Information Security Index) evaluates five areas of information security: governance, risk management, framework, asset management, and technology. However, there is still a lot of work needed. The absence of an officially recognized national governance roadmap for cyber security is one of the pressing priorities (ITU 2015). In relation to the implementation of international standards, ITU (2015) notes that Indonesia has not officially agreed to a national cyber security and framework. This also applies to certification. Currently, Indonesia does not have a national cybersecurity and officially approved framework for certification and accreditation of national institutions and public sector professionals. The Indonesian Internet Providers Association (APJII) confirmed this finding by adding that currently existing standards are mostly adopted from regional or international entities (interview, 2016).

Public Awareness of IT Security The increase in cybercrime in Indonesia has led the government and legal authorities to take several precautions to reduce the number of crimes on the internet through changes to laws according to technological developments. Providing material on Computer Ethics in Higher Education and Understanding Internet Security Awareness to users. However, it all comes back to each user of Information Technology to be aware of the importance of securing their data and activities. However, unfortunately the level of user awareness in maintaining IT security is still not high. As published on the Hootsuite.com site, the percentage of Indonesian people's attitudes regarding the role of technology and their perspective on privacy is obtained.

CONCLUSION

Cybercrime is actually a crime that uses computer tools and technology as a medium for its crime, where there are three parties directly involved in the occurrence of the case, namely the police as law enforcement officers, the general public as victims, and the perpetrators. In order to prevent or handle cybercrime cases (which are actually quite dangerous than non-cybercrimes), the involvement of the police and the public is needed. Both parties are needed to be smarter and understand the laws or dangers of a crime than the perpetrators so that cybercrime cases cannot be carried out smoothly by the perpetrators. For the most common cybercrime in Indonesia, namely the spread of hoax news, a strong understanding is needed of the impacts that will occur from this crime, as well as the laws that have regulated it, in order to obtain a special formula to prevent the spread of hoax news from happening again.

REFERENCES

- 1) J. Clough, *Principles of Cybercrime*, second edition. 2015.
- 2) Worldometers.info, "Countries in the World by population," 2016. Databooks.co.id, "How many internet users in Indonesia," 2018. Online. Available: <https://databoks.katadata.co.id/datapublish/2018/02/20/berapajumlah-pengguna-internet-di-indonesia>. Arifah, "Cybercrime Cases in Indonesia," *J. Bisnis dan Ekon.*, Vol. 18, No. 2, pp. 185–195, 2011.
- 3) N. Dustri, D. A. N. Aspek, and H. Yang, "Understanding and Anticipating Cybercrime Activities in Daily Online Activities in Education, Government, and Industry and Applicable Legal Aspects," *Snikom*, 2014.
- 4) R. Anto, "Cyber Crime Cases as the Impact of Technology Developments Cyber Crime Cases as the Impact of Communication Technology Developments that Disturb the Community," no. July, pp. 0–12, 2018.
- 5) Ali, "Information Crime (Cybercrime) in the Context of Digital Libraries," vol. V, no. 1, 2012. N. K. Movanita, "This is the Result of the Police's Work in Combating Cybercrime Throughout 2017 - Kompas.com," *Kompas.com*, pp. 1–5, 2017.
- 6) H. Jahankhani, A. Al-Nemrat, and A. Hosseinian-Far, "Cybercrime classification and characteristics," *Cyber Crime Cyber Terror. Investig. Handb.*, no. November, pp. 149–164, 2014. Budiman, "Optimizing the Role of the National Cyber and Encryption Agency," vol. IX, no. 12, 2017.
- 7) P. R. Golose, "The Development of Cybercrime and Efforts to Handle It in Indonesia by the National Police," vol. 4, 2006.
- 8) L. K. Nugraha and D. A. Putri, "Mapping the Cyber Policy Landscape: Indonesia," no. November, 2016.
- 9) M. Danuri, "Trends of Cybercrime and Information Technology in Indonesia," no. January, 2018.
- 10) S. Kemp, "Digital in 2018 in Southeast Asia," 2018.
- 11) M. R. Marwan and Ahyad, "Analysis of the Spread of HOAX News in Indonesia."
- 12) M. Elvia and D. R. Monica, "The Role of the Police in Combating Criminal Acts of Spreading Hoax News," 2018.



There is an Open Access article, distributed under the term of the Creative Commons Attribution – Non Commercial 4.0 International (CC BY-NC 4.0) (<https://creativecommons.org/licenses/by-nc/4.0/>), which permits remixing, adapting and building upon the work for non-commercial use, provided the original work is properly cited.

Negative Effects of Digital Technology on Children's Health



Najiba Sharaf¹, Dr. Ayesha Bahez², Engila Akhtary³

^{1,3}Department of ICT, Kabul University of Medical Sciences, Kabul, Afghanistan

²Department of Microbiology, Kabul University of Medical Sciences, Kabul, Afghanistan

ABSTRACT: Digital technology is being used by kids and teenagers more and more as the world becomes more digital. Computers, smartphones, video games, and digital media are just a few examples of the many types of digital technology that can hold someone's interest for lengthy periods. People of all ages are harmed by the rise of digital technology, but children and teenagers are particularly vulnerable. Teenagers use digital tools to engage with one another and spend more time online. They use it for various purposes, including social connection, education, and entertainment, and they go there for just about anything. Overuse of technology can lead to several health problems, such as obesity, poor sleep, musculoskeletal disorders, developmental challenges, and a lack of physical activity. This article reviews the most recent research on the harmful effects of digital technology on children's health; papers released before 2015 are excluded. Research has indicated that children's improper use of technology, including its content, duration, frequency, and posture, can pose health hazards.

KEYWORDS: Negative, effects, Health, Technology, Child

1. INTRODUCTION

Digital technology encompasses devices like computers, tablets, and mobile phones, along with various activities that children engage in through these devices. These activities include using the internet, visiting social networking sites, chatting online, and playing video games[1]. Adolescents who utilize technology can benefit from virtual classes, wider social networks, and improved visual thinking, among other advantages. It also increases self-esteem, develops creativity, and enhances technical proficiency. Teenagers who use digital devices excessively, however, may experience health problems, privacy concerns, and changes in social norms[2]. Overuse of digital media can affect teenagers' mental health and general well-being[3]. Teenagers are finding it more and more challenging. Social media might be a new issue to consider, and practitioners need to be able to assess risk. Even though there isn't much concrete evidence to support this notion, teens, and experts have a big influence on how social media is viewed regarding mental health. Cyberbullying, privacy concerns, and detrimental effects on mental health and education are among the risks associated with this population's usage of social media [4]. Early studies emphasized how traditional media, like television and movies, can cause severe anxiety and disrupt sleep. More recent research has examined the interactive aspects of modern media, particularly social media, and how they affect depression and anxiety. Social anxiety brought on by avoiding face-to-face encounters, emotional control issues brought on by excessive digital media use, and anxiety and despair associated with unfavorable social comparisons are major areas of worry[5]. Furthermore, studies show that young children's excessive indoor internet use is predicted to have a detrimental effect on their long-term psychological development, physical and mental development, and general health [6]. Teenagers' lives have been impacted by digital technology in a variety of ways, both positively and negatively, depending on how they utilize it. Because most digital devices are easy to use, teens can use them on their own. To reduce the chance of behavioral and psychological issues, parents must make an effort to monitor, regulate, and restrict screen use. As they steadily acquire their digital literacy abilities, teenagers thus require greater parental guidance and assistance [7].

2. DIGITAL TECHNOLOGY TOOLS AND THEIR NEGATIVE EFFECTS

2.1 Computer

A computer has become an essential part of children's lives. Depending on the setting, several studies have indicated that computer use may have a favorable or harmful effect on children's development [8]According to Palmer (2015), children who use

Negative Effects of Digital Technology on Children's Health

computers excessively may display lower levels of creativity, imagination, and language skills, as well as poor focus, lack of attention, and disorganization, all of which can have a detrimental effect on academic progress. A review of 1,657,064 people from 71 nations examined the negative health impacts of sedentary behavior. Results showed that lower self-esteem was associated with more computer use and screen time in general [9].

2.2 Smartphones and Tablets

Nowadays, teens spend the majority of their time using smartphones and screens [10]. According to research, over 50% of 3-year-olds possess a tablet, showing that most kids, even younger ones, have their own devices [11]. According to a recent Pew Research Center survey, the internet is used "almost constantly" by 45% of teenagers, and 95% of them claimed they have access to a smartphone [12]. Additionally, research revealed that the group with the highest smartphone use scores had better scores on daytime dysfunction, anxiety, and depression than the group with the lowest smartphone use [1]. Overuse negatively impacts sociability (social isolation, reduced in-person interactions), physical health (physical discomfort, lack of sleep, low activity), mental health (stress, negative emotions), and academic performance. To decrease smartphone use, participants proposed awareness campaigns, family and social event promotion, physical activity encouragement, and internet usage limits [13].

2.3 Video games

The rapid advancement of mobile technology, which has a significant impact on gaming apps, has caused many desktop functions to be transferred to mobile devices like iPads and smartphones. Mobile video games, designed to be played on devices with internet connectivity, have become more and more popular [14]. However, this rise in mobile gaming has also raised awareness of the negative effects of childhood addiction to mobile games, which can lead to serious harm and social issues [15]. A longitudinal study found a reciprocal relationship between Internet gaming addiction and depression, suggesting that past addiction and depression severity may predict the future severity of both issues. People commonly utilize online gaming as a coping mechanism for emotional distress; nevertheless, prolonged and excessive gaming can lead to disengagement from real-world social connections, which can worsen mental health conditions like depression [16]. According to another study, teens who were addicted to mobile gaming had increased degrees of loneliness, social anxiety, and sorrow, supporting the original theories about these relationships. It's intriguing to note that research has also demonstrated a gender difference in the association between social anxiety and mobile gaming addiction, with a greater correlation seen in male teenagers. This implies that compared to female adolescents, male teenagers may be more susceptible to social anxiety linked to compulsive mobile gaming [17]

2.4 Digital Media

Digital media includes video games, streaming platforms, social media, augmented reality (AR), and virtual reality (VR), which are widely used by teens for pleasure, education, and communication. Along with these usages, some teenagers also gamble online using social media, video games, websites, and smartphone apps [18]. While digital media can provide advantages including early learning chances, health information access, exposure to novel concepts, and increased social interaction, it can also pose problems. There are hazards such as exposure to damaging information, privacy issues, rising obesity and depression rates, and detrimental impacts on learning, sleep, and focus [19]. Also, recent research shows how media use can interfere with sleep, especially when it comes to social media and using mobile devices in bed. Research indicates that increased use of social media and electronics while sleeping raises the possibility of sleep disruptions [20] [21]. Media use at or near bedtime not only affects sleep quality but also negatively impacts school performance. Results from a different study indicated that compared to two hours or less, spending more than two hours on social media was linked to a greater likelihood of experiencing depression often. The risks of experiencing frequent depression were greater while not watching TV than when viewing it [22].

3. HEALTH RISKS OF DIGITAL TECHNOLOGY USAGE

3.1 Digital Technology Usage and EYE

Digital eye strain and computer vision syndrome are two health issues that are becoming more prevalent in kids as a result of their addiction to electronic devices and screens. This condition is because of focusing up close which is difficult and tiring to the eyes and causes dryness and headaches and eventually may lead to more near-sightedness. The following strategies can help prevent these vision issues: adjusting the screen's position from 0 to 15 degrees below eye level, wearing computer glasses, or using anti-glare screens; taking a 20-minute break from focusing on the screen to look at something at least 6 meters away for 20 seconds to help relax the eyes [23]. Asthenopia, often known as digital eye strain, is a subjective feeling of visual exhaustion, eye weakening, or eyestrain brought on by an almost age-related increase in the usage of digital gadgets. Asthenopia is caused by uncorrected refractive defects, accommodative dysfunction, extraocular muscle imbalance, and poor illumination. Patients experience redness, itching, headaches, double vision, blurred vision, overly wet eyes, and dry eye sense. A recent meta-analysis

Negative Effects of Digital Technology on Children's Health

by Ichhujani (2019) found that 19.7% of children had asthenopia. Long-term computer screen staring causes severe accommodation and stresses on the extraocular muscles, which frequently result in asthenopia[24]. The severity of symptoms related to digital device use is influenced by reading distance. 30 to 40 cm from the eyes is the ideal focus distance for writing and reading. Digital eyestrain is facilitated by the fact that smaller electronic gadgets, such as cell phones, are typically held 20 to 30 centimeters away from the eyes. According to recent research by Long et al., reading for 60 minutes on a smartphone results in closer viewing distances and more eye strain symptoms [25]. Additionally, prolonged use of smartphones at near reading distances may contribute to the development of acute acquired comitant exotropia, an uncommon manifestation of exotropia in older children [25]. Moreover, excessive smartphone use at a close reading distance might influence the development of a condition called acute acquired comitant exotropia which is an unusual presentation of exotropia in older children. It can potentially be induced by an increased tonus of medial rectus muscles resulting from disrupted accommodation advergence by video Display work. In these cases, avoiding smartphone usage can decrease the amount of esodeviation leading to successful management of residual exotropia and restoration of binocularity[26]. Blue light or high-energy visible (HEV) light wavelengths are emitted by the majority of backlit digital panels. According to Tosini et al. (2016), there is evidence that blue light exposure can harm the eye over time, increasing the risk and severity of eye problems such as cataracts and age-related macular degeneration. Furthermore, prolonged smartphone use reduces blink rate, which accelerates the evaporation of the tear film and can result in dry eye illness [26] In the meantime, poor posture, postural changes, and musculoskeletal complaints cause excessive eye strain and back hunching, which in turn causes neck and back pain [1].

3.2 Digital Technology Usage and Sleep Quality

Delaying going to bed has been connected in several studies to poor academic performance, learning disabilities, and psychological issues[27]. Media usage may interfere with sleep quality through the increase of psychophysiological arousal caused by stimulating content watched, or through bright light exposure. Bright light may impact sleep by delaying the circadian rhythm when exposure takes place in the evening and also by causing an immediate activation in itself. Sleep may also be negatively impacted by electromagnetic radiation. Furthermore, screen use over two hours per day is significantly associated with long sleep onset latency, especially in children who use more devices at the same time compared with those using only one device[26]. The study by Brockmann, concludes that among children aged between 1 to 4 years old, the presence of a television in the bedroom is associated with significantly reduced sleep quality, sleep terrors, nightmares, and sleep talking[28] Yoshimura et al. have reported that the reduced viewing distance when lying down has a positive correlation to poorer quality sleep ($R^2=0.27P<0.05$), longer sleep latency ($R^2=0.35$, $P<0.05$) and lower sleep efficiency ($R^2=0.38$, $P<0.05$)[29]. In another study about one-fifth of participants, 19.3% (111) used their smartphones at bedtime with lights switched off. They also observed that as age increased, the use of smartphones at bedtime with lights switched off also increased. Studies have previously shown that this type of usage may lead to reduced sleep quality, potentially increasing the likelihood of experiencing other ocular pathologies later in life[28][26]. Udorie stated in her article that usage of social media during late night hours may harm the sense of well-being among adolescents which requires sleeping more than adults. Recent studies point out that adolescents should sleep 9.5 hours per night rather than 7.5 hours which is an average one. Furthermore, signs of being tired, irritable, and depressed can be seen as a result of inadequate sleep hours. Moreover, it causes people to become ill easily like catching colds, flu, and gastroenteritis. In light of all these facts, it is undeniable that people who use social media instead of sleeping at night time can be an open target for physical and mental diseases. If we do not be careful about the usage of social media for children, it may harm all of the kids. Children mean the future and we should take care of our future[30].

3.3 Digital Technology Usage and Critical Thinking

Critical thinking and intellectual outcomes include the ability to originate ideas, examine and evaluate arguments, solve problems using inductive and deductive reasoning, keep an open mind, be interested, be flexible, and be able to develop individuality.

Children's critical thinking abilities are influenced by computers and programs, but so are their learning capacity. This may have happened as a result of a reduction in reading [31]. However, under some circumstances, youngsters under the age of three can learn words through videos. In particular, when the experimenter, parent, or caregiver provides extra verbal and nonverbal information during the live-action sequences, youngsters can learn from the movie [32]. Children and teenagers today spend a lot of time using digital technology; thus, it may be seen as an essential part of their lives. Using digital media more frequently is linked to negative behavior and health outcomes [33]. Unfortunately, the majority of downloaded applications are not made with both parents and kids in mind; they solely focus on rote academic abilities and are not based on standards set by educators or developmental specialists. Excessive internet use has been shown to affect children's mental health and social ties. According to empirical research, kids who use the internet a lot are probably going to spend 100 minutes less with friends and family than kids who use it less. It has also been shown that these children are happier with their virtual internet buddies than with real individuals.

Negative Effects of Digital Technology on Children's Health

As a result, many children would rather communicate with their online pals than with their real family [34]. About half of kids are frequently or sporadically distracted, per research by Yilmaz et al. (2015). Nearly half of the youngsters in the research had sleep abnormalities, slightly more than half had cognitive impairments, and around two-thirds had emotional issues. The findings show that the use of technology has a substantial effect on users' physical and emotional well-being. Being overly connected may have a detrimental impact on mental health, resulting in psychological problems including narcissism, sadness, and unreasonable needs for instant satisfaction.

4.4 Digital Technology Usage and Physical Inactivity

Children's usage of technology significantly predicts their lack of physical exercise. Overuse of cellphones, tablets, computers, and video games is positively connected with a lack of physical exercise, according to research by Kenney and Gortmaker (2017). Technology use disrupts children's everyday routines, which lowers their levels of physical activity, according to the World Health Organization. A major risk factor for increased mortality, physical inactivity is responsible for over 3.2 million deaths worldwide each year. To maintain a healthy body weight, improve sleep patterns, boost metabolism and immunological response, and stabilize blood pressure and glucose levels, frequent physical exercise is essential. The World Health Organization (WHO) states that a developing youngster should engage in moderate-to-intense physical exercise for at least one hour each day. If the daily activity surpasses 60 minutes, the advantage is greater [35]. Studies have indicated that youngsters who use technology extensively have considerably lower levels of physical exercise. In comparison to children who use their gadgets for more than six hours a week, children who use them for less than five hours are often more physically active. Higher technology use is also associated with electronic device ownership. Furthermore, the studied children's levels of physical activity are strongly predicted by variables including screen time, device ownership, parental educational attainment, and the child's age. Reducing screen time requires parental engagement because it can significantly affect a child's level of physical activity [36].

4.5 Digital Technology Usage and Obesity

Obesity is one of the most challenging public health problems that both industrialized and developing countries throughout the world must address. Numerous observational studies discovered links between increased obesity risks and screen media usage. It is believed that exposure to screen media causes childhood obesity, and obesity is a known side effect of screen media exposure [37].

Current statistics on childhood obesity collected by the World Health Organization Commission on ending childhood obesity reveal that the number of overweight or obese infants aged 0 to 5 years has increased from 32 million in 1990 to 41 million in 2016 [38]. WHO estimates that this number will increase to 60 million worldwide by 2035, and simply ensuring that our children consume a nutritious diet won't be enough to prevent this from occurring. Obesity is one of the most challenging public health problems that both industrialized and developing countries throughout the world must address. According to the survey's results [6], the more time a youngster spends in front of a screen each day, the greater their obesity. To explain the link between screen time and childhood obesity, earlier hypotheses were founded on the idea that children who spend excessive amounts of time on screens will be less physically active and hence acquire weight. While experimental studies on the effect of reducing screen time on measurable gains in physical activity did not yield conclusive results, epidemiologic research raises the possibility of considerably more complex causal links [39]. Other studies have also shown several direct links between excessive screen usage and obesity and inactivity. Epidemiologic research indicates that kids who spend more time on screens eat less fruits and vegetables and more energy drinks, snacks, and fast food. As a result, they get a larger proportion of their energy from fats and consume more energy in general. The case for increased calorie intake as a primary cause of childhood obesity and screen time is growing [40].

3.6 Digital Technology Usage and Musculoskeletal System

An Electronic device such as mobile phones and touchscreen devices for many daily purposes like education, communication, and social media as well as research focusing on the effects of these devices on musculoskeletal symptoms/disorders [41] [42]. The examination of the substantial physical impacts of modern mobile devices has highlighted these findings. Therefore, using these gadgets for an extended period shouldn't increase your risk of musculoskeletal problems. The use of electronic devices by teenagers and young adults is associated with musculoskeletal problems, particularly in the upper and lower back, head and neck, and upper extremities [43]. Teenagers with musculoskeletal discomfort reported using laptops at home more frequently than they used desktop computers, but the latter were less readily available. Considering that desktop computers are more ergonomic than laptops, these results may be connected to the usage of electronic gadgets. A recent comprehensive study discovered a link between musculoskeletal diseases, particularly those about neck flexion position, and high phone, text, and game frequency [44]. Adolescents who used at least two electronic devices were more likely to experience musculoskeletal discomfort at a median age of 15 years (compared to 14 years). Musculoskeletal discomfort was linked to cell phone use, and the back, neck, and shoulders

Negative Effects of Digital Technology on Children's Health

were the most common locations for these symptoms. Musculoskeletal pain symptoms were linked to decreased use of electronic games. This review [45]., examined the physical effects of touch technologies and found that more activities like texting, making frequent phone calls, and playing video games, as well as more painful areas in the neck, shoulders, and neck flexion posture, are linked to musculoskeletal disorders and increased muscle activity around the neck. Additionally, the majority of users' technology devices are touchscreens.

4. CONCLUSION AND FUTURE WORKS

Digital technology facilitates and encourages social interactions, as well as participation and engagement in content creation and viewing. However, the effects of technology use are complex and vary based on the type of media, how it is used, the frequency and duration of use, and the unique characteristics of the child or adolescent. Increased digital technology use among children is associated with several health risks, including poor sleep quality, obesity, musculoskeletal issues, physical inactivity, and developmental problems. For teenagers, overuse of digital devices introduces additional risks, such as digital eye strain and musculoskeletal disorders linked to excessive texting. Furthermore, prolonged exposure to digital technology has been connected to sleep loss and disruptions in daily activities, which contribute to decreased physical activity levels. To mitigate these risks, parents should establish limits on their children's internet usage and closely monitor their activities. It is also important to delay the introduction of technology to young children to foster optimal physical, mental, and social development. By implementing effective strategies for managing both online and offline interactions and staying informed about key issues, parents can provide the necessary support. Finally, further research is needed to identify the most effective health education strategies to raise parental awareness and promote healthier technology use among children and adolescents.

ACKNOWLEDGMENTS

I would like to thank my colleagues for their wonderful collaboration. You supported me greatly and were always willing to help me.

REFERENCES

- 1) D. Karadefelt-Winther, "How does the time children spend using digital technology impact their mental well-being, social relationships and physical activity?," 2017.
- 2) C. L. Odgers and M. R. Jensen, "Adolescent development and growing divides in the digital age," *Dialogues Clin Neurosci*, vol. 22, no. 2, 2020, doi: 10.31887/DCNS.2020.22.2/codgers.
- 3) J. Meates, "Problematic digital technology use of children and adolescents: Psychological impact," *Teachers and Curriculum*, vol. 20, 2020, doi: 10.15663/tandc.v20i1.349.
- 4) M. Khalaf, A. A. Alubied, A. M. Khalaf, and A. A. Rifaey, "The Impact of Social Media on the Mental Health of Adolescents and Young Adults: A Systematic Review," *Cureus*, 2023, doi: 10.7759/cureus.42990.
- 5) E. Hoge, D. Bickham, and J. Cantor, "Digital media, anxiety, and depression in children," *Pediatrics*, vol. 140, 2017, doi: 10.1542/peds.2016-1758G.
- 6) B. Dresp-Langley, "Children's health in the digital age," 2020. doi: 10.3390/ijerph17093240.
- 7) N. N. Rose, A. S. Ishak, N. H. H. Sultan, F. Ismail, and A. Fahrudin, "Effect of Digital Technology on Adolescents," 2021. doi: 10.4018/978-1-7998-8318-0.ch001.
- 8) Rikuya Hosokawa and Toshiki Katsura, "Association between mobile technology use and child adjustment in early elementary school age," 2018.
- 9) V. Carson, M. S. Tremblay, J. P. Chaput, and S. F. M. Chastin, "Associations between sleep duration, sedentary time, physical activity, and health indicators among Canadian children and youth using compositional analyses," *Applied Physiology, Nutrition and Metabolism*, vol. 41, no. 6, 2016, doi: 10.1139/apnm-2016-0026.
- 10) CSM, "The Common Sense Census: Media Use by Tweens and Teens | Common Sense Media," *Common Sense Media*, 2015.
- 11) H. K. Kabali *et al.*, "Exposure and use of mobile media devices by young children," *Pediatrics*, vol. 136, no. 6, 2015, doi: 10.1542/peds.2015-2151.
- 12) Monica and Jingjing Jiang, "Teens, Social Media & Technology 2018," *Publicservicealliance.org*, 2018.
- 13) M. S. Alotaibi, M. Fox, R. Coman, Z. A. Ratan, and H. Hosseinzadeh, "Perspectives and Experiences of Smartphone Overuse among University Students in Umm Al-Qura University (UQU), Saudi Arabia: A Qualitative Analysis," *Int J Environ Res Public Health*, vol. 19, no. 7, 2022, doi: 10.3390/ijerph19074397.

Negative Effects of Digital Technology on Children's Health

- 14) Y. S. Su, W. L. Chiang, C. T. James Lee, and H. C. Chang, "The effect of flow experience on player loyalty in mobile game application," *Comput Human Behav*, vol. 63, 2016, doi: 10.1016/j.chb.2016.05.049.
- 15) S. Feng, "The Detrimental Effects of Mobile Game Addiction on Chinese Primary School Students and Possible Interventions," *Science Insights Education Frontiers*, vol. 13, no. 2, pp. 1911–1922, Dec. 2022, doi: 10.15354/sief.22.re071.
- 16) D. L. King and P. H. Delfabbro, "The Cognitive Psychopathology of Internet Gaming Disorder in Adolescence," *J Abnorm Child Psychol*, vol. 44, no. 8, 2016, doi: 10.1007/s10802-016-0135-y.
- 17) J. L. Wang, J. R. Sheng, and H. Z. Wang, "The association between mobile game addiction and depression, social anxiety, and loneliness," *Front Public Health*, vol. 7, no. SEP, 2019, doi: 10.3389/fpubh.2019.00247.
- 18) J. S. Radesky, J. Schumacher, and B. Zuckerman, "Mobile and interactive media use by young children: The good, the bad, and the unknown," 2015. doi: 10.1542/peds.2014-2251.
- 19) Y. R. Chassiakos *et al.*, "Children and adolescents and digital media," *Pediatrics*, vol. 138, no. 5, 2016, doi: 10.1542/peds.2016-2593.
- 20) J. C. Levenson, A. Shensa, J. E. Sidani, J. B. Colditz, and B. A. Primack, "Social media use before bed and sleep disturbance among young adults in the United States: A nationally representative study," *Sleep*, vol. 40, no. 9, 2017, doi: 10.1093/sleep/zsx113.
- 21) L. Hale *et al.*, "Youth Screen Media Habits and Sleep: Sleep-Friendly Screen Behavior Recommendations for Clinicians, Educators, and Parents," 2018. doi: 10.1016/j.chc.2017.11.014.
- 22) L. Ma, B. Evans, A. L. Kleppang, and C. Hagquist, "The association between screen time and reported depressive symptoms among adolescents in Sweden," *Fam Pract*, vol. 38, no. 6, 2021, doi: 10.1093/fampra/cmab029.
- 23) Y. Alghamdi, "Negative Effects of Technology on Children of Today," 2016, doi: 10.13140/RG.2.2.35724.62089.
- 24) P. Ichhpujani, R. B. Singh, W. Foulsham, S. Thakur, and A. S. Lamba, "Visual implications of digital device usage in school children: A cross-sectional study," *BMC Ophthalmol*, vol. 19, no. 1, 2019, doi: 10.1186/s12886-019-1082-5.
- 25) J. Long, R. Cheung, S. Duong, R. Paynter, and L. Asper, "Viewing distance and eyestrain symptoms with prolonged viewing of smartphones," *Clin Exp Optom*, vol. 100, no. 2, 2017, doi: 10.1111/cxo.12453.
- 26) E. Bozzola *et al.*, "Media devices in pre-school children: The recommendations of the Italian pediatric society," *Ital J Pediatr*, vol. 44, no. 1, Jun. 2018, doi: 10.1186/s13052-018-0508-7.
- 27) B. Galland, K. Spruyt, P. Dawes, P. S. McDowall, D. Elder, and E. Schaughency, "Sleep disordered breathing and academic performance: A meta-analysis," 2015. doi: 10.1542/peds.2015-1677.
- 28) P. E. Brockmann, B. Diaz, F. Damiani, L. Villarroel, F. Núñez, and O. Bruni, "Impact of television on the quality of sleep in preschool children".
- 29) M. Yoshimura, M. Kitazawa, Y. Maeda, M. Mimura, K. Tsubota, and T. Kishimoto, "Smartphone viewing distance and sleep: An experimental study utilizing motion capture technology," *Nat Sci Sleep*, vol. 9, pp. 59–65, 2017, doi: 10.2147/NSS.S123319.
- 30) TEMÜR, "Negative Effects of Social Media on Children," 2017.
- 31) S. Gerardi, "Use of Computers/Apps and the Negative Effects on Children's Intellectual Outcomes," *Sociology Mind*, vol. 07, no. 03, pp. 128–132, 2017, doi: 10.4236/sm.2017.73009.
- 32) M. Ebbeck, H. Y. B. Yim, Y. Chan, and M. Goh, "Singaporean Parents' Views of Their Young Children's Access and Use of Technological Devices," 2016.
- 33) N. Ahmed, I. Zahra, and A. A. Alanazi, "Digital Childhood: the Impact of Using Digital Technology on Children's Health," Available online www.ijpras.com *International Journal of Pharmaceutical Research & Allied Sciences*, vol. 8, no. 3, pp. 144–154, 2019, [Online]. Available: www.ijpras.com
- 34) Orben and A. K. Przybylski, "The association between adolescent well-being and digital technology use," *Nat Hum Behav*, vol. 3, no. 2, 2019, doi: 10.1038/s41562-018-0506-1.
- 35) T. Alotaibi, R. Almuhanha, J. Alhassan, E. Alqadhib, E. Mortada, and R. Alwhaibi, "The relationship between technology use and physical activity among typically-developing children," *Healthcare (Switzerland)*, vol. 8, no. 4, 2020, doi: 10.3390/healthcare8040488.
- 36) E. L. Kenney and S. L. Gortmaker, "United States Adolescents' Television, Computer, Videogame, Smartphone, and Tablet Use: Associations with Sugary Drinks, Sleep, Physical Activity, and Obesity," 2017.
- 37) T. N. Robinson *et al.*, "Screen media exposure and obesity in children and adolescents," *Pediatrics*, vol. 140, 2017, doi: 10.1542/peds.2016-1758K.

Negative Effects of Digital Technology on Children's Health

- 38) World Health Organization, "Commission on ending childhood obesity Facts and figures on childhood obesity," *Commission on Ending Childhood Obesity*, 2019.
- 39) Z. Gao, S. Chen, D. Pasco, and Z. Pope, "A meta-analysis of active video games on health outcomes among children and adolescents," *Obesity Reviews*, vol. 16, no. 9, 2015, doi: 10.1111/obr.12287.
- 40) N. Stiglic and R. M. Viner, "Effects of screentime on the health and well-being of children and adolescents: A systematic review of reviews," 2019. doi: 10.1136/bmjopen-2018-023191.
- 41) E. Gustafsson, P. Coenen, A. Campbell, and L. Straker, "Texting with touchscreen and keypad phones - A comparison of thumb kinematics, upper limb muscle activity, exertion, discomfort, and performance," *Appl Ergon*, vol. 70, 2018, doi: 10.1016/j.apergo.2018.03.003.
- 42) E. H. C. Woo, P. White, and C. W. K. Lai, "Musculoskeletal impact of the use of various types of electronic devices on university students in Hong Kong: An evaluation by means of self-reported questionnaire," *Man Ther*, vol. 26, 2016, doi: 10.1016/j.math.2016.07.004.
- 43) Y. Jamie L *et al.*, "Effects of Electronic Usage on the Musculoskeletal System in Adolescents and Young Adults: A Systematic Review," *J Musculoskelet Disord Treat*, vol. 8, no. 2, Jun. 2022, doi: 10.23937/2572-3243.1510114.
- 44) S. H. Toh, P. Coenen, E. K. Howie, and L. M. Straker, "The associations of mobile touch screen device use with musculoskeletal symptoms and exposures: A systematic review," *PLoS One*, vol. 12, no. 8, 2017, doi: 10.1371/journal.pone.0181220.
- 45) O. KORHAN and A. ELGHOMATI, "THE IMPACT OF MOBILE TOUCH SCREEN DEVICE USE ON MUSCULOSKELETAL SYSTEM: A LITERATURE REVIEW," *Ergonomi*, vol. 2, no. 3, pp. 137–146, Dec. 2019, doi: 10.33439/ergonomi.531434.



There is an Open Access article, distributed under the term of the Creative Commons Attribution – Non Commercial 4.0 International (CC BY-NC 4.0) (<https://creativecommons.org/licenses/by-nc/4.0/>), which permits remixing, adapting and building upon the work for non-commercial use, provided the original work is properly cited.

Images of Buddha and the Great Deities of Brahmanism in the Original Buddhist Panthem from the Practice of Thailand and Vietnam



Vu Hai Thien Nga

Thu Dau Mot University

ABSTRACT: Buddhism is a major religion in the world, it was born in India 2600 years ago, and has spread to many countries, including Vietnam and Thailand. Due to the same origin, the image of Buddha in Thailand and Vietnam has many things in common, and is closely associated with the culture of worshiping the great Brahmanical gods. However, in the process of migration, combined with the different cultures between countries, the image of Buddha and the Great Brahmanical God has had differences between the two countries. In this article, the group of authors focuses on clarifying the image of Buddha and the Great Brahmanical God in the original Buddhist temples of the two countries of Vietnam and Thailand, thereby comparing the differences between them to understand the religious culture of each country.

KEYWORDS: Buddha, Great Brahman God, Theravada Buddhism, Thailand, Vietnam.

I. PROBLEM STATEMENT

The primitive era, Buddhism is the period when Buddha was born, lasting 100 years after Buddha's Nirvana, is the era of pure Buddhism. Primitive Buddhism was born due to the need for adaptation of people, the contemporary Indian society led to: people were dependent on Gods, the philosophical thoughts of sublime religions, making people confused and vague. Every religion wants to bring out philosophical thoughts to deeply impact people's spiritual life, the division of classes has created injustice, exploitation of labor, oppression, slavery, lack of freedom, inequality, imbalance in life, the desire to have something that can free them from both material and spiritual suffering. The birth of Buddhism has responded to those aspirations, when it brought new ideas of life, more adaptive and suitable than dependence on God, no longer dominated by contemporary social classes, inequality, instead there is freedom of belief, freedom of worship, freedom between people, no longer distinguishing between classes, status, emphasizing the right to control destiny and fate. From the origin of primitive Buddhism, it has led to the formation of the image of Buddha and the great Brahmanical gods, which are increasingly rich and diverse; a characteristic of the long historical process and cultural beliefs that exist to this day.

Thailand and Vietnam are two countries that have been influenced by the introduction of primitive Buddhism very clearly in the lives of the majority of people, becoming an indispensable spiritual culture. So what is the difference between the relationship between Buddhism and Brahmanism, as well as the relationship between the image of Buddha and the great Brahmanical gods in the primitive Buddhist pantheon in two typical countries, Vietnam and Thailand?

II. RESEARCH METHODS

To study the image of Buddha and the Great Brahman Gods in the primitive Buddhist temples of Thailand and Vietnam, the group of authors used the main method of collecting, analyzing and synthesizing documents. Based on the analyzed and synthesized documents, the group of authors combined with the method of field survey at some pagodas in Tra Vinh and Ho Chi Minh City to conduct comparisons and assessments to clarify the differences in the image of Buddha in primitive Buddhism between Vietnam and Thailand.

Images of Buddha and the Great Deities of Brahmanism in the Original Buddhist Pantheon from the Practice of Thailand and Vietnam

III. RESEARCH CONTENT

1. Images of Buddha and great Brahmanical deities in the original Buddhist pantheon in Thailand and Vietnam

1.1. In Thailand

The results of some archaeological excavations have shown traces of Buddhism in Thailand. The excavation at the famous Buddhist stupa: Nakhon Phra Chedi (located in Nakhon Phathom), there are many Buddhist traces such as Buddha plaques, Dharmachakras and deer statues symbolizing the Buddha's first sermon at Sarnath. The existence of Buddha plaques and deer statues without Buddha statues shows that Central Thailand had contact with India at a time when Buddha statues had not yet been formed, and the Buddha was only represented by symbols.

Excavations at Pong Tuk have found many architectural foundations and fragments of stone pillars, which can be recognized as the main hall of a Buddhist temple similar to the Anuradhapura temple in Ceylon (Sri Lanka). Among the Buddha images discovered at Pong Tuk are many bronze and limestone Buddha images, reliefs depicting the life of the Buddha. These works of art are related to the art of the Gupta period in India (dated: 300-600). However, there is also a bronze Buddha image in the Amaravati style originating from South India dated to the 2nd century. All these evidences indicate the involvement of early Buddhism in present-day Central Thailand [5].

1.1.1. The Buddha and the Brahmanical Gods in the Early Period

Historical studies show that the Mon people in the Dvaravati Kingdom (now part of Thailand) followed Theravada Buddhism very early. The oldest stele of Theravada Buddhism was found in Nakhon Pathom Province, dating back to around the 6th century AD. Other Buddhist relics of the Dvarati Kingdom were also discovered at two archaeological sites, Pra Pathom and Pong Tuk. One of the most impressive features of Mon Theravada Buddhist art is the depiction of the Buddha descending from the Tavatimsa heaven with the Brahmanical gods Indra and Brahma. Another sculpture depicts the Buddha standing on the head of the King of the Jungle (the King of the Jungle (Pana-Bati) is a beast with the beak of the eagle Garuda, the ears and horns of the divine bull Nandin (the mount of the god Shiva), and the wings of the divine goose Hamsa (the mount of the god Brahma)). The image shows the superiority and power of the Buddha over the Brahmanical gods. The image is also seen on a bas-relief depicting the two Brahmanical gods Vishnu and Shiva and two other gods listening to the Buddha's sermons standing in the middle of the gods. The Mon carvings show that the relationship between primitive Buddhism and Brahmanism was formed as soon as Buddhism arrived in Southeast Asia in general and in Thailand in particular. In particular, the role of the Buddha was elevated to the highest position. The Brahmanical gods, especially the two main gods Vishnu and Shiva revered in Thailand, became the Buddha's assistant gods (although Brahma is the supreme god, Vishnu and Shiva are the two most popular gods). This harmony did not diminish the role of the Buddha but on the contrary, increased the respect for Buddhism [5].



Hình 1: Đức Phật cùng thần Vishnu và Shiva đứng trên mình thú chủ Vanaspati. [7].

1.1.2. The Buddha and the Brahmanical Gods in the Late Period

Buddhists following the original Buddhist sect in the Khmer people of the South or in mainland Southeast Asian countries highly value the role of Brahmanical gods, such as Brahma (the Creator), Vishnu (the Preserver), Shiva (the Destroyer), and Indra (the Thunder God) in the original Buddhist pantheon. Similar to the culture of the Mon people before, Brahmanical gods are still present in the original Buddhist pantheon of the Buddha, but the Buddha is still revered as a Teacher of the three worlds.

Images of Buddha and the Great Deities of Brahmanism in the Original Buddhist Pantheon from the Practice of Thailand and Vietnam

In the early historical period of the Thai people, the Sukhothai Dynasty had two giant Buddhist temples, Pra Pai Luang and Sisawai, built to worship Buddha and Brahmanical gods, such as: Vishnu, Shiva, Uma, Lakshmi, Ganesha... Many temples in Thailand have the same way of arranging statues according to the principle: Buddha sits in the middle of the main hall, around and on the gable appear four statues of gods: Brahma, Vishnu, Shiva and Indra, in the role of heavenly kings protecting Him. The paintings on the walls of primitive Buddhist temples often depict the life of the Buddha, with the opening scene of the story of Buddha's birth in Lumpini Garden with the four main Brahmanical gods: Brahma, Vishnu, Shiva and Indra worshipping Him.

During the fourteenth century, Theravada Buddhism in Thailand received additional Brahmanical elements from the Khmer religious tradition, which had been fused with Buddhism since the Angkorian period. An inscription dated 1361, during the reign of King Boromaraja I of Thailand, describes: the king must revere the Buddha but also possess knowledge of the Vedas and Brahmanical astrology.

The problem of reconciling Theravada Buddhism with Brahmanism continued to develop in an increasing trend after 1431, when Thailand invaded Angkor. The influence continues into the present period, but the Brahmanical tradition has not been able to replace Theravada Buddhism as the state religion in the societies of Thailand, Laos, Cambodia and Myanmar.

In the cultures of most Theravada Buddhist countries, Brahmanical mythology has been transformed into Buddhist mythology, with stories showing the relationship between the Buddha and gods and sacred creatures, such as the Garuda bird, Kinari, the Airavata elephant and the Naga snake. The names of the main Brahmanical gods are also changed to their native or Pali names such as Phra Phrom (Brahma), Pra Isuan (Shiva), Phra In (Indra), Phra Narai (Narayana) and Burana (Vanura). The high and low positions of Brahmanical gods in the Theravada Buddhist pantheon are also changed according to local concepts. In Thailand, Vishnu is the image of the king, considered by Buddhists as the Dharmaraja, the leader of the gods protecting Buddhism; Lord Shiva observed the Buddhist precepts by staying away from the world and practicing asceticism on Mount Kalaisa (Buddhist Mount Sumeru), so he was considered the Buddha's closest disciple.

In Thai art, the motif of Buddha sitting in the middle with Vishnu and Shiva protecting him on both sides often appears. Next is Brahma, who helps Buddha teach the Dharma and suppress demons, so Brahma statues are often erected at intersections. Finally, Indra rides the three-headed snake Naga to help Buddha make rain to save people, so his statue is often placed on the roof of temples [5].

1.2. In Vietnam

1.2.1. Khmer Southern Buddhism

Besides the Northern Buddhism that has a profound influence on the Vietnamese community, Vietnam also received another Buddhist tradition from the South, which is Southern Buddhism, or Theravada Buddhism. The group of residents who were most influenced by Theravada Buddhism were the Khmer people, who lived mainly in the Mekong Delta. They received the Southern Buddhism sect most deeply starting from the decline of the Angkor empire, after the 14th century. This was also the period that marked the peak of decline of Brahmanism, which had dominated the Khmer royal court since the 6th century.

Currently, Khmer Theravada Buddhism has 450 pagodas, of which Tra Vinh province has the largest number with 142. Notably, in Ho Chi Minh City, there are also two Khmer Theravada pagodas, Candaransi and Po Thi Vong. In Hanoi, there is a symbolic Khmer Theravada Buddhist pagoda located in the Cultural Village of Vietnamese Ethnic Groups.

Khmer Theravada temples are deeply influenced by the worship of Brahmanical gods. For example, Quy Nong Pagoda - an ancient pagoda of the Khmer Theravada Buddhist sect located in Chau Thanh district, Tra Vinh province: on the ceiling of the main hall (Vihana) are decorated with drawings of Hera (a mascot combining the Naga snake god and the Chinese dragon. The origin of this mascot comes from Thailand in the late 18th century when the cultural exchange between the Thai and Chinese people became stronger in Thailand); or on the facade of the monastery building is the image of King Chan Krong Kriep (a guardian deity. In the cosmological concept of Khmer Theravada Buddhism, King Chan Krong Kriep is considered the guardian deity of the North according to the Brahmanical belief of the Eight Directions of the World, which influenced Khmer Theravada Buddhism).

Our field survey found that: the monks' quarters of Quy Nong Pagoda are located to the north of the main hall, the face of King Chan Krong Kriep is designed to look towards the main hall to worship Buddha and protect the Three Jewels. Outside the main hall of Quy Nong Pagoda, the Khmer designed a shrine on which a Buddha statue in a walking posture is placed, this feature is very similar to the famous Chiang Sean style Buddha statues of Thailand. Another characteristic between Quy Nong Pagoda and Wat Phra Keo of Thailand is the representation of the Khmer epic Riemke (Riêm – Kê) in wood drawings, then decorated around the main hall. The age of these collections is from the early 20th century, similar to the mural paintings around the Temple of the Emerald Buddha about the epic Rama-kien of Thailand.

Images of Buddha and the Great Deities of Brahmanism in the Original Buddhist Pantheon from the Practice of Thailand and Vietnam

In addition, we must mention the four-faced Thai statues of Phra Phrom (Brahma), also known as Erawan, present in the shrines in front of the main hall of Po Thi Vong Pagoda in Ho Chi Minh City and Quy Nong Pagoda in Tra Vinh Province. The shrine is usually built in front of the main hall, according to the concept that Maha Phra Phrom guards the sacred path leading to Tudi Mountain of Buddha. The Maha Phra Phrom statue is often depicted with four faces, wearing a Kiritamukuta-style hat (glorious hat) for the emperor, based on the description in the Indian genealogy. The god's clothing is in the style of ancient Thai costumes. The posture is sitting on a throne, the right leg is on the throne, the left leg is on the ground. The god has eight hands, holding treasures with meanings: the hand holding the Order Flag represents "Universal Dharma Power"; holding the Buddhist scriptures (actually the Vedas) represents Wisdom; holding the Dharma conch (precious snail) represents blessing; Holding the Wheel of Light symbolizes the destruction of afflictions; holding the scepter symbolizes the Supreme Accomplishment; holding the water jar symbolizes the blessing of saving the world; holding the Reciting Pearl symbolizes mastery over Samsara. The other hand forms a mudra in front of the chest to symbolize protection [7].

1.2.2. Theravada Buddhist sect

The Vietnamese in the South came to know about Khmer Theravada Buddhism during the process of settling and living together with the Khmer people. This predestined relationship fostered the propagation of the Theravada Buddhism into the Vietnamese community. The propagation of the Dharma took place in 1939, when the missionary delegation of Venerable Ho Tong, along with other Vietnamese eminent monks such as Venerable Thien Luat and Venerable Hue Nghiem, came from the capital Phnom Penh to Saigon to preach about the practice of the Theravada Buddhism. One year later (1940), the first pagoda of the Kinh Theravada Buddhism was established, which was Buu Quang Pagoda (today the pagoda has become one of the important ancestral temples of the Kinh Theravada Buddhism). In 1958, the Vietnam Primitive Sangha Church was established, officially marking the birth of the Kinh Theravada Buddhism in Vietnam, existing alongside other Buddhist sects. Today, Theravada Buddhism is one of nine sects and organizations of the Vietnam Buddhist Sangha.

According to the principles of Southern Buddhism, the main hall only houses a statue of Buddha Shakyamuni. In addition to the statue of Buddha Shakyamuni, images of deities originating from Thailand are also present in Southern Buddhist temples, such as the small shrine to the Thai god Phra Phrom (Brahma) located in front of the Gotama Stupa of Buu Long Pagoda. The pedestal of the shrine is embossed with the image of the three-headed elephant god Airavat, the mount of the god Phra In (Indra). On the left side of the stupa is a majestic four-faced statue of the god Phra Phrom, made in the traditional style of the Thai people but called by the Vietnamese as Pham Thien or Tu Dien Phat. At Thien Minh Zen Monastery in Vinh Long province, there is also a small shrine to the goddess Sakko Devino (wife of the god Sakka (Sakko) or god Phra In (Indra)). The statue is depicted in a throne position: the left hand makes a mudra, the right hand holds a scepter to protect the Buddha Dharma and govern the Three Realms. From there, we can see the integration characteristics of Kinh Theravada Buddhism with Theravada Buddhist countries in the current period [7].



Hình 2: Bích họa đức Phật và hai vị thần Shiva và Brahma tại Chùa Monivongsa Bopharam

Images of Buddha and the Great Deities of Brahmanism in the Original Buddhist Pantheon from the Practice of Thailand and Vietnam

2. The difference between the image of Buddha and the great Brahman gods from Thai and Vietnamese practice

Buddhism in Southeast Asian countries in general and in Thailand and Vietnam in particular have similarities in cultural beliefs, in the proportion of people who worship Buddha, which is usually the majority and has a great influence on their material and spiritual life. However, due to historical contexts and different political and social factors, there have been differences in the images of Buddha and the great Brahman gods in the original Buddhist pantheon, which is most clearly shown in the main halls of temples in Thailand and Vietnam today.

Firstly, in Thailand, which is considered to be deeply influenced by the introduction of Buddhism from India, the temple clearly depicts the image of the Buddha with the two gods Vishnu and Shiva beside him to protect the Dharma. However, in practice in Vietnam, there are unique characteristics, divided into two sects: Khmer Southern Buddhism and Kinh Southern Buddhism. Although these two sects both illustrate the image of the Buddha with gods originating from Brahmanism, each sect has a different name, the combination of the image of the Buddha and the gods is also different (not only commonly seen in Thailand with gods Vishnu and Shiva) such as: Brahma, Indra, Chan... This difference comes from the beliefs, culture and history of the introduction of Buddhism between the two countries [6].

Second, in general, Buddhism from Thai practice has a deeper influence on people's lives, from birth to death, along with rituals associated with their culture. But in Vietnam, this is not as popular as in Thailand, the Southern Buddhist sect is mainly in the provinces in the Southwest, so the customs here are often known through travel and exploration, not deeply associated with material and spiritual life like in Thailand. In Vietnam, it can be affirmed that the Northern Buddhist sect accounts for a very high proportion and majority compared to the Southern Buddhist sect.

Although there are differences, according to the Buddha's teachings, the differences are only signs and external appearances due to geographical characteristics, local religious customs on the land of residence and the influence of many ignorant forces. These differences are not intended to divide sects but to have a comprehensive view, create sympathy, harmony with each other, solidarity in Buddhist affairs, recognize the difficulties of the path of practice, suffering, find ways to eliminate suffering, build a common path of happiness for the people.

IV. CONCLUSION

Buddhism brings people a gentle spiritual life, knowing compassion, joy, letting go and enlightenment on the path to liberation, making people have faith in the context of unpredictable changes in life, especially in the context of an increasingly developing market economy. Through the length of history, with many different sects, depending on the conditions of economic and social development, the traditional culture of each nation, the form of practice and belief in each country is also different, however, the Buddhist perspective on practice has not changed, still keeping the essence of guiding people to do good and avoid evil.

The image of Buddha in Thailand and Vietnam is generally deeply influenced by India, associated with the culture of worshipping the great gods of Brahmanism. Although there are differences, these are also unique features, clearly demonstrating the historical process of introducing and spreading Buddhism over thousands of years of history. Although there are differences, according to the teachings of Buddha, the differences are only signs, external appearances due to geographical characteristics, local religious customs on the land of residence and the influence of many ignorant forces. These differences are not intended to divide sects but to have a comprehensive view, create sympathy, harmony with each other, solidarity in Buddhist affairs, recognize the difficulties of the path of practice, suffering, find ways to eliminate suffering, build a common path of happiness for the people.

The differences in cultural beliefs, the differences in the images of Buddha and the great Brahman gods in the original Buddhist temples in Thailand and Vietnam contribute to clarifying the characteristics of Buddhism in the two countries, and at the same time show the beauty of truth, goodness, and beauty of the people, towards a prosperous, happy life, a peaceful family, a beautiful life, and a beautiful religion.

REFERENCES

- 1) Le Thi Ngoc Diep (2014), *The ethical values of Theravada Buddhism in Vietnamese culture*, Theravada Buddhism Magazine No. 38, March 2014, pp. 7 - 12.
- 2) Vu Ngoc Dinh (2021), *The role of Buddhism in the field of ideology and social ethics*, Buddhist Culture Magazine No. 367, pp. 56 - 62.
- 3) Andrew Skilton (Dharmacari Sthiramati) (2003), *General history of world Buddhism*, Ho Chi Minh City General Publishing House, pp. 118 - 123.

Images of Buddha and the Great Deities of Brahmanism in the Original Buddhist Panthem from the Practice of Thailand and Vietnam

- 4) Thich Nu Chon Pho (2015), *Characteristics of Primitive Buddhism*, Primitive Buddhism Magazine No. 45, October 2015, pp. 20 - 25.
- 5) University of Social Sciences and Humanities and Vietnam Institute of Buddhist Studies (2013), *Primitive Buddhism from tradition to modernity*, pp. 63 - 69.
- 6) Phan Anh Tu (2015), *The influence of the worship of Phra Phrom and Nang Kwak in the South in the context of regional exchange*, Journal of Religious Studies No. 07 (145), 2015, 07-98.
- 7) Phan Anh Tu (2017), *Vietnamese Theravada Buddhism in relation to Thai Buddhist culture*, Proceedings of the international scientific conference: Vietnam - Thailand: Building a strong strategic partnership in the period of international integration and regional linkage in 2017, pp. 101 - 109.

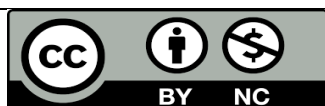

There is an Open Access article, distributed under the term of the Creative Commons Attribution – Non Commercial 4.0 International (CC BY-NC 4.0) (<https://creativecommons.org/licenses/by-nc/4.0/>), which permits remixing, adapting and building upon the work for non-commercial use, provided the original work is properly cited.

Ṣaṭ Pāramitā and Its Application Values in Building Ethics of Vietnamese Business People Today



Le Quoc Binh

Tran Nhan Tong Institute - VNU

ABSTRACT: This article examines the application of ṢAṬ PĀRAMITĀ, the Six Perfections of Mahayana Buddhism, in Vietnamese business ethics. Virtues like Generosity, Ethical Conduct, Patience, Diligence, Meditation, and Wisdom provide a foundation for fostering trust, integrity, and sustainable growth. Examples from leading Vietnamese companies such as VinGroup and FPT illustrate how these teachings align with corporate social responsibility and ethical leadership, enhancing public trust and engagement. Research from the Vietnam Chamber of Commerce and Industry (VCCI) shows that companies practicing these values see higher trust and employee satisfaction. Recommendations include integrating these virtues into training and policy, with further studies suggested for measuring their impact.

KEYWORDS: ṢAṬ PĀRAMITĀ; Business Ethics; CSR; Vietnamese Enterprises; Ethical Leadership; Sustainable Growth

1. INTRODUCTION

In an era of global economic integration, ethics in business have become a critical component for sustainable growth. For Vietnamese enterprises, maintaining ethical practices is essential to complying with global standards and building trust within society (Thanh et al., 2023). Ethical behavior supports sustainable development and positions businesses as trustworthy entities in domestic and international markets (Thanh et al., 2023). However, maintaining a balance between profit-oriented strategies and ethical practices presents a challenge in the competitive business environment (Tung, 2021).

The teachings of Buddhism, which have deep cultural roots in Vietnam, offer a valuable foundation for instilling ethical conduct in business. Among these teachings, ṢAṬ PĀRAMITĀ (the Six Perfections)—which include Generosity (Dāna), Ethical Conduct (Śīla), Patience (Kṣānti), Diligence (Vīrya), Meditation (Dhyāna), and Wisdom (Prajñā)—represent a path toward moral and ethical behavior (Harvey, 2000; Dharmasiri, 1986). These virtues, long practiced within Vietnamese culture through community and religious practices, provide insights into building a robust business ethical framework (Anh et al., 2024). By embedding these values into business practices, Vietnamese enterprises can harmonize economic success and social responsibility.

In Vietnam, integrating traditional values into modern practices is not new. Business ethics have evolved alongside the country's rapid economic growth, particularly after the *Đổi Mới* (Renovation) policy initiated in 1986, and this period marked Vietnam's transition from a centrally planned economy to a market-oriented one, bringing both opportunities and ethical challenges (Nam & Thanh, 2024). The shift highlighted the need for strong ethical practices to prevent corruption, exploitation, and loss of public trust (Jayatilleke, 1984).

Research on applying Buddhist principles in business is supported by studies showing that many Vietnamese entrepreneurs and business leaders seek to align their work with personal and cultural values rooted in Buddhism. For instance, a Vietnam Buddhist Research Institute survey indicates that business leaders who incorporate Buddhist ethics into their management styles report higher employee satisfaction and loyalty. This aligns with findings from other global studies suggesting that ethical business practices lead to long-term sustainability and stakeholder trust (Nguyen et al., 2024).

The objective of this research is to analyze the core values of ṢAṬ PĀRAMITĀ and assess their potential applications in building and enhancing business ethics among Vietnamese entrepreneurs. This paper bridges traditional philosophical wisdom with contemporary business practices by showcasing how the Six Perfections can guide ethical decision-making and corporate behavior. The study employs a theoretical research approach, encompassing a comprehensive literature review of Buddhist teachings and existing models of ethical business practices (ICDV; 2011). To enrich this foundation, the research also incorporates analysis of case studies specific to Vietnamese businesses. This includes examples of how local enterprises have adopted these teachings, either

Ṣaṭ Pāramitā and its Application Values in Building Ethics of Vietnamese Business People Today

formally or informally, to guide ethical practices. The qualitative nature of this approach ensures a thorough understanding of both the philosophical aspects of ṢAṬ PĀRAMITĀ and their practical applications in today's business environment. The study draws insights from documented business practices, interviews with Vietnamese business leaders, and relevant literature that connects ethical theory with corporate implementation.

2. THEORETICAL FRAMEWORK

ṢAṬ PĀRAMITĀ, known as the Six Perfections, forms a cornerstone of Mahayana Buddhist teachings, encapsulating essential virtues that guide individuals toward moral and spiritual growth. These virtues—Dāna (Generosity), Śīla (Ethical Conduct), Kṣānti (Patience), Vīrya (Diligence), Dhyāna (Meditation), and Prajñā (Wisdom)—emphasize actions that enhance personal development and contribute to communal well-being (Dharmasiri, 1986). Each virtue provides a framework that can be seamlessly integrated into modern business ethics to create a culture of integrity, accountability, and societal contribution.

Dāna represents the ideal of selfless giving, extending beyond material contributions to encompass time, knowledge, and compassion. In a corporate context, Dāna aligns with corporate social responsibility (CSR) and philanthropy principles (Harvey & Peter, 2000). Companies embracing Dāna through CSR initiatives foster stronger relationships with stakeholders and local communities, enhancing their social capital. Vietnamese businesses exemplify this virtue through community-centric programs, funding educational projects, supporting regional development, and nurturing inclusive workplace cultures. Empirical evidence shows that Vietnamese enterprises with robust CSR practices often experience greater customer loyalty and community support, reinforcing that generosity builds trust and long-term success.

Śīla, or ethical conduct, embodies adherence to moral principles and is fundamental for maintaining trust and integrity. In the business environment, Śīla involves compliance with laws, the equitable treatment of employees, and transparent interactions with clients (Saddhatissa & Hammalawa, 1987; Tachibana, 1986). Integrating Śīla into business operations ensures ethical behavior becomes an organizational norm, helping mitigate risks such as corruption and fostering sustainable partnerships (Jayatilleke et al., 1972, 1984). Research indicates that Vietnamese companies prioritizing ethical conduct achieve better stability and growth, underpinned by solid reputational standing.

Kṣānti emphasizes patience, tolerance, and resilience in the face of adversity. This virtue is critical for leaders navigating business conflicts, crises, and economic fluctuations (Kalupahana & David, 1995). Companies embodying Kṣānti maintain a steady course through challenges, preserving team morale and fostering a climate of trust. The cultural importance of patience in Vietnam underscores its relevance in leadership and decision-making, where thoughtful responses to challenges contribute to sustainable outcomes.

Vīrya, representing diligence and persistent effort, resonates with the contemporary emphasis on continuous improvement and corporate integrity. It highlights the importance of sustained, ethical efforts toward long-term objectives. Vietnam's rapid economic growth, mainly since the "Đổi Mới" reforms, showcases the value of diligence as a driver of business resilience. Companies that uphold Vīrya remain competitive by continuously adapting to economic changes and fostering innovation.

Dhyāna pertains to mindfulness and mental clarity, facilitating focused decision-making free from impulsive reactions. Modern organizations increasingly incorporate mindfulness to enhance leadership effectiveness and improve workplace culture. Vietnamese business leaders practicing Dhyāna report benefits such as reduced stress, better strategic thinking, and enhanced problem-solving. This virtue helps businesses approach complex situations clearly, ensuring decisions are aligned with long-term ethical goals.

Prajñā, the cultivation of wisdom, guides ethical strategy and leadership. In business, wisdom involves considering diverse perspectives and making informed, balanced decisions that account for profit and societal impact (Keown & Damien, 1992). In Vietnam, where collective welfare is deeply valued, applying Prajñā means choosing actions that benefit the company and its broader community. Research shows that Vietnamese enterprises led by individuals who prioritize wisdom often achieve better reputations and long-term stability.

Integrating these virtues with modern ethical frameworks reveals a strong alignment between ancient teachings and contemporary expectations (Misra, 1995). Business ethics, encompassing principles such as transparency, fairness, and responsibility, resonate with the moral guidelines provided by ṢAṬ PĀRAMITĀ. These virtues are applied within Vietnamese enterprises in CSR efforts, ethical leadership practices, and initiatives that promote community well-being. For instance, significant corporations like VinGroup and FPT Corporation illustrate the application of Dāna through sustained social projects that support education, healthcare, and environmental conservation.

Business ethics in Vietnam extend beyond compliance with regulations, embracing cultural values rooted in mutual support and communal welfare. This connection bridges traditional ethical teachings and modern business strategies, creating a framework where companies can thrive while adhering to ethical norms. Empirical data supports this alignment; studies by the Vietnam

Ṣaṭ Pāramitā and its Application Values in Building Ethics of Vietnamese Business People Today

Chamber of Commerce and Industry (VCCI) and the Vietnam Institute of Business Ethics highlight that ethical practices enhance employee satisfaction, increase stakeholder trust, and build resilience against market challenges.

Embedding ṢAṬ PĀRAMITĀ in business strategies not only aligns with the global move toward responsible leadership but also enriches the company culture by integrating time-honored values (Ratnapala & Nandasena,1993). The virtues encourage business leaders to approach their roles with integrity, fostering a holistic ethical framework that sustains growth and societal prosperity.

3. APPLICATION OF ṢAṬ PĀRAMITĀ IN BUILDING BUSINESS ETHICS

ṢAṬ PĀRAMITĀ, known as the Six Perfections, forms a significant foundation in Mahayana Buddhism, embodying essential virtues that guide individuals toward moral excellence and collective well-being. These virtues, including Dāna (Generosity), Śīla (Ethical Conduct), Kṣānti (Patience), Vīrya (Diligence), Dhyāna (Meditation), and Prajñā (Wisdom), present a profound framework for both personal development and ethical business conduct. Integrating these values within a modern corporate context offers a comprehensive approach to fostering trust, integrity, and long-term success.

Generosity, or Dāna, extends beyond simple acts of monetary giving and encapsulates the contribution of time, knowledge, and resources to create positive impacts within the community. In the business world, this principle parallels corporate social responsibility (CSR) and philanthropic activities that enhance the social and environmental landscape. Companies that practice Dāna through strategic CSR initiatives often build stronger community ties and stakeholder trust. In Vietnam, where the cultural ethos emphasizes "tương thân tương ái" (mutual aid), applying Dāna aligns with the societal focus on collective welfare. This cultural alignment makes the integration of generosity in business practices both effective and resonant.

Vietnamese enterprises provide numerous examples of how the principle of Dāna is reflected in practice. VinGroup, a major conglomerate in Vietnam, has established a reputation for robust CSR programs that support educational opportunities, healthcare access, and scientific advancement through initiatives like the VinGroup Innovation Foundation. These efforts highlight the group's commitment to societal progress, illustrating that Dāna in business can yield tangible benefits, including increased customer loyalty and enhanced brand reputation.

FPT Corporation serves as another case in point. Known for its ongoing engagement in charitable activities and community development, FPT's CSR initiatives span from technology training for youth and disaster response efforts to fostering STEM education in rural areas. These programs showcase how businesses can leverage their expertise and resources to advance societal welfare, reinforcing their standing as responsible and ethical entities.

TH Group, recognized for its sustainable agricultural practices, incorporates environmental consciousness into its CSR strategy, investing in eco-friendly production methods and health-oriented community programs. Their efforts to ensure clean drinking water and health services for underprivileged regions underscore the breadth of Dāna, demonstrating that corporate generosity can significantly enhance public welfare.

Hoang Anh Gia Lai Group (HAGL) exemplifies the application of Dāna through its investments in social welfare projects in the Central Highlands, such as constructing schools, hospitals, and affordable housing. Such initiatives contribute to immediate needs and foster sustainable community growth, showcasing how corporate efforts aligned with Dāna can help address regional inequalities and elevate the quality of life.

Empirical studies in Vietnam corroborate the value of CSR initiatives as reflections of Dāna. The Vietnam Chamber of Commerce and Industry (VCCI) reports that approximately 75% of companies engaged in CSR activities have experienced enhanced public trust and stronger community relationships. This positive correlation underscores that corporate generosity not only fulfills a moral imperative but also promotes business resilience and growth. Furthermore, research from the Vietnam Institute of Business Ethics and Corporate Governance reveals that employees at companies known for their generous practices show higher job satisfaction and commitment. This finding suggests that Dāna can profoundly influence internal company culture, fostering a shared purpose and aligning with broader ethical values.

The virtue of Śīla, or ethical conduct, underscores the importance of adherence to moral principles, transparency, and compliance with regulations. Practicing Śīla involves maintaining integrity in all interactions and ensuring that company policies reflect fairness and respect. Implementing this virtue strengthens an organization's reputation and establishes trust with clients, partners, and employees. For Vietnamese businesses, where corruption and regulatory challenges persist, integrating Śīla into corporate operations helps mitigate risks and fosters long-term partnerships.

Kṣānti, the practice of patience and resilience, is particularly relevant for business leaders and employees dealing with conflicts and navigating complex challenges. Leaders who exhibit patience can manage crises more effectively and make decisions that prioritize long-term outcomes over immediate gains. Historical and contemporary examples in Vietnam underscore that patience is a valued trait, allowing leaders to maintain composure and thoughtfully guide their teams through adversity. Companies that

Ṣaṭ Pāramitā and its Application Values in Building Ethics of Vietnamese Business People Today

embrace Kṣānti are better positioned to handle market fluctuations and internal disruptions, maintaining morale and strategic focus.

Vīrya, the embodiment of diligence, is committed to continuous effort and dedication to achieving ethical and productive goals. The value of relentless effort is echoed in Vietnamese business practices, particularly in the context of the economic reforms post-Đổi Mới, where diligence has been essential for entrepreneurs adapting to market shifts. Businesses that demonstrate Vīrya often sustain their competitive edge through consistent innovation and improvement, underpinning a high standards and responsibility culture.

Dhyāna, which focuses on mindfulness and mental clarity, translates into strategic concentration and improved decision-making in business settings. Dhyāna leaders are equipped to manage stress and make measured decisions, enhancing personal effectiveness and corporate culture. In Vietnam, incorporating mindfulness practices has gained traction among business leaders, improving productivity and reducing workplace stress. Adopting Dhyāna encourages a balanced approach to challenges, fostering a work environment conducive to thoughtful and ethical decision-making.

Prajñā, cultivating wisdom, is crucial in guiding leaders to make informed and balanced decisions. Wisdom in business encompasses the ability to view challenges from multiple perspectives, enabling leaders to devise ethical and beneficial solutions for all stakeholders. In the Vietnamese business context, where communal values often intertwine with corporate objectives, applying Prajñā means making choices that support the company and its broader social environment. Case studies indicate leaders prioritizing wisdom in their decision-making processes contribute to a culture of innovation, resilience, and ethical sustainability. Integrating the Six Perfections into business practices establishes a comprehensive framework that enriches ethical standards, enhances community engagement, and promotes long-term corporate success. Vietnamese enterprises that embrace these virtues find themselves aligned with modern corporate responsibility expectations and traditional values that emphasize mutual support and integrity. This integration bridges historical moral teachings with contemporary business ethics, positioning companies as leaders in ethical innovation and contributors to societal well-being.

4. DISCUSSION

Incorporating the virtues of ṢAṬ PĀRAMITĀ into modern business practices has been shown to yield significant positive impacts. One of the foremost benefits is enhancing trust between a company and its stakeholders, including customers, employees, and the wider community. Trust is an invaluable asset in business, leading to stronger brand loyalty, improved stakeholder relationships, and a more favorable reputation. By practicing virtues such as Dāna (Generosity) and Śīla (Ethical Conduct), businesses demonstrate their commitment to ethical values and social responsibility, reinforcing public confidence in their operations. This, in turn, translates into sustainable growth as companies build long-term relationships that support continuous development and resilience.

Sustainable growth is another prominent outcome of integrating these virtues. Businesses that prioritize ethics and social contribution often find that their operations are more stable and adaptable to changing market conditions. For example, companies incorporating Kṣānti (Patience) and Vīrya (Diligence) tend to weather economic downturns and crises more effectively by maintaining strategic focus and nurturing team morale. These virtues support a culture of perseverance and long-term thinking, which is critical for navigating challenges without sacrificing ethical principles.

However, integrating ṢAṬ PĀRAMITĀ into modern business practices is not without its challenges. One significant obstacle is resistance to change. Shifting corporate culture to embrace these traditional virtues can be met with hesitation, especially in organizations where profit maximization and rapid growth are prioritized over long-term sustainability and ethical considerations. Employees and management may struggle with adopting a more value-based approach if perceived as conflicting with established business norms or strategies.

The complexity of embedding traditional values within contemporary business frameworks also presents challenges. Applying virtues like Dhyāna (Meditation) and Prajñā (Wisdom) requires more than a superficial adjustment; it fundamentally changes how business leaders and employees approach decision-making and daily operations. This transition often demands comprehensive training, the redesign of internal processes, and a shift in performance metrics to include financial outcomes and ethical and social contributions. Ensuring these changes are sustainable requires a deep understanding of traditional teachings and their relevance to modern business practices.

Despite these challenges, the benefits of incorporating ṢAṬ PĀRAMITĀ outweigh the difficulties, particularly within the context of Vietnamese culture. The practice of Dāna resonates with the cultural emphasis on “tương thân tương ái” (mutual aid), which has long been a part of Vietnam’s social fabric. By aligning business practices with these culturally ingrained values, companies can foster a stronger connection with their workforce and communities, reinforcing a sense of shared purpose. This cultural alignment enhances the effectiveness of CSR initiatives and other ethical practices, making them more genuine and impactful.

Ṣaṭ Pāramitā and its Application Values in Building Ethics of Vietnamese Business People Today

When comparing ṢAṬ PĀRAMITĀ with other global ethical frameworks, its unique focus on holistic growth and personal development stands out. Western ethical models, such as those based on utilitarianism or deontological principles, often emphasize outcome-based or rule-based ethics. While effective in promoting fairness and justice, these frameworks can sometimes overlook the importance of personal virtues and moral character in shaping ethical behavior. In contrast, ṢAṬ PĀRAMITĀ places a significant emphasis on the cultivation of internal virtues that inherently lead to ethical actions, bridging personal and professional development. This approach fosters an environment where ethical behavior stems from individuals' commitment to moral excellence, not just adherence to external rules.

In Vietnam, this distinction is particularly beneficial. Integrating personal virtues like Dhyāna and Prajñā into business practices encourages leaders to make decisions considering long-term community welfare, aligning with the country's collectivist cultural values. This contrasts with many Western frameworks that may prioritize individual success or short-term outcomes over collective benefits. By promoting meditation and mindfulness (Dhyāna), businesses can cultivate leaders who approach complex challenges with clarity and balanced perspectives, leading to strategic and ethical decisions.

Adopting virtues such as Kṣānti (Patience) is also crucial in Vietnam's business environment, which often involves navigating intricate relationships and regional dynamics. Unlike more rigid ethical codes found in global frameworks, the emphasis on patience and tolerance allows Vietnamese businesses to handle negotiations and conflicts that respect local customs and promote harmony.

Ultimately, integrating ṢAṬ PĀRAMITĀ into Vietnamese business practices offers a multifaceted approach to ethics that aligns with national cultural values while addressing the needs of a modern economy. This blend of traditional wisdom and contemporary application supports a business model that thrives economically and contributes positively to society, reinforcing Vietnam's position as an example of how ancient teachings can inform and enhance modern corporate ethics. The challenge remains in effectively balancing these practices with the realities of competitive business, but the potential for sustainable growth and deep-rooted trust makes the pursuit worthwhile.

5. CONCLUSION AND RECOMMENDATIONS

The analysis of ṢAṬ PĀRAMITĀ and its application in modern business practices highlights its profound contribution to fostering ethical behavior. The Six Perfections—Dāna (Generosity), Śīla (Ethical Conduct), Kṣānti (Patience), Vīrya (Diligence), Dhyāna (Meditation), and Prajñā (Wisdom)—serve as guiding principles that enhance personal and collective ethical standards. These virtues support individual growth and contribute to creating a corporate culture founded on integrity, resilience, and social responsibility. By embedding these values into business practices, Vietnamese enterprises can build trust, ensure long-term sustainability, and maintain their competitive edge while adhering to high moral standards.

Dāna facilitates the development of corporate social responsibility programs and philanthropy that strengthen community relationships and foster loyalty. Śīla emphasizes the importance of integrity and adherence to ethical principles, enhancing transparency and building market trust. Kṣānti instills resilience and patience, enabling companies to navigate challenges with composure and prudence. Vīrya underscores the necessity of consistent effort and perseverance, fostering an organizational culture that values continuous improvement and accountability. Dhyāna enhances strategic thinking and mindfulness, leading to well-considered decision-making that avoids impulsive errors. Prajñā equips leaders with the wisdom needed to balance profit-driven motives with long-term, ethical decision-making, ensuring that business strategies benefit the company and the broader community.

To ensure that these virtues are effectively integrated into Vietnamese business practices, actionable steps can be taken by business leaders and policymakers. Training programs should be designed to instill the Six Perfections as part of corporate culture, focusing on workshops that teach how these values can be practically applied to everyday business situations. Leadership development programs should include modules on ethical decision-making rooted in Dhyāna and Prajñā, equipping leaders with the mindfulness and insight necessary for complex problem-solving and strategic planning. Moreover, corporate policies should be revised to reflect these virtues, establishing behavior and decision-making standards that align with ethical practices and business objectives.

Policymakers can play a pivotal role by encouraging the integration of these values through regulatory support and incentives for companies that demonstrate a commitment to ethical behavior rooted in traditional virtues. This could include recognition programs or tax benefits for businesses that show leadership in CSR and other initiatives that promote community welfare.

Future research should include quantitative studies to provide a more comprehensive understanding of how these virtues impact business performance. Empirical investigations that measure the effects of applying Buddhist virtues on various performance metrics, such as employee retention, customer satisfaction, and financial stability, would provide valuable insights. These studies

Ṣaṭ Pāramitā and its Application Values in Building Ethics of Vietnamese Business People Today

could validate the benefits observed in qualitative analyses and offer a more data-driven basis for advocating the integration of ṢAṬ PĀRAMITĀ into business practices.

Furthermore, conducting longitudinal studies to track changes in organizations that incorporate these virtues would yield insights into their long-term benefits and potential challenges. By combining traditional ethical teachings with empirical research, Vietnamese businesses can create a balanced approach that respects cultural values while remaining adaptable to modern economic demands. This integration can position Vietnam as a model for how ancient wisdom can inform and elevate contemporary business ethics, fostering a sustainable and ethically driven economic landscape.

REFERENCES

- 1) Buddhist Virtues in Socio-Economic Development (ICDV) – The 8th International Buddhist Conference on the United Nations Day of Vesak Celebrations (2011, Thailand).
- 2) Dharmasiri, G. (1986). *Fundamentals of Buddhist Ethics*. Singapore: Buddhist Research Society.
- 3) Harvey, Peter (2000). *An Introduction to Buddhist Ethics: Foundations, Values and Issues*. Cambridge: Cambridge University Press.
- 4) Jayatilleke, K.N., *Ethics in Buddhist Perspective* (1972, 1984). Kandy: Buddhist Publication Society.
- 5) Kalupahana, David J. (1995). *Ethics in Early Buddhism*. Honolulu: Library of Congress Cataloging-in-Publication Data.
- 6) Keown, Damien (1992). *The Nature of Buddhist Ethics*. London: Macmillan.
- 7) Misra, G. S. P. (1995). *Development of Buddhist Ethics*. Delhi: Munshiram Manoharlal Publishers.
- 8) Ratnapala, Nandasena (1993). *Crime and Punishment in the Buddhist Tradition*. New Delhi: K.M. Rai Mittal for Mittal Publications.
- 9) Saddhatissa, Hammalawa (1987). *Buddhist Ethics - The Path to Nirvana*. London: Wisdom Publications.
- 10) Tachibana, S. (1986). *The Ethics of Buddhism*. Delhi: Cosmo Publications.
- 11) Thanh, N. N., Thuy, N. T., Thao, B. T., & Huong, H. T. T. (2023). Policies for Religious and the Practice of Burning Votive Papers for the deceased: a survey in Vietnam. *Synesis* (ISSN 1984-6754), 15(2), 208-222.
- 12) Tung, P. H., Hang, T. T. T., Huong, T. T. M., Hop, N. T., & Thanh, N. N. (2021). Mindfulness Adjusts the Relationship between Vocabulary Retention and Foreign Language" Learning" Efficiency: A Preliminary'Survey on Non-English Major'Vietnamese'Students. *Rigeo*, 11(8).
- 13) Anh, T. T. T., Anh, T. T. L., & Thanh, N. N. (2024). The impact of green tourism on the Hmong community in Vietnam. *Multidisciplinary Science Journal*, 6(4), 2024034-2024034.
- 14) Nam, N. T., & Thanh, N. N. (2024). Examining economic incentives and youth engagement in cultural heritage conservation for tourism and sustainable development: A case study of cultural provinces in Vietnam. *Asian Development Policy Review*, 12(2), 177-193.
- 15) Nguyen, T. D., Nguyen, N. T., & Thanh, N. N. (2024). Factors Affecting Sustainable Tourism Development: Evidence from the Central Highlands of Vietnam. *SAGE Open*, 14(2), 21582440241240816.



There is an Open Access article, distributed under the term of the Creative Commons Attribution – Non Commercial 4.0 International (CC BY-NC 4.0) (<https://creativecommons.org/licenses/by-nc/4.0/>), which permits remixing, adapting and building upon the work for non-commercial use, provided the original work is properly cited.

Maternal Health Service Utilization and Women's Health Care Decision-Making Autonomy in Ethiopia



Nasser B. Ebrahim

Department of Public Health, Keimyung University, Daegu, South Korea

ABSTRACT: Maternal health service utilization and its association with women's health care decision-making autonomy were examined from a nationally representative sample. Adequate use of maternal health services is critical in maintaining the well-being and health of mothers and prevent maternal and neonatal mortalities. Women's health care decision-making autonomy has been cited to influence the uptake of maternal services among women in resource-poor countries. A secondary data collected in 2016 by Demographic and Health Survey, Ethiopia, was used. Three maternal health services measurement indicators and their associations with women health decision-making autonomy were examined (number of prenatal visits, birth attended by skilled health personnel, and delivery at health facilities) from a sample of women aged 15-49 years (n=11023) were included. SPSS ver. 27 was used to analyze the data after taking into account survey design effects and sampling weights. Results showed that maternal health utilization services in the study population was inadequate. However, the association between women's health care decision-making autonomy and births attended by skilled health care professionals and birthing at health care facilities were significant. The significant and positive association between women's health care decision-making autonomy and the two critical maternal health services (access to skilled birth attendants and delivery at health facilities) may indicate that enhancing women's autonomy could have a potential to reduce maternal mortalities among Ethiopian women.

KEYWORDS: Women, maternal health services, health care decision-making autonomy, Africa, Ethiopia

I. INTRODUCTION

Access to and the utilization of maternal health services are critical in maintaining the health and wellbeing of mothers and their newborns. Maternal mortality defined as the number of deaths caused or worsened by pregnancy (WHOa, n. d.) and is an important global health issue (WHO, 2024). In 2020 alone, 287 000 maternal deaths related to pregnancy and childbirth were reported (WHO, 2024). The burden of maternal mortality, however, is not uniformly distributed across the world as women from developing countries account for 95% of all maternal deaths globally (WHO, 2024). Specifically, bearing the brunt were women from subSaharan Africa, who accounted for 70% of all maternal mortalities in the world in 2020 (WHO, 2024).

According to the United Nations Population Fund (n. d.) although maternal mortality rate has declined over the years in Ethiopia, it currently stands at 267 maternal deaths per 100,000 live births, far higher than the target of the sustainable development goal of 70 deaths per 100, 000 live births (United Nations Population Fund, n. d.; WHO, 2024).

Women's autonomy and empowerment have garnered significant interest around the world because of its relevance to women's human rights and its impact on health service uptake (Kishor & Gupta, 2019; Lee, Kumar, Al-Nimr, 2017). Specially, in patriarchal societies, women's lower social position put them at a disadvantage in accessing resources, including health services (Sado, Spaho, & Hotchkiss, 2014). Ability to utilize health care services, among other factors, may be related to women's decision-making autonomy (Osamo & Grady, 2016). It particularly resonates with women living in developing nations because women's lower status limits their independence and abilities to make decisions, affecting their lives including the use of health care services (Osamo & Grady, 2016). Health care decision making encompasses the ability and freedom to make decision for oneself and their dependents in matters related to health care service utilization (Dyson & Moore, 2016). The assumption why women's autonomy is considered pertinent in affecting maternal health service utilization is that highly independent women can make decisions related to use and utilize health care services that could impact their lives (Ameyaw et al., 2016). However, several research findings from developing nations had shown inconsistencies in the relationship between the use of maternal health services and women's autonomy to making decisions in diverse women populations (Kamiya, 2011; Khatir et al., 2024; Moyer et al., 2014;

Maternal Health Service Utilization and Women's Health Care Decision-Making Autonomy in Ethiopia

Rizkianti et al., 2020) and might be context dependent. The current study, which is based on a nationally representative sample, may provide valuable information specific to Ethiopian with the purpose of examining the association between births attended by skilled health personnel, prenatal care, and birthing at health facilities and women's health care decision making independence.

II. METHODS

Sample Design

The study is cross-sectional in which secondary data collected in 2016 by Demographic and Health Survey, Ethiopia, was used. The data had numerous socio-demographic and health measures (Central Statistical Agency (CSA) [Ethiopia] and ICF International, 2017). The sampling method employed was a two-step stratified cluster sampling that included participants from rural and urban areas (Central Statistical Agency (CSA) [Ethiopia] and ICF International, 2017). During the data collection phase, the safety of study participants was ensured by following the guidance of World Health Organization and the data collection procedure was approved by the relevant institutions (Central Statistical Agency (CSA) [Ethiopia] and ICF International, 2017). Data set under children in EDHS-2016 that included responses from a sample of women who gave live births in the five years before the survey and who aged 15-49 years (n=11023) were used in the analysis.

Measurements

Three variables (frequency of prenatal care visits for the recent live births, birth attended by skilled health personnel and child delivery place (home vs health facility) were used as maternal health services indicators. The frequency of prenatal care visits was dichotomized as "0" for 0 to 3 visits of prenatal care visits during the pregnancy, and "1" for 4 or more prenatal care visits during pregnancy (at least four prenatal visits are considered adequate coverage per WHO) (WHO, n. d.). Births attended by skilled health personnel (doctors, nurses, midwives, health officers, and health extension workers) were coded "1" and "0" if births were not attended by skilled health personnel. Birthing at health facility was coded "1" and birthing at home coded "0." The main explanatory variable, women's health care decision-making autonomy, was assessed from this question: Who usually decides on respondent's health care? (1) respondent only, (2) respondent and husband/partner, (3) respondent and other persons, (4) husband or partner alone, (5) someone else and (6) others. Women who responded that the decision on health care is made only by the respondent were deemed as having high level of independence in making health care decisions (high health decision-making autonomy) and coded "1" and other responses were coded as "0" and deemed to have low level of making health care decisions (low health care decision-making autonomy).

Data Analysis

Complex survey analysis module in SPSS ver. 27.0 was used to analyze the data after taking into account survey design effects and sampling weights. From the summary of descriptive statistics, prevalence of maternal health service utilization in the study population was assessed. The relationships between maternal health service measures and women health care decision autonomy were estimated by multivariate logistic regression models, adjusting for socio-demographic variables such as age, residence type, wealth index, level of education and employment status. Statistical significance was determined using a p-value of less than 0.05.

III. RESULTS

Among women in the study sample, only 13%, 95% CI=11.8, 14.4, had shown high level of health care decision-making autonomy as the vast majority, 87%, 95% CI=85.6, 88.2 had low health care decision-making autonomy. As well, only one-in-three women (31.9%, 95% CI=29.6, 34.2) had four prenatal visits for their recent live births while 27.7%, 95% CI=24.9, 30.7, of women who reported live births, were assisted by skilled health personnel during child birth. Among women who had live births, only 27.4%, 95% CI=24.7, 60.4, gave birth at health facilities (Table 1). In the multivariate analysis, the association between women's health care decision-autonomy and prenatal visits was not significant. However, the association between health care decision-making independence (autonomy) and births attended by skilled health personnel was significant and so for birthing at health care as well (Table 2).

Table 1. Prevalence of maternal health services and women's health decision-making autonomy

Maternal health service utilization & Women's health care decision-making autonomy	N	Estimate %	95% Confidence interval
Number of prenatal visits* 0-3	5160	68.1	65.8-70.4
4+	2415	31.9	29.6-34.2

Maternal Health Service Utilization and Women's Health Care Decision-Making Autonomy in Ethiopia

Total	7575	100	-
Births attended by skilled health personnel †			
Yes			
	3053	27.7	24.9-30.7
No	7970	72.3	69.3-75.1
Total	11023	100	-
Delivery place			
Health facility	3026	27.4	24.7-60.4
Home	7997	72.6	69.6-75.3
Total	11023	100	-
Women health decision-making autonomy‡			
Low	9100	87.0	85.6-88.2
High	1362	13.0	11.8-14.4
Total	10462	100	-

* Number of prenatal visit for the most recent live births, †= Live births in the five years before the survey. ‡=For all women, 15-49 years of age. Numbers were weighted.

Table 2. Adjusted odd-ratios (OR) and 95% confidence interval (CI): Women's health decision-making autonomy and maternal health service utilization

Variable	Prenatal visits†		Birth attended by skilled health personnel		Birthing at health facility	
	OR	95%CI	OR	95%CI	OR	95%CI
Health decision making autonomy						
Low	1		1		1	
High	1.17	.94-1.45	1.33*	1.09-1.63	1.27*	1.04-1.55

Adjusted for women's age, residence type, wealth index, educational level and employment status. *p<0.05. †=four or more prenatal visits.

IV. DISCUSSION

Overall, the overwhelming majority (87%) of women in the study sample had low level of making independent health care decisions. The lower level of decision-making independence (autonomy) in matters related to their health and other family issues among women have previously been reported [(Kashahun & Zewdie, 2022; Tesfa et al., 2022; USAID, 2012). Similarly, reports showed that women in many sub-Saharan African countries also have low level of decision-making autonomy (Adriano Behrman, & Monden, 2021; Sougou et al., 2017). Women who have low level of autonomy in making decisions may encounter difficulties in accessing health services (Imo, 2022), thus, enhancing women's autonomy could improve mothers' and children's well-being as well as the adoption of reproductive health services (Rahman, Mostofa, & Hoque, 2014; Saaka, 2020; Salvador & Ebrahim, 2024). Among study participants, only 32% of women had four or more prenatal visits. More recent report, however, have shown 43% of women had four or more prenatal (Ethiopian Public Health Institute [Ethiopia] and ICF, 2021). In contrast, 84.5% of Filipino women had four or more prenatal visits for their recent live births (Salvador & Ebrahim, 2024). Similar lower coverage of prenatal visits has been reported for women in Western and Central Africa (UNICEF, 2024) As well, only 27.7% of women received the assistance of health personnel during birthing, although the proportion has increased to 50% in recent years (Ethiopian Public Health Institute [Ethiopia] and ICF, 2021). Skilled health personnel are professional who are trained to recognize complications that may endanger mothers and their newborns and take actions that can save the lives thus, access to skilled birth attendant is critical in reducing maternal mortality (UNICEF, 2022). However, wide variations in medical skills exist among health professionals providing maternal services in Ethiopia (for example, extension health workers are considered skilled birth attendants), nonetheless, coverage is still far below the average (64%) for sub-Saharan African region (UNICEF, 2022). Mirroring

Maternal Health Service Utilization and Women's Health Care Decision-Making Autonomy in Ethiopia

the low coverage of prenatal visits and professional birth attendants, the proportion of women who delivered at health facilities was only 27.4% in the study sample, but the coverage has increased, and in recent years, almost half of women delivered at health facilities (Ethiopian Public Health Institute [Ethiopia] and ICF, 2021), although wide variations are observed among health care facilities in providing comprehensive labor and birthing care in Ethiopia (Bayou et al., 2022).

Results from the multivariate analysis have shown that women with high level of health decisionmaking autonomy had significantly higher odds of receiving assistance from health care professionals during birthing process and deliver their babies at health care facilities. Women's health care decision-making autonomy (independence in making decisions related to health matters) may play a valuable role in improving women's use of maternal health services. The results agree well with previous studies from various women populations in sub-Saharan Africa (Ameyaw et al., 2016; Dickson, 2021; Sougou et al., 2020). Given the low prevalence of maternal health service use in Ethiopia, the significant association between access to critical maternal health services (such as births attended by health professional and giving birth at health facilities) and health care decision-making autonomy, may mediate their uptake and ultimately help reduce maternal mortalities. Enhancing women's independence could be achieved through women's economic empowerment, which is instrumental in fostering independence in making decisions that benefit them (UN Women, n. d.).

V. CONCLUSION

The use of maternal health services examined in the study population were inadequate and need improvements. The significant and positive association of women's health care decision-making autonomy with the two critical maternal health services (access to skilled birth attendants and delivery at health facilities) may indicate its potential role in reducing maternal mortality. Thus, enhancing women's independence in making decisions about their health could be one of the pathways to improving the adoption of maternal services in the study population.

REFERENCES

- 1) Ameyaw, E. K., Tanle, A., Kissah-Korsah, K., & Amo-Adjei, J. (2016). Women's Health Decision-Making Autonomy and Skilled Birth Attendance in Ghana. *International Journal of Reproductive Medicine*, 2016(1), 6569514. <https://doi.org/10.1155/2016/6569514>.
- 2) Andriano, L., Behrman, J., & Monden, C. (2021). Husbands' dominance in decision-making about women's health: A spatial diffusion perspective in Sub-Saharan Africa. *Demography*, 58(5), 1955-1975. <https://doi.org/10.1215/00703370-9429489>.
- 3) Bayou, N. B., Grant, L., Riley, S. C., & Bradley, E. H. (2022). Structural quality of labor and delivery care in government hospitals of Ethiopia: a descriptive analysis. *BMC Pregnancy and Childbirth*, 22(1), 523. <https://doi.org/10.1186/s12884-022-04850-5>.
- 4) Central Statistical Agency (CSA) [Ethiopia] and ICF International (2017). Ethiopia Demographic and Health Survey 2016. Addis Ababa, Ethiopia, and Rockville, Maryland, USA: CSA and ICF International [Internet]. 2017 Jul; [cited 2024 Sept 8]. Available from: <https://dhsprogram.com/pubs/pdf/FR328/FR328.pdf>.
- 5) Dickson, K. S. (2021). Women empowerment and skilled birth attendants among women in rural Ghana. *BioMed Research International*, 2021(1), 9914027. DOI: 10.1155/2021/9914027.
- 6) Dyson, T., & Moore, M. (1983). On kinship structure, female autonomy, and demographic behavior in India. *Population and Development Review*, 35-60. <https://doi.org/10.2307/1972894>.
- 7) Ethiopian Public Health Institute (EPHI) [Ethiopia] and ICF (2021). Ethiopia Mini Demographic and Health Survey 2019: Final Report. Rockville, Maryland, USA: EPHI and ICF, 2021 May; [cited 2024 Sept 22]. Available from: <https://dhsprogram.com/pubs/pdf/FR363/FR363.pdf>.
- 8) Imo, C. K. (2022). Influence of women's decision-making autonomy on antenatal care utilisation and institutional delivery services in Nigeria: evidence from the Nigeria Demographic and Health Survey 2018. *BMC Pregnancy and Childbirth*, 22(1), 141. <https://doi.org/10.1186/s12884-022-04478-5>.
- 9) Kamiya, Y. (2011). Women's autonomy and reproductive health care utilisation: empirical evidence from Tajikistan. *Health Policy*, 102(2-3), 304-313. Doi: 10.1016/j.healthpol.2011.04.001.
- 10) Khatir, A. G., Wang, T., Ariyo, T., Rahman, N., & Jiang, Q. (2024). Women's healthcare autonomy and the utilization of maternal healthcare services in Afghanistan. *Public Health*, 235, 49-55. <https://doi.org/10.1016/j.puhe.2024.06.021>.
- 11) Kishor, S., Gupta, K (2009). Gender equality and women's empowerment in India [Internet]. Ministry of Health and Family Welfare Government of India. International Institute for Population Sciences; [cited 2024 Sep 16]. Available from: <https://dhsprogram.com/pubs/pdf/OD57/OD57.pdf>.

Maternal Health Service Utilization and Women's Health Care Decision-Making Autonomy in Ethiopia

- 12) Lee, R., Kumar, J., & Al-Nimr, A. (2017). Women's healthcare decision-making autonomy by wealth quintile from Demographic and Health Surveys (DHS) in sub-Saharan African countries. *International Journal of Women's Health and Wellness*, 3(054), 2474-1353. <https://doi.org/10.23937/2474-1353/1510054>.
- 13) Kassahun, A., & Zewdie, A. (2022). Decision-making autonomy in maternal health service use and associated factors among women in Mettu District, Southwest Ethiopia: a community-based cross-sectional study. *BMJ Open*, 12(5), e059307. Doi: 10.1136/bmjopen-2021-059307.
- 14) Moyer, C. A., Adongo, P. B., Aborigo, R. A., Hodgson, A., Engmann, C. M., & DeVries, R. (2014). "It's up to the woman's people": how social factors influence facility-based delivery in Rural Northern Ghana. *Maternal and Child Health Journal*, 18, 109-119. DOI: 10.1007/s10995-013-1240-y.
- 15) Osamor, P. E., & Grady, C. (2016). Women's autonomy in health care decision-making in developing countries: a synthesis of the literature. *International Journal of Women's Health*, 191-202. Doi: 10.2147/IJWH.S105483.
- 16) Rahman, M. M., Mostofa, M. G., & Hoque, M. A. (2014). Women's household decision-making autonomy and contraceptive behavior among Bangladeshi women. *Sexual & Reproductive Healthcare*, 5(1), 9-15. Doi: 10.1016/j.srh.2013.12.003.
- 17) Rizkianti, A., Afifah, T., Saptarini, I., & Rakhmadi, M. F. (2020). Women's decision-making autonomy in the household and the use of maternal health services: an Indonesian case study. *Midwifery*, 90, 102816. Doi: 10.1016/j.midw.2020.102816
- 18) Saaka, M. (2020). Women's decision-making autonomy and its relationship with child feeding practices and postnatal growth. *Journal of Nutritional Science*, 9, e38. Doi: 10.1017/jns.2020.30.
- 19) Sado, L., Spaho, A., & Hotchkiss, D. R. (2014). The influence of women's empowerment on maternal health care utilization: evidence from Albania. *Social Science & Medicine*, 114, 169-177. Doi: 10.1016/j.socscimed.2014.05.047.
- 20) Salvador, C. J., Ebrahim, N. B. (2024). Women's Decision-Making Autonomy and Use of Maternal Healthcare Services among Filipino Women. *Universal Journal of Public Health*, 12, 508 -514. DOI: 10.13189/ujph.2024.120308.
- 21) Sougou, N. M., Bassoum, O., Faye, A., & Leye, M. M. M. (2020). Women's autonomy in health decisionmaking and its effect on access to family planning services in Senegal in 2017: a propensity score analysis. *BMC Public Health*, 20, 1-9. <https://doi.org/10.1186/s12889-020-09003-x>.
- 22) Tesfa, D., Azanaw, M. M., Gebremariam, A. D., Engidaw, M. T., Tiruneh, M., Zemene, M. A., ... & Dessie, A. M. (2022). Women's independent decision-making power and determinants on not to use contraceptives among currently married women in Ethiopia using demographic and Health Survey data: Multilevel Analysis. *BMC Women's Health*, 22(1), 541. <https://doi.org/10.1186/s12905-022-02051-y>.
- 23) United Nations Population Fund (n. d.) Maternal mortality [Internet]. United Nations Population Fund. [cited 2024 Aug 30]. Available from: <https://ethiopia.unfpa.org/en/topics/maternal-health-17>.
- 24) USAID Policy. Equality and Women's Empowerment Policy (2012). USAID; [cited 2024 Sept 21]. Available from: <https://www.usaid.gov/sites/default/files/2022-05/GenderEqualityPolicy.pdf>.
- 25) UNICEF (2024). Prenatal Care. UNICEF, 2024 Jan; [cited 2024 Sept 20]. Available from: <https://data.unicef.org/topic/maternal-health/prenatal-care/>.
- 26) UNICEF (2022). United Nations Children's Fund, delivering for women: Improving maternal health services to save lives. UNICEF New York: UNICEF, 2022; [cited 2024 Sept 9]. Available from: file:///C:/Users/user/Downloads/Delivering-for-women_brochure_8-May-2022.pdf.
- 27) UN WOMEN (n. d.). Facts and figures: Economic empowerment. UN Women; [cited 2024 Sept 5]. Available from: <https://www.unwomen.org/en/what-we-do/economic-empowerment/facts-and-figures>.
- 28) WHOa. The Global Health Observatory: Explore a world of health [Internet]. WHO. [cited 2024 Sept 20]. Available from: <https://www.who.int/data/gho/indicator-metadata-registry/imr-details/4622>.
- 29) WHOb (n. d.). The Global Health Observatory. Explore a world of health data [Internet]. [Cited 2024 Sept 19]. Available from: <https://www.who.int/data/gho/indicator-metadata-registry/imr-details/80>
- 30) WHO (2024). Maternal Mortality. WHO; 2024 Apr; [cited 2024 Sept 14]. Available from: <https://www.who.int/news-room/fact-sheets/detail/maternal-mortality>.



There is an Open Access article, distributed under the term of the Creative Commons Attribution – Non Commercial 4.0 International (CC BY-NC 4.0) (<https://creativecommons.org/licenses/by-nc/4.0/>), which permits remixing, adapting and building upon the work for non-commercial use, provided the original work is properly cited.

The Argument Structure of Intransitive Verbs in Toba Batak Language Aek Kanopan Dialect: A Grammatical Typology Analysis



Asridayani¹, I Ketut Artawa², I Nyoman Udayana³, Ketut Widya Purnawati⁴

^{1,2,3,4} Fakultas Ilmu Budaya Program Doktor Ilmu Linguistik Universitas Udayana, Denpasar-Bali

ABSTRACT: The aim of the research is to describe the argument structure of intransitive verbs in Toba Batak language (TBL) Aek Kanopan dialect based on grammatical typology analysis. Data collections are gathered by applying conversational and listening method. Meanwhile, the main technique in collecting the data is elicitation technique, which is continued by several techniques, i.e. recording technique and taking note. The data is analyzed by distributional method as suggested by Sudaryanto (2015) and Mahsun (2011). With the use of the oral and written data, as well as the observation method, the analyzing data is done by using substitutional method, translational method, and referential method. The results of the analysis are provided by formal and informal methods. The result of this research shows that the argument structure of intransitive verbs in Toba Batak Language, Aek Kanopan dialect is that intransitive verbs can be divided into two types, namely verbs involving experiencer verbs and action verbs. Both types of verbs require only one argument, the subject, which grammatically functions as the only argument in the sentence. Semantically, the subject can act as an agent who performs an action or as an experiencer who experiences a state or feeling. Then, typologically of grammatical, the argument structure of intransitive verb in TBL Aek Kanopan dialect involved as an accusative-type language.

KEYWORDS: Argument Structure, Verb predicates, Intransitive verbs, Toba Batak Language, Aek Kanopan

I. INTRODUCTION

1.1 Background

Toba Batak language (hereinafter abbreviated as TBL) is a regional language used by Toba Batak tribe, especially those living in North Tapanuli Regency, North Sumatra Province. TBL is still used by Batak people as their communication language. This language is also used by Batak Toba people in other regions across the country (Sibarani, 2003:2). The term "Batak Toba" originates from Toba Batak language, and it is used to refer to any community of speakers of a language that is very similar to the one used in Toba. However, it cannot be denied that this language often faces difficulties in communication, especially when used by Naposobulung or young people.

TBL belongs to the Austronesian language family and is part of the Batak language group. (Napitupulu, 2021:9). The Batak tribe is located in North Sumatera, with a population of 8,466,969 people. (Badan Pusat Statistik 2020). The speakers of TBL inhabit the western and southern regions of Lake Toba. This language historically used the Batak script, but currently, its speakers generally use the Latin script. One of the TBL researchers, in his activities, wrote in his book which was translated into English by Miss Jeune Scott with the title *A Grammar of Toba Batak* (Van der Tuuk, 1971). Van der Tuuk focused on the sound system and parts of speech or on the fields of phonology and morphology. The study of word classes is not the study of the order of words in a sentence, but rather the study of the order within words and word formation.

According to Nababan (1981), in his book *A Grammar of Toba Batak*, Toba Batak is a dialect of the Batak language. The four dialects commonly referred to as Batak are Toba, Angkola (Mandailing), Simalungun, and Karo (Karo+Pak-Pak). Furthermore, Sibarani (1997) states that the Batak ethnic group consists of five sub-ethnic groups: Batak Toba; Batak Karo; Batak Simalungun; Batak Pak Pak-Dairi; and Batak Angkola-Mandailing. Many Batak people from the five sub-tribes have left their region and migrated. In Aek Kanopan, the Toba Batak tribe, who live in other regions, speak Toba Batak dialect.

The Argument Structure of Intransitive Verbs in Toba Batak Language Aek Kanopan Dialect: A Grammatical Typology Analysis

TBL Aek Kanopan dialect serves as the language used in that speech community, for example, in everyday conversations, in customary practices, and as a medium in sacred religious ceremonies/worship events. The Batak Toba ethnic community scattered across North Tapanuli Regency uses TBL as a symbol of regional pride. Additionally, TBL serves as a symbol of regional identity and as a means of expressing thoughts and feelings. This underlies that TBL is used in the social interactions of that community. TBL is a language that has its own unique characteristics and distinctions that set it apart from other Batak languages. The uniqueness is evident in the phonetic level, word forms, and sentence structures of TBL Aek Kanopan Dialect, which has its own system, such as the verb structure in TBL, which is usually VOS but can also be SVO like Indonesian because the verb position in TBL Aek Kanopan Dialect can occupy a position in the middle of the sentence after the subject position and at the beginning of the sentence as previously explained. Pay attention to the following example that shows an intransitive verb:

(1-1)	a	<i>Anggina</i>	<i>mar-lojong</i>	<i>tu</i>	<i>jabu</i>
		Adik=POS3	VA-lari	PREP	rumah
		'His younger sibling ran to the house'			
(1-1)	b	<i>Mar-lojong</i>	<i>angina</i>	<i>tu</i>	<i>jabu</i>
		VA-lari	Adik=POS3	PREP	rumah
		'His younger sibling ran to the house'			

In clauses (1-1a and 1-1b) above, the verb *mar-lojong* 'to run' is classified as an intransitive verb that only requires the presence of one argument in the clause. The verb *mar-lojong* 'to run' in clauses (1-1a and 1-1b) is an intransitive verb with the active marker *mar-* as a morphological marker of the intransitive verb. Clauses (1-1a and 1-1b) show the verb *mar-lojong* 'to run,' which means 'to run' is an intransitive verb that syntactically does not require the presence of an argument functioning as an object, but semantically, the verb represents an action that implies an activity of running performed by the subject, which in this case is '*anggi na*,' meaning 'her younger sibling.' Therefore, the verbs mentioned above are intransitive verbs that semantically belong to action verbs which, in syntactic studies, do not require the presence of an argument functioning as an object. However, *tu jabu* 'to the house' is not an argument because its presence is optional (adjunct) and it has the preposition marker *-tu*.

Dixon (2010:115) states that transitivity is a multi-layered phenomenon, and like other aspects of grammar, transitivity has a semantic basis. Transitivity describes the semantic basis of how to recognize core argument functions and how semantic roles are mapped to the same syntactic functions. Dixon (2010) also explains further that each clause has a transitivity value that determines the desired number of core arguments. There are several common conventions for marking the core argument so that the audience recognizes it. Next, verbs are divided into groups of degrees of transitivity, depending on the type of clause that appears.

All languages have transitive or intransitive sentences, which means that TBL also has them. This research analyzes the transitivity argument structure of TBL bound by its verb predicate. In addition, affixes that mark verbal transitive constructions are discussed when analyzing verb constructions. As stated by O'Grady et al. (1989:141), the subcategorization frame $-\llbracket _ \text{NP} \rrbracket$ - indicates that verbs cannot appear together with sibling NPs. Verbs of this type are usually referred to as intransitive. On the other hand, transitive verbs require a direct object, as indicated by the frame $+\llbracket _ \text{NP} \rrbracket$. But, in this research, the researcher focuses on the argument structure of intransitive verbs.

The uniqueness and distinctiveness of the TBL system is an important reason for this research because until now, studies on TBL Aek Kanopan dialect, especially research on The Argument Structure of Intransitive verbs in TBL Aek Kanopan dialect: A grammatical typology analysis have not existed. In addition, this research needs to be done because TBL Aek Kanopan dialect is one of the sources for the Indonesian language among the regional languages in Indonesia. Therefore, this language needs to receive attention from language experts and researchers, compared to several other language studies, research conducted on TBL Aek Kanopan dialect can be said to be still lacking or relatively few.

Some studies and writings that have been conducted and related to TBL Aek Kanopan dialect are research conducted by Basaria (2014) on '*Argument Structure of Transitive Sentence in Toba Batak Language*'. This study shows that in TBL the indirect object argument structure is placed before the verb and the direct object argument structure being the subject itself, followed by the indirect object. In bi-transitive sentences, there is one oblique argument characterised by the preposition /*tu-*/. Manurung & Mulyadi (2021) entitled *The Semantic Role of Core Argument on Batak Toba Language*. The results show that the semantic roles of core arguments in TBL consist of macro roles and thematic roles. The macro role consists of actor and agent, while the thematic

The Argument Structure of Intransitive Verbs in Toba Batak Language Aek Kanopan Dialect: A Grammatical Typology Analysis

role consists of agent, experiencer, effector, addressee, theme, source, and patient. The last research is Lestari & Mulyadi (2023) on *Kategori dan Peran Tematis Argumen Klausa Verbal pada Bahasa Batak Toba*. The results show that TBL verbal clause categories consist of two parts: verbal and non-verbal clauses. A verbal clause consists of three components: transitive clauses, which consist of active clauses, passive clauses, and reciprocal clauses; intransitive clauses, and semitransitive clauses. Although all of these studies are encouraging, they only provide an initial description of TBL in general and have not examined the argument structure of intransitive verbs in TBL Aek Kanopan dialect based on grammatical typology analysis. Therefore, this argument structure study needs to be clarified further based on the thoughts of syntax experts.

Considering the aforementioned linguistic phenomenon, it is deemed important to conduct research to preserve the language, or at least to document it before it is feared to become extinct. Therefore, as one of the regional language studies in the archipelago that belongs to the Austronesian language group, the researcher wants to conduct a study on the argument structure of intransitive verbs in TBL Aek Kanopan dialect related to grammatical typology. According to Jufrizal (2007), this research is very important and scientifically valuable because there are still many differing opinions on how regional languages in Indonesia are typologically classified. Even to gain a better understanding of the syntactic typology of the Indonesian language, further research is needed.

1.2 Research Method

In this study, researchers used qualitative research methods by focusing on the argument structure of Toba Batak language Aek Kanopan dialect: a grammatical typology analysis produced by native speakers of Toba Batak language from Aek Kanopan. According to Mahsun (2005:257), qualitative research is an activity that is carried out simultaneously with data analysis activities. As for the definition of qualitative research methods according to Sudaryanto (2015:3), qualitative descriptive research is when activities attempt to describe or describe in words or language about information obtained from a research setting. In other words, qualitative descriptive research aims to describe, explain, and answer in detail the problems being studied by studying a phenomenon carefully.

In collecting data in this study, researchers use interview techniques and recording techniques. This interview technique is used to obtain data about argument structure found in intransitive verbs both experiential and action verb. After the data was found from data collection in the form of interviews with Toba Batak informants, the researchers recorded the conversations between speakers and researchers. Furthermore, with the use of the oral and written data, as well as the observation method, the analyzing data is done by using distributional method, translational method, and referential method. The results of the analysis are provided by formal and informal methods.

II. THEORETICAL REVIEW

2.1 Verb Predicate

Dixon (2011:9) states that in terms of semantic roles and syntactic relations, verbs, which are the center of a clause, can refer to activities so that there are a number of participants involved in the activity and each activity has a role. Besides referring to an action, verbs can also refer to a state so that there are participants who experience the state in question. Hence, a verb predicate is a predicate that expresses an action, event or state of flux. Verb predicates are usually formed by verbs (Dixon, 2010).

Verbs convey the meaning of action, process, or action in a semantic way. Verbs are separated into two categories based on their form: derived verbs and basic free verbs. Verbs can be classified as either transitive or intransitive based on the number of arguments they contain. Verbs can be classified as either active or passive depending on how they relate to the argument. In grammar, a verb is considered 'intransitive' if it takes only one core argument, 'monotransitive' if it takes two arguments; and 'bitransitive' if it takes three arguments. Verbs can be classified based on the category of ditransitivity in a clause. Transmissibility is a syntactic category that has a semantic foundation (Dixon, 2010:90). The classification of verbs can be divided into: transitive verbs, intransitive verbs, and ambitransitive verbs (Dixon, 2010:124). The classification of verbs can be divided into: transitive verbs, intransitive verbs, and ambitransitive verbs (Dixon, 2010:124). In this research, the researcher focuses on intransitive verbs.

Intransitive Verbs

Dixon (2011:9) states that from the perspective of semantic roles and syntactic relations, verbs, which are the center of a clause, can refer to activities involving a number of participants, each of whom has a role in the activity. Verbs can also refer to a state or condition, so there are participants who experience the mentioned state. Therefore, a verbal predicate is a predicate that expresses an action, event, or changing state. Usually, verbs are used to express the action, existence, or event of the subject in a sentence. As the core of the sentence, a verbal predicate provides important information about what is done, experienced, or happening to the subject. Without a predicate, a sentence will feel empty and lack clear meaning.

The Argument Structure of Intransitive Verbs in Toba Batak Language Aek Kanopan Dialect: A Grammatical Typology Analysis

Intransitive verbs as verbs that do not require an object to complete their meaning (Alwi, 2003). Intransitive verbs can stand alone in a sentence that indicates an action, process, or state experienced by the subject and object. The proposition that uses that verb only has one argument. Essentially, intransitive verbs require one argument in the clause. This is in line with Dixon's opinion, which states that intransitive verbs are verbs that only require one core argument, referred to as S.

Intransitive verbs can be distinguished according to their semantic properties. There are verbs that contain the meaning of 'experience' or 'experiential verbs', and there are verbs that contain the meaning of 'action' or 'action verbs'. The term 'action' should not be misinterpreted: it does not refer to 'activity' which is characteristic of transitive verbs. In transitive verbs, something is produced (expressed by the object), and therefore the role of the subject is necessarily that of an 'actor'. Conversely, the subject of the (intransitive) verb known as 'performative verb' contains the role of 'performer', but without any 'transfer' of that 'action' to an 'object'. Because of the subject's role, this verb is called a 'performative verb'. The difference between experiential verbs and performative verbs is easy to understand. For example, the verbs sleep or fall are experiential verbs; there is no 'activity' required from the subject to sleep or fall. In some languages, there are verbs that are strictly categorized as intransitive verbs, such as in English the verbs sleep, cry, run, die, grow, and so on (Dixon, 2005).

2.2 Semantic Role

The semantic role of verbs is the role assigned to predicate arguments that are typically verbs. The semantic role theory used follows the idea of Valin Jr. and Lapolla (1999) who offer the labels actor and undergoer to explain the semantic relation between predicates and their arguments. Furthermore, semantic roles are generalisations about the role of participants in the event indicated by the verb (Booij, 2007:191). Semantic roles are useful in classifying verb arguments. According to Levin and Hovav (2005:3), a semantic role representation will reduce the meaning of a verb through a set of roles assigned to its arguments.

A semantic role is the role or function played by an argument (noun or noun phrase) in relation to the action or event expressed by the predicate. This role describes how each argument is involved in the situation expressed by the sentence, which relates to the meaning of the action or circumstance (see Dixon 2005, 2010).

Dixon (2005, 2010) provides a comprehensive classification of semantic roles based on verb structure and argumentation. His theory presents the view that verbs carry certain semantic roles, and the arguments associated with these verbs also play an important role in the formation of sentence structure. The following is the division of semantic roles based on argument structure according to Dixon's theory: *Agent, Patient, Recipient, Experiencer, Theme, Source, Goal, Location, Instruments, Cause, Stimulus, and Beneficiary*.

2.3 Argument Structure

The term argument is similar in meaning to the subject and/or object in a clause. In simple terms, Artawa (2002:8) says that argument structure is predicate information (usually related to verbs) and concerns the syntactic-semantic information of predicates. Furthermore, argument structure is also suggested by Valin Jr. and Lapolla (1999:28) who mention that the term argument actually refers to semantic arguments (arguments based on causes and semantic factors), while core argument is a notion that refers to the syntactic level. In this study, the structure of the argument is seen syntactically (grammatically) by paying attention to its relationship as a form of semantic matter. Alsina (1996:4-7) mentions that a predicate expresses the relationship between the actors in a clause. In simple terms, the meaning of the term argument is equivalent to the meaning of the clause and/or its subject. The number of arguments in a clause or sentence is determined by the verb as the core (head) of the clause or sentence, because arguments are syntactic and semantic elements required by the verb and are usually related to participation in an event or state expressed by the verb or its predicate (Williams, 1991) in Budiarta. (2013:37). This study examines the structure of arguments syntactically (grammatically) by considering how they relate as a form of semantics.

Argument structure, as defined before, refers to the systematic organization of arguments (participants) in a clause according to their syntactic and semantic roles. This framework explores how participants such as subjects, objects, and other core arguments are encoded in language, focusing on the relationships between these roles and the grammatical structures that express them. It encompasses both the syntactic positions these roles occupy in sentences and the semantic roles they play in relation to the predicate, providing insights into how languages universally and variably encode these fundamental aspects of sentence structure.

2.4 Linguistics Typology

Language typology is generally intended to classify languages through structural behaviour based on the peculiarities of the language. Basically, language typology studies can be carried out on any language structure, taking into account the most dominant features of the language (Comrie, 1989: 33-38).

The Argument Structure of Intransitive Verbs in Toba Batak Language Aek Kanopan Dialect: A Grammatical Typology Analysis

This research is based on grammatical typology theory. The term grammatical typology is often used to differentiate it from the term functional typology, a linguistic typology study that emphasizes the study of the functional aspects of language; language as a tool of communication. (Jufrizal, 2012:3-4). Both grammatical typology and functional typology originate from linguistic typology as the parent term and the basis of its study. However, the term grammatical typology can already be directly referred to the concept of linguistic typology. (see Givon, 1984, 1990; Jufrizal, 2004, 2007; Artawa, 2005). The term grammatical in linguistics, specifically, often refers to the levels of morphology and syntax (morphosyntax), although linguists essentially refer to grammar as the levels of phonology, morphology, syntax, and semantics.

S (subject), A (agent), and P (patient) are the three syntactic arguments used in syntactic typology studies to determine language types. To discover language typology, the relationship between these components will direct the theoretical framework. The grammatical alliance system is related to language typology, especially in the context of syntax. According to Dixon (1994), systems or tendencies of grammatical alliances within or between clauses in a language are typologically known as basic grammatical alliances. This alliance can be the system of S=A, P, S = P, Sa = A, Sp = P, or other systems. According to Artawa (1998:127), the three systems of grammatical alliance-accusative, ergative, and S-division-are the focal points for determining the grammatical typology that can be discussed for every language in the world.

In typological studies, there are two basic assumptions about sentences, namely: first, that the concept of predicate structure can be applied to all languages, and second, that both arguments: (i) differ in terms of their semantic relationship with the predicate and (ii) differ from each other through grammatical markers. Clause structure that has two arguments, one identified as the agent (actor) and the other as the patient. The agent and patient marked by grammatical features in a language are called grammatical roles. The concept of grammatical relations includes subjects, objects, and so on. Agent and patient are the two most important grammatical roles in typological studies. Three other grammatical roles that follow agent and patient are beneficiary, instrumental, and locative (Comrie, 1989).

III. RESULT AND DISCUSSION

Intransitive verbs have one argument that is also the grammatical subject and semantically functions as an agent or undergoer (patient, theme, benefactor, etc). In Toba Batak language Aek Kanopan dialect, intransitive verbs can be divided into two categories, namely experiencer intransitive verbs and action intransitive verbs. Here are explanations of argument structures for both types of verbs:

3.1 Argument Structure of Experiencer Intransitive Verbs of TBL Aek Kanopan Dialect.

Van Valin, Jr and LaPolla (1999:148-150) say that the verb with one core argument in syntax is known as intransitive verb. The argument structure of intransitive verbs also requires one FN argument element that can function as a grammatical subject and semantically as an agent or patient. An experiencer verb is a verb that shows a feeling, condition, or experience experienced by the argument, usually the subject is the recipient of the experience (experiencer). There is usually only one argument in an experiencer verb, which is the subject. According to Dixon (1994) theory, intransitive verbs are a type of verb that requires only one argument, usually functions as the subject in a clause, and does not require a direct object. One of the subclasses of intransitive verbs is experiencer verbs, which relate to mental and emotional experiences or states. In Toba Batak language of Aek Kanopan dialect, these experiencer verbs are often used to express a person's internal state. Experiencer verbs involve one argument that acts as an 'experiencer' or an individual who experiences or feels a state, feeling, or mental state. In this case, these verbs include *laugh, cry, faint, shiver, and fell*, then the subject is the person experiencing the state. The following examples illustrate the TBL predication built by an intransitive verbal predicate:

(2-1) a *Marasa sodih do ibana*
VA-rasa sedih PAR 3SG
'She/he felt sad.'

(2-1) b *Mar-tangis halahi di sikkola*
VA-tangis 3PL PREP sekolah
'They cried at school.'

The data (2-1a) is constructed by the verbal predicate *marasa* 'fell' and has one argument *ibana* "she/he" and a non-argument element *sodih* 'sad'. The intransitive verbal predicate *marasa* 'fell' requires only one argument *ibana* 'she/he' which grammatically functions as subject and as a experiencer in semantic role because *ibana* 'she/he' felt sad and can be supplemented with other non-arguments *sodih* 'sad' which categorized as complement to intransitive verb *marasa* 'fell'. The data (2-1b) is also

The Argument Structure of Intransitive Verbs in Toba Batak Language Aek Kanopan Dialect: A Grammatical Typology Analysis

constructed by the intransitive verb *mar-tangis* 'cry' and has one argument *halahi* 'they' and a non-argument element *di sikkola* 'at school'. The argument 'di sikkola' functions as both subject and patient as it is affected by the verb semantics of the clause. The intransitive verbal predicate *mar-tangis* 'cry' requires only one argument *halahi* 'they' which grammatically functions as a subject and semantically functions as an experience and can be supplemented with other non-arguments

3.2 Argument Structure of Action Intransitive Verbs of TBL Aek Kanopan Dialect

Dixon (1994) states that agentive/action intransitive verbs are a type of verb that describes an action performed by an agent without involving a direct object. These verbs require only one argument, which is the subject in the role of the agent, who performs an action actively. Action verbs are verbs that show the action performed by the subject. In this case, the subject acts as an agent (actor) who performs an activity. Action intransitive verbs always involve one argument that acts as an agent, i.e. the doer of an action. The subject is the one who actively performs the action stated by the verb. Like all intransitive verbs, action verbs do not require a direct object in the clause. It is the agent subject alone that carries out the action without affecting other objects.

- (3-1) a *Mangan do ibana di jabumi*
 VA-makan PAR 3SG PREP rumah=POS
 'She/he ate at your house.'
- (3-1) b *Mar-dalan Ucok tu jabu*
 VA-jalan Ucok PREP rumah
 'Ucok walks to home.'
- (3-1) c *Ma-dabu si Rogap*
 VA-jatuh si Rogap
 'Si Rogap fell down.'
- (3-1) d *Mar-lange si Butet*
 VA-renang si Butet
 'Si Butet swims.'
- (3-1) e *Laho do halahi tu Jakarta*
 VA-pergi PAR 3JM PREP Jakarta
 'They went to Jakarta.'

Clause (3-1a) is constructed by the verbal predicate which is included in an intransitive verb *mangan* 'eat' and has one argument *ibana* "she/he" and a non-argument element *tu jabumi* "to your house". The argument 'tu jabumi' functions as both subject and patient as it is affected by the verb semantics of the clause. The intransitive verbal predicate *mangan* 'eat' requires only one argument and can be supplemented with other non-arguments. Clause (3-1b) is also constructed by the verbal predicate *mar-dalan* 'walk' and has a single argument *Ucok* 'Ucok' which grammatically functions as the subject and semantically functions as the agent. Besides the argument 'Ucok', clause (3-1b) also has a non-argument element, namely *tu jabu* 'to home'. The same can also be seen in clauses (3-1c), (3-1d) and (3-1e). The clauses are also formed by the verbal predicate *madabu* 'fall' in clause (3-1c), verbal *marlange* 'swim' in clause (3-1d) and verbal *laho* 'go' in clause (3-1e). Each clause (3-1c), (3-1d) and (3-1e) has the same argument that functions as the grammatical subject and semantically functions as the agent, namely 'si Rogap' in clause (3-1c), 'si Butet' in clause (3-1d), and *halahi* 'they' in clause (3-1d). Besides the argument element, there is also a non-argument element that builds clause (3-1e), namely *tu Jakarta* 'to Jakarta' which functions as an adverbial.

3.3 The Tendencies of Grammatical Typology in TBL Aek Kanopan Dialect

In accusative grammatical systems, the subject of an intransitive verb (S) is treated the same as the subject of a transitive verb (A), while the object of a transitive verb (O) is treated differently. In other words, both the subject that experiences the action (experiencer) and the subject that performs the action (actor) on intransitive verbs have the same grammatical marking as the subject or transitive verbs. Based on this pattern, argument structure of intransitive verb in Toba Batak language Aek Kanopan dialect tends to follow the accusative pattern. In intransitive verbs, both subjects acting as action and experiencers get the same

The Argument Structure of Intransitive Verbs in Toba Batak Language Aek Kanopan Dialect: A Grammatical Typology Analysis

marking as subjects in transitive verbs. Intransitive verbs do not mark differently whether the subject is an actor or an experiencer, but rather use the same subject structure as in transitive verbs.

Syntactically, TBL Aek Kanopan dialect is a nominative-accusative language (called accusative language for short) because it treats S as equal to A, and different from P ($S = A, \neq P$). The typological test to arrive at this conclusion is done by looking at the syntactic (verbal) construction of TBL Aek Kanopan dialect, namely the resultative construction or in other words, the passive construction. Diathesis studies show that TBL Aek Kanopan dialect basic clauses have active diathesis and their derivative constructions have passive diathesis. In typological studies, the existence of predicators and arguments is marked in grammatical features, both agent (doer) and patient (sufferer) markers. The existence of these markers is an important study in language typology (see Comrie, 1989).

Comrie (1989) also says that structurally the basic verb object becomes the subject in passive or anticausative constructions. It can also be said that the agent of passive sentences is arbitrary, while the agent in anticausative is never expressed. Artawa (1998) says that the term resultative construction can be aligned with the term anticausative. According to Artawa (1998) resultative constructions are also known as constructions similar to passive constructions. Therefore, in this research, the study of resultative constructions is also related to passive constructions found in TBL. The resultative constructions of TBL Aek Kanopan dialect or passive constructions TBL Aek Kanopan dialect are characterised by the prefix *di-* 'di' and the prefix *tar-* 'ter'. The prefix *di-* can be used both when the agent of the action is not mentioned and when the agent is mentioned except when the agent is the first singular and the first plural. The prefix *di-* cannot be used when the agent is the first singular and the first plural.

Different from the prefix *di-* 'di', the resultative construction (passivising) with the prefix *tar-* 'ter' in TBL Aek Kanopan dialect realises a resultative construction that has the meaning of 'accidentally' or 'unintentionally'. Consider the following data of intransitive verbs that show resultative constructions using the prefix *tar-* 'ter':

- (3-2) a *Panangko i tar- takkap ni massa*
 pencuri ART RES-tangkap PREP massa
 'The thief was caught (by) the masses'
- (3-2) b *Jabu i tar- tutung (api)*
 rumah ART RES-bakar (api)
 'The house was burnt down (by fire)'

In data (3-2a), passivisation or resultative construction with the prefix *tar-* 'ter' can occur on intransitive verbs that require a 'general' or 'natural' agent, meaning that the agent in the data is an animate being, namely *panakko i* 'the thief' has a will, the actor, namely *massa* 'the masses' and the preposition *ni* 'by' as a passive marker in TBL Aek Kanopan dialect sentences. The presence of the preposition *ni* 'by' is arbitrary because the passive marker may or may not be present. In other words, the presence of the passive marker *ni* in TBL Aek Kanopan dialect can be omitted. However, data (3-2b) are resultative constructions that use passivisation in the form of the prefix *tar-* 'ter' whose agents are non-living beings, namely *jabu i* 'the house' (3-2b) so the presence of the preposition 'by' tends not to be important. This is because resultative constructions in passives that use the accidental prefix *tar-* 'ter' and whose agents are inanimate beings cause them to be weak passives.

Thus, TBL Aek Kanopan dialect intransitive verbs can be derived from pre-verbal based by providing resultative construction markers, namely the prefix *di-* and the passive-meaning prefix *tar-*. The treatment of TBL Aek Kanopan dialect as an accusative language has, so far, been the basis for researching, describing, and writing the grammar of TBL.

In the argument structure data on intransitive verbs of Toba Batak language Aek Kanopan dialect described earlier that intransitive verbs denoting experiencer verbs and action verbs semantically, the subjects 'he/she' and 'they' in data (2-1a, b) and also 'the thief' and 'the house' in data (3-1a, b) are treated in the same way without any change in form, whether they are Agent as actions or as experiencers. This shows an accusative tendency where S (intransitive subject) is treated like A (transitive subject).

Based on the grammatical typology analysis, the argument structure of intransitive verb in Toba Batak language Aek Kanopan dialect tends to follow the accusative pattern. In this pattern, subjects on intransitive verbs (both as actions and experiencers) are treated in the same way as subjects on transitive verbs, without any difference in marking. This shows that the Aek Kanopan dialect of Toba Batak language is not active-stative in the marking of argument structures on intransitive verbs, as there is no distinction between subjects who act actively and subjects who experience a feeling or condition.

IV. CONCLUSIONS

Based on the explanation of the previous analysis, the grammatical typology analysis of the argument structure of intransitive verbs in Toba Batak language Aek Kanopan dialect is that intransitive verbs can be divided into two types, namely verbs involving

The Argument Structure of Intransitive Verbs in Toba Batak Language Aek Kanopan Dialect: A Grammatical Typology Analysis

agentive verbs and experiencer verbs. Both types of verbs require only one argument, the subject, which grammatically functions as the only argument in the sentence. Semantically, the subject can act as an agent who performs an action or as an experiencer who experiences a state or feeling. In experiencer verbs, the argument is usually just the subject experiencing the feeling or experience. In action verbs, the subject acts as the agent who performs the action or activity. Action intransitive verbs describe active actions performed by the subject without involving a direct object, making them an important part of the analysis of grammatical typology of language.

This argument structure tendency shows that Toba Batak language Aek Kanopan dialect is accusative in grammatical typology. This can be seen from the same treatment of subjects (S) in intransitive verbs and actors or Agent (A) in transitive verbs. Both subjects who act and experience are treated in the same way, both in terms of position in the sentence and grammatical marking. This indicates that Toba Batak language Aek Kanopan dialect does not distinguish grammatically between subjects who act actively and subjects who experience a feeling or state, thus leading to accusative typology.

REFERENCES

- 1) Alsina, Alex. (1996). *the Role of Argument Structure in Grammar: Evidence from Romance*. Stanford California: CSLI Publishers.
- 2) Alwi, H., Dardjowidjojo, S., Lapoliwa, H., Moelino, A. M. (2000). *TataBahasa Baku Bahasa Indonesia*. Jakarta: Balai Pustaka.
- 3) Alwi, Hasan, dkk. (2003). *Tata Bahasa Baku Bahasa Indonesia (edisi ketiga)*. Jakarta: Balai Pustaka
- 4) Alwi, Hasan, dkk. (2017). *TataBahasa Baku Bahasa Indonesia. Edisi Keempat*. Jakarta: Badan Pengembangan dan Pembinaan Bahasa.
- 5) Artawa, I Ketut. (1994). *Ergativity and Balinese Syntax*. Disertasi. Melbourne: La Trobe University.
- 6) Artawa, I Ketut. (2000). *Alternasi Diatesis pada Beberapa Bahasa Nusantara*. Dalam *Kajian Serba Linguistik untuk Anton Moelino Periksa Bahasa* (ed. Bambang Kaswanti Purwo). Jakarta: Universitas Katolik Indonesia Atma Jaya dan PT. BPK Gunung Mulia.
- 7) Artawa, I Ketut. (2004). *Balinese Language: A Typological Description*. Denpasar: CV. Bali Media Adhikarsa.
- 8) Artawa, I Ketut. (2005). "Tipologi Bahasa dan Komunikasi Lintas Budaya" (Orasi Ilmiah Pengukuhan Guru Besar bidang Linguistik). Denpasar: Universitas Udayana.
- 9) Artawa, Ketut. & Jufrizal. (2021). *Tipologi Linguistik: Konsep dan Aplikasinya*. (Edisi Revisi). Denpasar: Pustaka Larasan.
- 10) Badan Pusat Statistik Kabupaten Labuhanbatu Utara. 2023. <https://labuhanbatuutarakab.bps.go.id/>
- 11) Badan Pusat Statistik Sumatra Utara. 2020. Persebaran bahasa daerah (online). Diakses dari: <https://sumut.bps.go.id/>. Tanggal 23 September 2021
- 12) Baker, C. (2011). *Foundation of bilingual education and bilingualism 5th edition*. Bristol: Multilingual Matters.
- 13) Basaria, Ida. (2014). Argument Structure of Transitive Sentence in Toba Batak Language. *Febrika Dwi Lestari & Mulyadi Diglosia: Jurnal Kajian Bahasa, Sastra, dan Pengajarannya* Volume 6 Nomor 2 (2023) 342 *IOSR Journal of Humanities and Social Science*, 19(9), 7–14. <https://doi.org/10.9790/0837-19990714>
- 14) Budiarta, I Wayan. (2013). "Tipologi Sintaksis Bahasa Kemak" (Disertasi). Denpasar: Universitas Udayana.
- 15) Butar-Butar, Junita, R. (2008). "Peran Semantis Verba Bahasa Batak Toba." Medan: Universitas Sumatera Utara.
- 16) Catford, J.C. (1965). *A Linguistik Theory Of Translation*. Walton Street : Oxford University Press
- 17) Comrie, Bernard. (1981, 1989). *Linguistics Universals and Linguistics Typology*. Oxford: Basil Blackwell Publisher Limited
- 18) Comrie, Bernard. (1989). *Linguistics Typology*. Dalam F.J. Newmwyer (ed.). *Linguistics: The Cambridge Survey*. Vol I, hlm.: 447-467. Cambridge: Cambridge University Press.
- 19) Croft, William. (1993). *Typology and Universals*. Cambridge: Cambridge University Press.
- 20) Dixon, R.M.W. (1994). *Ergativity*. Cambridge: Cambridge University Press.
- 21) Dixon, R.M.W. (2005, 2011). *A Semantic Approach of English Grammar. Second Edition*. United States: Oxford University Press.
- 22) Dixon, R.M.W. (2010). *Basic Linguistics Theory*. Volume 2 Grammatical Topics. Oxford: University Press
- 23) Dixon, R.M.W. (2012). *Basic Linguistics Theory*. Volume 3 Further Grammatical Topics. Oxford: University Press.
- 24) Djajasudarma, T. F. (1993). *Metode Linguistik: Ancangan Metode Penelitian dan Kajian*. Bandung: Eresco.
- 25) Givon, Talmy. (1984). *Syntax: A Funtional-Typological Introduction. Vol I* Amsterdam: John Benjamins Publishing Company.
- 26) Goddard, C. (1998). "Semantic Analysis". *The Sematic of Emotion*, 86-110.

The Argument Structure of Intransitive Verbs in Toba Batak Language Aek Kanopan Dialect: A Grammatical Typology Analysis

- 27) Hopper, P. J., Thompson, S. A. (editor). (1982). *Syntax and Semantics: Studies in Transitivity* (Volume 15). New York: Academic Press, Inc.
- 28) Jufrizal. (2004). "Struktur Argumen dan Aliansi Gramatikal Bahasa Minangkabau" (Disertasi). Denpasar: Universitas Udayana.
- 29) Jufrizal. (2007). *Tipologi Gramatikal Bahasa Minangkabau: Tataran Morfosintaksis*. Padang: Universitas Negeri Padang Press.
- 30) Jufrizal. (2012). *Tatabahasa Bahasa Minangkabau: Deskripsi dan Telaah Tipologi Linguistik*. Padang: Universitas Negeri Padang Press.
- 31) Lestari, Febrika Dwi., & Mulyadi. (2023). Kategori dan Peran Tematis Argumen Klausa Verbal pada Bahasa Batak Toba. *Diglosia: Jurnal Kajian Bahasa, Sastra, dan Pengajarannya*. 6(2), 315-332.
- 32) Kozok, Uli. (2009). *Surat Batak: Sejarah Perkembangan Tulisan Batak*. KPG (Kepus-takaan Populer Gramedia).
- 33) Kozok, Uli. (2009). *Peran Zending dalam Perang Toba*. Medan: Pusat Studi Sejarah dan Ilmu-ilmu sosial.
- 34) Manurung, Y. H., & Mulyadi. (2021). The Semantic Role of Core Argument on Batak Toba Language. *International Journal of Research Publications*, 79(1), 155–160. <https://doi.org/10.47119/IJRP100791620212031>
- 35) Sudaryanto. (1990). *Aneka Konsep Kedataan Lingual dalam Linguistik*. Yogyakarta: Duta Wacana University Press.
- 36) Sudaryanto. (2015). *Metode dan Aneka teknik Analisis Bahasa*. Yogyakarta: Duta Wacana University Press.
- 37) W. O'Grady, M. Dobrovolsky, and M. Aronoff. (1989). *Contemporary Linguistics: An Introduction*. New York: St. Martin's Press



There is an Open Access article, distributed under the term of the Creative Commons Attribution – Non Commercial 4.0 International (CC BY-NC 4.0)

(<https://creativecommons.org/licenses/by-nc/4.0/>), which permits remixing, adapting and building upon the work for non-commercial use, provided the original work is properly cited.

Diversity of Medicinal Plants in Nubamado Village, Lembata District to Cure Livestock Diseases



Anyela Merici Beto Odjan¹, Agung Wijaya Subiantoro²

^{1,2}Department of biology education, Universitas Negeri Yogyakarta Indonesia

ABSTRACT: People in Indonesia who still use plants to cure livestock diseases are the people of Nubamado village. Knowledge about traditional medicines is very little known and is usually only passed on from generation to generation. The purpose of the study was to describe the types of plants or record the types of local medicinal herbs used by the community in curing animal diseases. The method used in this research is descriptive survey method, namely direct observation method and Participatory Rural Appraisal method, which is an assessment process oriented towards the involvement and active role of the community in research. The sampling technique on medicinal plants was carried out by means of researchers directly documenting it, while the informant technique was carried out by means of, Determination of the initial sample was carried out using Purposive Sampling. After the initial observation, the next informant selection was carried out using the Snowball Sampling method, which is an informant selection technique based on key informant recommendations. Based on the results of the study, there are 25 types of plants that are used by the people of Nubamado village as medicine, the part of the plant that is most often used by the community is the leaves. Family Zingiberaceae, Poaceae, Arecaceae, is the most widely used family as medicinal plants in Nubamado village, the second largest family is Solanaceae, Piperaceae and Fabaceae. The least family is Malvaceae, Euphorbiaceae, Piperaceae, Mimosaceae, Meliaceae, Rubiaceae, Musaceae, Alliaceae, Rutaceae, Myrtaceae, Caricaceae.

KEYWORDS: Ethnobotany, Lembata, Diversity, Medicinal Plants, Livestock Diseases

I. INTRODUCTION

Indonesia is a mega biodiversity country because it has a wealth of biodiversity. It is recorded that Indonesia is the second country after Brazil with the most biodiversity (Pranita, 2019). Indonesia as a tropical country also has extensive forests. The forest area is 125,817,022.96 ha (Kementerian Lingkungan Hidup dan Kehutanan, 2023), so it is dubbed as the "lungs of the world". Indonesian forests are a resource of plant diversity that is beneficial to Indonesia, one of which is as a medicine (Jalianery & Evi, 2020).

People in Indonesia who still use plants to cure livestock diseases are the people of Nubamado village. The Nubamado community in Lembata sub-district is known as one of the ethnic groups in Indonesia that still has a wealth of traditional knowledge in the field of traditional (natural) medicine. Since a long time ago, the people of Nubamado village have utilized plants as medicinal materials for livestock, the use of medicinal plants for livestock is an alternative treatment for the people of Nubamado village, especially farmers, because of the limited availability of synthetic drugs and the inability of the community to buy drugs due to high selling prices. The people of Nubamado village highly value traditional medicine over chemical medicine, as can be seen from the enthusiasm of the community in cultivating medicinal plants in the yard. The efficacy of medicinal plants has been proven by continuous use by the community so that it has become a culture for personal planting of plants until now (Utami Revina Dwi & Zuhud, 2019).

Knowledge about traditional medicines is very little known and is usually only passed on from generation to generation, and is difficult to convey freely. (Qasrin et al., 2020) said that village healers who have knowledge of traditional medicine are generally 50 years old so it is feared that there is no next generation who understands traditional medicine and as a result the continuity of the use of traditional medicine that has been used will be forgotten. This is in line with research conducted by Purwati et al (2007), who said that the increasing development of science, technology and economy in the country has resulted in the current younger generation being less interested in learning traditional medicine knowledge by utilizing plants.

Diversity of Medicinal Plants in Nubamado Village, Lembata District to Cure Livestock Diseases

Ethnobotany is a science related to the use of plants by communities for generations and over a long period of time. The contribution and role of ethnobotany is very broad and diverse both in the current generation and future generations including plant conservation and assessment of plant conservation status, ensuring the sustainability of food supplies, local to global food security, strengthening ethnic identity and nationalism, recognizing the rights of local communities to resource wealth and access to it, playing a role in the discovery of new medicines and others (Aziz et al., 2018). The purpose of the research is to describe the types of plants or record the types of local medicinal herbs used by the community in curing diseases in animals.

II. MATERIALS AND METHODS

A. Materials

The research was conducted in Nubamado Village, Nubatukan District, Lembata Regency. The tools and materials used in this research are plant exploration equipment and interview equipment. Plant exploration equipment in the form of GPS, and cameras while interview equipment in the form of interview guides. The object of research to be used in this study is the species of medicinal plants used by the people of Nubamado Village.

B. Methods

The method used in this research is a descriptive survey method, namely the direct observation method (Ajeng et al., 2019) and the Participatory Rural Appraisal method, which is an assessment process oriented towards the involvement and active role of the community in research (Jamun et al., 2020).

The sampling techniques used are sampling techniques on medicinal plants and sampling techniques on informants. Sampling techniques on medicinal plants are carried out by means of researchers directly documenting them after or while conducting interviews with informants. As for plants found in the garden and in the forest, researchers will document them directly in the garden or in the forest with the help of local residents or informants after conducting interviews. While the informant technique is carried out in a way, the initial sample determination is carried out using Purposive Sampling. Purposive sampling is the determination of samples by considering certain criteria, in this case the person who is considered to be a native of the Nubamado Village community who knows and who uses traditional medicine for livestock. The selected sample is called key informants who are important reflective members of a community who know a lot about the culture in the area and are willing to share their knowledge. After the initial observation, the next informant selection was carried out using the Snowball Sampling method, which is an informant selection technique based on the key informant's recommendation. Snowball sampling is a sampling technique where the initial sample is predetermined, then determines the next sample based on the information obtained (Kaunang et al., 2015).

The informants selected in this research are either natives of Nubamado Village or migrants who have their own empirical and cultural ecological knowledge. Data collection in this study was carried out through several techniques, namely semi-structured interviews with selected informants. Wild plant data, conducted through semi-structured interviews with selected resource persons and inventory in the forest, plant data in the home yard, conducted through semi-structured interviews with selected resource persons and inventory around the home yard or in the garden (Ulfa, 2021).

This research uses descriptive data analysis techniques, which is a technique in which data is collected in the form of words derived from interview sheets, notes at the research site and other official documentation so that it is clearer and can be distinguished between one specimen and another. The data obtained is presented in the form of descriptions, tables and images/photos of the types of medicinal plants found in Nubamado Village, Nubatukan District, Lembata Regency (Yowa et al., 2019).

The results of interviews with respondents will be recorded and then tabulated into tables and analyzed descriptively. Descriptive analysis in this study was used to describe the types of medicinal plants used and the parts of plants that are used as medicine (Wattimena et al., 2023).

III. RESULT AND DISCUSSION

A. General condition of the research site

Nubamado Village is a village located \pm 8 km from the sub-district capital and the capital of Lembata Regency. Generally, the livelihoods of the inhabitants of this area are farmers, ranchers, government employees. The religion practiced is Catholicism. Administratively, this village borders directly with: Lewoleba Village to the north, Baolangu Village to the south, Lite Ulumado Village to the east and Bakalerek Village to the west (Figure 1).

Diversity of Medicinal Plants in Nubamado Village, Lembata District to Cure Livestock Diseases

B. Respondent Characteristics

Title must be in 24 pt Regular font. Author name must be in 11 pt Regular font. Author affiliation must be in 10 pt Italic. Email address must be in 9 pt Courier Regular font.

1. Gender

Based on the results of interviews conducted with the people of Nubamado Village about the types of plants used to cure diseases in animals, 12 respondents were determined. Where the most respondents are dominated by men, because male respondents more often take care of livestock than female respondents (Figure 2).

2. Livelihood

Based on the results of the interviews, there are three groups of respondents' livelihoods: breeders, farmers and housewives (Figure 3). The majority of Nubamado villagers are livestock farmers, 58% (7 people). The involvement of farmers in utilizing medicinal plants in the forest is one way to maintain the security and sustainability of the forest because the community views the forest as a source of family economy, a source of medicine and as a maintainer of springs so as to ensure the sustainability of the lives of villagers around the forest [14].

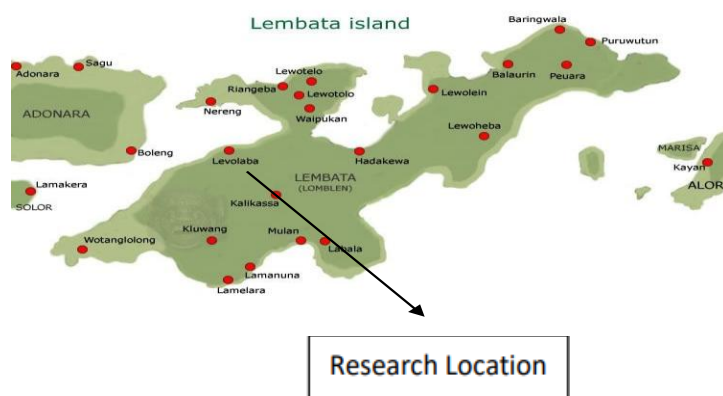

Figure 1 : Research Location Map

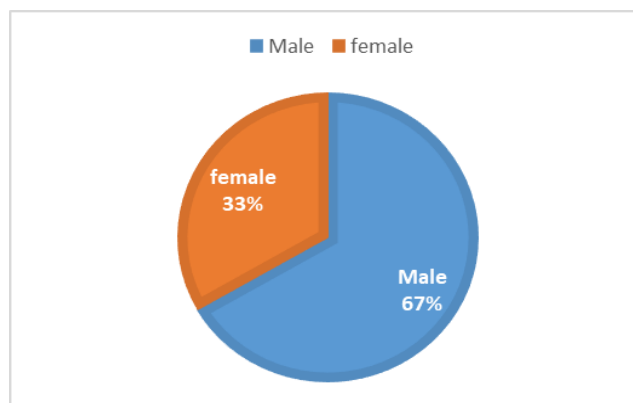

Figure 2: Gender presentation of the people of Nubamado Village

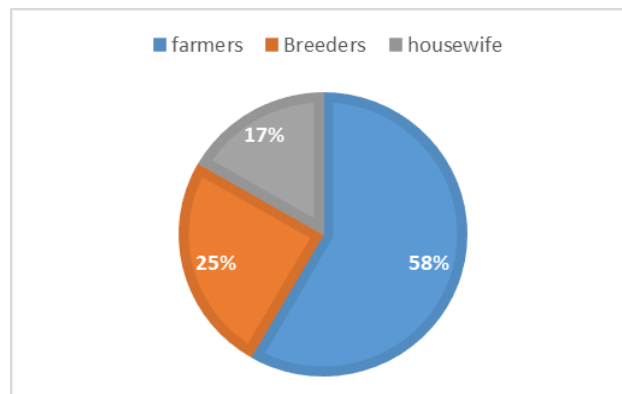

Figure 3 : Nubamado Livelihoods of the Nubamado Village Community

Diversity of Medicinal Plants in Nubamado Village, Lembata District to Cure Livestock Diseases

C. Ethnobotany of Medicinal Plants

Based on the results of interviews conducted with the people of Nubamado Village about the types of plants used to cure diseases in animals, 12 respondents were determined. The 12 respondents generally work as breeders and farmers who know and use plants for traditional treatment of livestock. There are 25 types of plants used by the people of Nubamado village as medicine. The plant data obtained can be seen in the table below.

Table 1 : Types of plants used to cure livestock diseases by the people of Nubamado village

No	Plant Name			Part of the plant used	Family
	Local	Indonesia	Scientific		
1	Kencur	Kencur	<i>Kaempferia galangal</i> L.	Rhizome	Zingiberaceae
2	Halia	Jahe	<i>Zingiber officinale</i> L.	Rhizome	Zingiberaceae
3	Kumah	Kunyit	<i>Curcuma domestica</i> L.	Rhizome	Zingiberaceae
4	Jambu mente	Jambu monyet	<i>Anacardium occidentale</i> L.	Skin	Anacardiaceae
5	Au	Bambu betung	<i>Dendrocalamus asper</i> S.	Leaves	Poaceae
6	Kwaror	Jagung	<i>Zea mays</i> L.	Leaves	Poaceae
7	Sereh	Sere	<i>Cymbopogon nardus</i> L.	Stems & leaves	Poaceae
8	Waru	Waru	<i>Hibiscus tiliaceus</i> L.	Skin	Malvaceae
9	Hure kayo	Ketela pohon	<i>Manihot esculenta</i> C.	Leaves	Euphorbiaceae
10	Hiler	Cabe	<i>Capsicum annum</i> L.	Leaves	Solanaceae
11	Tembako	Tembakau	<i>Nicotiana tabacum</i> L.	Leaves	Solanaceae
12	Malor	Sirih	<i>Piper betle</i> L.	Leaves	Piperaceae
13	Keleruk	Pinang	<i>Areca catechu</i> L.	Fruit	Arecaceae
14	Koler	Siwalan	<i>Borassus flabellifer</i> L.	fronds	Arecaceae
15	Tapor	Kelapa	<i>Cocos nucifera</i> L.	Fruit	Arecaceae
16	Lamatoro	Lamtoro	<i>Leucaena leucocephala</i> n.	Leaves	Mimosaceae
17	Rimba	Mimba	<i>Azadirachta indica</i> Juss.	Leaves	Meliaceae
18	Kesirem	Sembukan	<i>Paederia fortida</i> L.	Leaves	Rubiaceae
19	Mukor	Pisang	<i>Musa acuminata</i> L.	Trunk	Musaceae
20	Tobil	Asam jawa	<i>Tamarindus indica</i> L.	Fruit	Fabaceae

Diversity of Medicinal Plants in Nubamado Village, Lembata District to Cure Livestock Diseases

21	Uta tana	Kacang tanah	<i>Arachis hipogaea</i> L.	Leaves	Fabaceae
22	Hebawang	Bawang putih	<i>Allium sativus</i> L.	Tubers	Alliaceae
23	Mudai	Jeruk nipis	<i>Citrus aurantifolia</i> S.	Fruit	Rutaceae
24	Gewawas	Jambu biji	<i>Psidium guajava</i> L.	Leaves	Myrtaceae
25	Payam	Pepaya	<i>Carica papaya</i> L.	Leaves	Caricaceae

Some types of medicinal plants found are types that are cultivated outside the forest. Not all medicinal plants are cultivated by the community, only plant species that are easy to plant are cultivated by the community. People cultivate medicinal plants that can be cultivated so that it is easy to get them in times of urgency. Medicinal plants with tree habitats are rarely cultivated, this is in line with Sembiring et al (Sembiring Eva Friska Br , Indriyanto, 2015) who said that medicinal plants with tree habitats cannot grow well in unsuitable growing conditions and there is high competition between medicinal plants and other plants.

The part of the plant that is most often used by the community is the leaves, it can be seen in table 2, this is in line with Ulfa (Ulfa, 2021) who said that the use of leaves as ingredients in medicinal herbs is considered an easier way of processing than skin, stems and roots. Leaves are easy to take and have good properties compared to other parts and do not depend on the season, the use of leaves also does not damage other parts because the leaves easily grow back and can be used continuously.

Based on the data that has been obtained, it can be seen that the types of medicinal plants found in Nubamado village consist of different families.

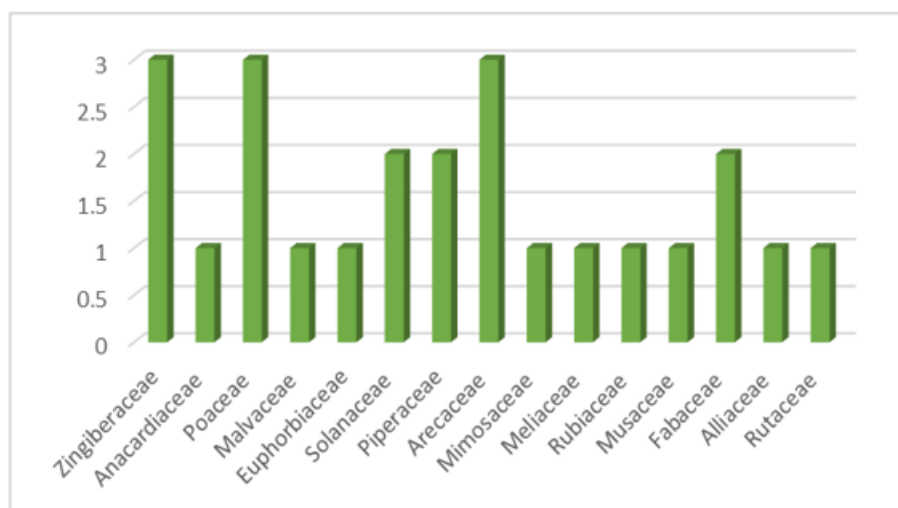

From the diagram above it can be seen that the Family Zingiberaceae, Poaceae, Arecaceae, is the Family that is most widely used as a medicinal plant in Nubamado village, this is in line with Rukmana and Zulkarnain (2022) who say that the Zingiberaceae plant tribe is widely used because the types of plants from the tribe are very familiar among the general public. the second most families are Solanaceae, Piperaceae and Fabaceae. The least family is Malvaceae, Euphorbiaceae, Piperaceae, Mimosaceae, Meliaceae, Rubiaceae, Musaceae, Alliaceae, Rutaceae, Myrtaceae, Caricaceae.

IV. CONCLUSIONS

Traditional wisdom that exists in the Nubamado village community is based on their dependence on the sustainability of the forest around their living environment. The utilization of medicinal plants by the people of Nubamado village is 25 species belonging to 15 families. Family Zingiberaceae, Poaceae, Arecaceae are families whose types are most widely used as medicinal plants. The most commonly used part of the plant is the leaf. The long interaction between the people of Nubamado village and the surrounding forest creates harmony, where the utilization of plant resources while maintaining the preservation of the surrounding environment.

With this ethnobotanical analysis of medicinal plants, it is hoped that it can help the community to be able to preserve culture in the surrounding environment, and can be used by people outside the village of Nubamado to cure diseases in livestock.

Diversity of Medicinal Plants in Nubamado Village, Lembata District to Cure Livestock Diseases

ACKNOWLEDGMENT

Thanks to Dr. Agung Wijaya Subiantoro as the supervisor who has guided the author, in the completion of this article.

REFERENCES

- 1) Ajeng, L., Marmaini, & Trimin, K. (2019). Inventarisasi Tumbuhan Berkhasiat Obat di Sekitar Pekarangan di Kelurahan Sentosa. *Indobiosains*, 1(2), 76–87.
- 2) Aziz, I. R., Rahajeng, A. R. P., & Susilo. (2018). Peran Etnobotani sebagai Upaya Konservasi Keanekaragaman Hayati oleh Berbagai Suku di Indonesia. *Prosiding Seminar Nasional Megabiodiversitas Indonesia*, 4 (1)(April), 54–57. <https://journal.uin-alauddin.ac.id/index.php/psb/article/view/9596>
- 3) Jalianery, J., & Evi. (2020). Perlindungan Hak Kekayaan Intelektual Bagi Tanaman Obat Tradisional Di Provinsi Kalimantan Tengah. *Jurnal Ilmu Hukum Tambun Bungai*, 5(2), 818–842. <https://doi.org/10.61394/jihtb.v5i2.149>
- 4) Jamun, R., Hendra, M., & Hariani, N. (2020). Keanekaragaman Tumbuhan Obat Di Suku Manggarai Kecamatan Ndosso Kabupaten Manggarai Barat Nusa Tenggara Timur (Ntt). *Jurnal Pendidikan Matematika Dan IPA*, 11(2), 271. <https://doi.org/10.26418/jpmipa.v11i2.40810>
- 5) Kaunang, I., Kanine, E., & Kallo, V. (2015). Hubungan Kepatuhan Minum Obat Dengan Prevalensi Kekambuhan Pada Pasien Skizofrenia Yang Berobat Jalan Di Ruang Poliklinik Jiwa Rumah Sakit Prof Dr. V. L. Ratumbusang Manado. *Jurnal Keperawatan UNSRAT*, 3(2), 107679.
- 6) Kementerian Lingkungan Hidup dan Kehutanan. (2023). Rencana Kerja Direktorat Bina Rencana Pemanfaatan Hutan 2023. *Direktorat Bina Rencana Pemanfaatan Hutan Kementerian Lingkungan Hidup Dan Kehutanan*, 2516061(287), 1–120. <https://disbudpar.acehprov.go.id/ppid/>
- 7) Mayrowani, H., & Ashari, N. (2016). Pengembangan Agroforestry untuk Mendukung Ketahanan Pangan dan Pemberdayaan Petani Sekitar Hutan. *Forum Penelitian Agro Ekonomi*, 29(2), 83. <https://doi.org/10.21082/fae.v29n2.2011.83-98>
- 8) Pranita, E. (2019). *Kepunahan Biodiversitas Tertinggi, Indonesia Peringkat Ke-6*. <https://nationalgeographic.grid.id/read/131833161/kepunahan-biodiver-sitas-tertinggi-indonesia-peringkat-ke-6>
- 9) Purwanti, Miswan, & Pitopang, R. (2017). Studi Etnobotani Pada Proses Ritual Adat Masyarakat Suku Saluan di Desa Pasokan Kabupaten Tojo Una-Una. *Jurnal Biocelebes*, 11(1), 46–60.
- 10) Qasrin, U., Setiawan, A., Yulianty, Y., & Bintoro, A. (2020). Studi Etnobotani Tumbuhan Berkhasiat Obat Yang Dimanfaatkan Masyarakat Suku Melayu Kabupaten Lingga Provinsi Kepulauan Riau. *Jurnal Belantara*, 3(2), 139–152. <https://doi.org/10.29303/jbl.v3i2.507>
- 11) Rukmana, R., & Zulkarnain, Z. (2022). Etnobotani Tanaman Obat Famili Zingiberaceae Sebagai Bahan Herbal Untuk Kesehatan Di Masa Pandemi Covid-19. *Teknosains: Media Informasi Sains Dan Teknologi*, 16(1), 74–80. <https://doi.org/10.24252/teknosains.v16i1.25970>
- 12) Sembiring Eva Friska Br , Indriyanto, dan D. (2015). *Keragaman Jenis Tumbuhan Obat Di Hutan Pendidikan Universitas Sumatera Utara Kawasan Taman Hutan Raya Tongkoh Kabupaten Karo Sumatera Utara*. 3(2), 113–122.
- 13) Ulfa, S. W. (2021). Inventarisasi Keanekaragaman Tumbuhan Obat di Kecamatan Medan Tembung Kota Medan Propinsi Sumatera Utara. *Best Journal (Biology Education Science & Tecnology)*, 4(1), 123–132.
- 14) Utami Revina Dwi, & Zuhud, E. A. M. (2019). Etnobotani dan Potensi Tumbuhan Obat Masyarakat Etnik Anak Rawa Kampung Penyangat Sungai Apit Siak Riau. *Jurnal Media Konservasi*, 24, 40–51.
- 15) Wattimena, N., Ndukang, S., & Missa, H. (2023). *IDENTIFIKASI JENIS TUMBUHAN OBAT TRADISIONAL YANG DI MANFAATKAN UNTUK MENGOBATI PENYAKIT PADA MANUSIA DI DESA NAITIMU KECAMATAN TASIFETO BARAT KABUPATEN BELU*. 01(03), 197–204. <https://journal.unwira.ac.id/index.php/JBIOEDRA>
- 16) Yowa, M. K., Boro, T. L., & Danong, M. T. (2019). Inventarisasi Jenis-Jenis Tumbuhan Berkhasiat Obat Tradisional Di Desa Uumbu Langang Kecamatan Uumbu Ratu Nggay Barat Kabupaten Sumba Tengah. *Jurnal Biotropikal Sains*, 16(1), 1–13.



There is an Open Access article, distributed under the term of the Creative Commons Attribution – Non Commercial 4.0 International (CC BY-NC 4.0)

(<https://creativecommons.org/licenses/by-nc/4.0/>), which permits remixing, adapting and building upon the work for non-commercial use, provided the original work is properly cited.

Comparison of PMH Arrangements in Indonesia and the Netherlands in Transportation Matters



Ni Kadek Manik Lely Kamani¹, Salsah Puri Dewi², Lorin Imogen³, Frity Felicia Anton⁴,
Giorgio Geissler Vallerio Tjua Mottoh⁵

^{1,2,3,4,5}Pelita Harapan University

ABSTRACT: This study aims to compare the regulation of Unlawful Acts (PMH) in the transportation sector in Indonesia and the Netherlands, in order to provide better policy recommendations. The method used is normative juridical with a comparative approach, through analysis of regulations and legal norms in both countries. The results show that the PMH system in the Netherlands, which applies the principle of strict liability, is more effective in handling transportation accident cases compared to Indonesia, which still relies on the element of fault. This results in a faster legal process in the Netherlands and better protection of victims. The implication of this finding is the need for reform in the regulation of PMH in Indonesia to be more responsive to the needs of modern society, as well as increasing public awareness of the importance of complying with traffic regulations. This research is expected to be a reference for policy makers in formulating more effective and efficient regulations in the transportation sector.

KEYWORDS: PMH, Netherlands, Indonesia, Comparison

I. INTRODUCTION

Transportation is one of the vital aspects of modern society because of its role as a link between regions as well as supporting social and economic mobility. In Indonesia, the transportation sector is experiencing rapid development, especially with increasing urbanization and people's need for fast and efficient services. However, this development is accompanied by significant challenges, such as congestion, high accident rates, and low efficiency of public transportation. These problems are exacerbated by the lack of effective policy implementation to improve transportation safety and convenience for the general public.

In contrast, the Netherlands is known for its integrated and efficient transportation system, which has undergone various innovations in both infrastructure management and legal policies. The country has strict and consistent regulations in maintaining transportation safety standards, supported by the application of the concept of *strict liability* in handling tort actions related to transportation accidents. The success of the transportation system in the Netherlands is a clear example of how good policy can reduce legal conflicts while improving service quality. Therefore, this study aims to compare the regulation of tort in the transportation context in Indonesia and the Netherlands, in order to provide recommendations for better policy development in the future.

The regulation of tort in Indonesia still refers to the Civil Code (KUHPer) which was adopted from the Dutch legal system during the colonial period. Article 1365 of KUHPer explicitly stipulates that any act that harms another person, whether intentional or negligent, is obliged to provide compensation. This regulation emphasizes the element of fault as an important element that must be proven by the plaintiff to obtain the right to compensation. However, the challenge faced in its application is the law's lack of flexibility to adapt to modern situations, including new cases in the transportation sector that require a more progressive legal approach (Soepomo, 2022).

In contrast, the Netherlands has developed the concept of PMH with a broader and more dynamic approach in line with the times. The Dutch legal system not only regulates liability for damages under the law, but also considers social norms and the principle of strict liability in certain cases, such as transportation accidents and environmental pollution. This makes it possible to resolve PMH cases without having to prove the element of fault, thus speeding up the legal process and protecting victims more effectively. This approach shows how the Netherlands is adapting the concept of PMH to support public policy and create a legal system that is more responsive to the needs of modern society.

Comparison of PMH Arrangements in Indonesia and the Netherlands in Transportation Matters

In the context of transportation, PMH regulation is very important to protect consumer rights and ensure the safety of road users. In Indonesia, although there are various regulations related to traffic safety and road transportation, implementation in the field is often less than optimal. This has led to many cases of traffic accidents and legal conflicts between transportation service providers and users (Nugroho, 2023). In contrast, the Netherlands has implemented a strict supervision system for transportation service providers as well as strict sanctions for violators.

One concrete example of PMH regulation in the transportation sector is the use of electric bicycles. In Indonesia, the use of electric bicycles is regulated through the Minister of Transportation Regulation Number 45 of 2020. However, this regulation still has weaknesses in terms of sanctions for violators of the rules (Hasim Purba, 2023). Meanwhile, the Netherlands has a more comprehensive regulation on electric vehicles that includes aspects of safety and legal responsibility.

The comparison between the two countries includes not only legal aspects but also the culture and habits of the people in using transportation modes. The Dutch tend to be more disciplined in complying with traffic regulations compared to Indonesians. This can be seen from the lower traffic accident rate in the Netherlands compared to Indonesia (Adji et al., 2022). This research uses a normative juridical method with a comparative approach to analyze the differences in PMH arrangements in the two countries. By understanding these differences, it is hoped that solutions can be found to improve the effectiveness of PMH regulation in Indonesia to be more in line with the best practices applied in the Netherlands.

In order to achieve this goal, this research will discuss several important aspects: first, the definition and scope of PMH in the context of transportation; second, an analysis of the existing regulations in Indonesia and the Netherlands; third, the impact of these regulations on road user safety; and finally, recommendations for improving the legal system in Indonesia based on the Dutch experience.

Thus, the results of this research are expected to contribute to the development of transportation law in Indonesia and become a reference for policy makers in formulating better regulations. This research also aims to increase public awareness of the importance of complying with traffic regulations for mutual safety.

II. METHODS

The research method used in this article is normative research, which focuses on analyzing the legal norms applicable in Indonesia and the Netherlands in the context of the regulation of Unlawful Acts (PMH) in the field of transportation. Normative research, or often referred to as doctrinal research, aims to review and analyze laws and regulations as well as legal principles relevant to the topic discussed. This method involves collecting data from primary legal sources, such as laws and government regulations, as well as secondary sources such as books, journals, and scientific articles that discuss issues related to PMH in transportation.

The data collection process was conducted through a literature study, in which the researcher studied various literatures related to PMH and transportation in both countries. Primary legal sources analyzed included the Civil Code (KUHP), Law No. 22/2009 on Road Traffic and Transportation, and other relevant regulations. In addition, the researcher also reviewed legal documents from the Netherlands to obtain a comprehensive picture of the regulation of PMH in that country (Soekanto & Mamudji, 2009).

After data collection, the analysis was conducted using a descriptive analysis approach to describe and compare PMH arrangements in Indonesia and the Netherlands. The researcher will evaluate the effectiveness of existing regulations and their impact on consumer safety and protection in the context of transportation. Thus, this research not only aims to identify the differences between the two legal systems, but also to provide recommendations for the improvement of the legal system in Indonesia based on the best practices applied in the Netherlands (Hanitijjo, 1980).

III. LITERATURE REVIEW

A. *The Concept of Unlawful Acts (PMH)*

Unlawful act (tort) is a legal concept that underlies many civil lawsuit cases in Indonesia. According to Article 1365 of the Civil Code, PMH is defined as "any act that violates the law and causes loss to another party requires the perpetrator to compensate for the loss." This definition emphasizes two main aspects, namely the existence of a violation of law and a concrete loss. This definition is rooted in the principle of personal responsibility and places causation as an important requirement in a PMH lawsuit (Halipah, et al. 2023).

Unlawful Acts (PMH) is a very important term in Indonesian civil law, specifically regulated in the Civil Code (KUHP). According to Article 1365 of KUHP, PMH is defined as any act that violates the law and causes harm to another person, which requires the perpetrator to compensate the injured party. This concept includes not only acts that violate the law, but also acts that are contrary to social norms and decency prevailing in society (Agustina, 2003).

Comparison of PMH Arrangements in Indonesia and the Netherlands in Transportation Matters

According to Agustina (2003), in his book *Unlawful Acts*, in determining an act so that it can be qualified as PMH, 4 conditions are required:

1. Contrary to the perpetrator's legal obligations;
2. Contrary to the subjective rights of others;
3. Contrary to decency;
4. Contrary to propriety, accuracy and prudence.

PMH in the Civil Code has several fundamental characteristics that include unlawful acts, wrongdoing (both intentional and negligent), real losses suffered by the victim, and a causal relationship between the unlawful act and the loss. These four elements must be met for an act to be categorized as PMH that can be legally challenged. These characteristics show the importance of the link between legal norms and individual responsibility for the consequences of their actions (Shelia, 2011).

To qualify an act as PMH, there are several elements that must be met. First, the act itself must exist. This means that without the act or omission of the perpetrator, there can be no PMH. Second, the act must be against the law, both formally and materially. This includes actions that are not in accordance with the provisions of written law or recognized social norms (Sitorus, 2021). Third, there is an element of fault from the perpetrator. This fault can be either intentional or negligent. In this context, the perpetrator is considered guilty if he or she acts intentionally to violate the law or if he or she is negligent in fulfilling his or her obligations so as to cause harm to others. Fourth is the loss suffered by the injured party. This loss may be material (such as loss of property) or immaterial (such as pain or suffering) (Nugroho, 2023). Finally, there is an element of causal relationship between the unlawful act and the loss suffered. This means that the loss suffered by the victim must be directly caused by the perpetrator's actions. Without this causal link, even if all other elements are met, PMH cannot be claimed (Adji et al., 2022).

Various legal experts have provided views on the concept of PMH and its relevance in the context of transportation law. Rosa Agustina emphasized that an understanding of PMH must be seen in the context of legal responsibility and consumer protection. She argues that the regulation of PMH must be able to protect individual rights while encouraging business actors to act responsibly (Agustina, 2003).

Meanwhile, Sitorus (2021) added that the expansion of the definition of PMH in jurisprudential practice shows that not only unlawful acts regulated by law can be categorized as PMH. Actions that are considered inappropriate in a social context can also be sanctioned based on the principles of social justice. This shows that the understanding of PMH continues to evolve in line with changing societal values.

The element of fault is a key element in PMH because it determines the responsibility of the perpetrator. Fault can be in the form of negligence or intentional actions that violate applicable legal norms. In the context of Indonesian law, the measure of fault often refers to the general standard of what is considered a reasonable action by a prudent person in a similar situation (Novianto, 2015).

Losses in PMH can be material, such as loss of money or property damage, or immaterial, such as emotional distress. The Civil Code recognizes the victim's right to sue for both types of loss, provided that the victim can prove that the loss was directly caused by the perpetrator's actions. The importance of this proof makes the role of the court very significant in assessing the validity of loss claims (Apriani, 2021).

Causal relationship is the connecting element between the perpetrator's actions and the losses suffered by the victim. In judicial practice, the causal relationship is often the most difficult element to prove because it involves an in-depth analysis of how certain actions directly or indirectly cause harm (Kalensang, 2016).

In the context of transportation, PMH regulation is very important because it is directly related to the safety of road users and consumer protection. For example, a traffic accident caused by driver negligence can be classified as PMH if it fulfills all of these elements. The victim of the accident is entitled to file a claim for compensation against the perpetrator under the provisions of PMH (Nugroho, 2023).

The concept of PMH in the transportation sector is not only regulated by national law, but is also affected by international legal norms. For example, the Montreal Convention regulates the responsibility of airlines in cases of losses suffered by passengers, which can be a reference in cases of transportation PMH in Indonesia. This legal harmonization shows that PMH has cross-border relevance.

Courts in Indonesia have developed a broader interpretation of PMH through jurisprudence. For example, in some cases, courts have recognized PMH claims even if the harm is not direct, as long as there are indications that the perpetrator's actions have breached certain legal obligations. This development reflects the law's adaptation to the dynamics of modern society.

Overall, the concept of PMH in the Indonesian Civil Code provides an important legal framework to deal with various offenses that cause harm. By strengthening the elements of fault, loss and causal link, and expanding its application to the transportation sector, Indonesian law can more effectively protect individual rights and promote social responsibility.

Comparison of PMH Arrangements in Indonesia and the Netherlands in Transportation Matters

In the Netherlands, a similar concept is known as *onrechtmatige daad*, where the regulation of liability in transportation is more integrated and clear than in Indonesia. This shows that the legal system in the Netherlands is more responsive to the development of public needs related to safety and consumer protection in the field of transportation (Soepomo, 2022). Thus, a deep understanding of the concept of PMH is essential to create an effective legal system that is responsive to the needs of society. This research aims to further explore how PMH regulation in Indonesia can be improved by referring to best practices from other countries such as the Netherlands.

B. Regulation of PMH in Indonesia

Unlawful acts in the context of transportation are governed by various regulations in Indonesia, with the main focus on Law No. 22/2009 on Road Traffic and Transportation. The articles in this law not only establish obligations for road users, but also include legal consequences for violations that harm other parties. As the main legal foundation, it underlines the importance of safety, security and legal responsibility in transportation activities (Nugroho, 2023).

Law No. 22/2009 regulates various activities related to road traffic and transportation, including the movement of vehicles, people and goods. Article 4 of this law emphasizes the importance of safety, order, and smoothness in traffic operations. In addition, the law also covers activities related to motor vehicle registration, traffic education, traffic management, and law enforcement (MoF, 2009). Thus, the regulation of PMH in the transportation sector is an integral part of the overall legal system that aims to protect the rights of road users (Andilolo, et al. 2024).

Law No. 22/2009 emphasizes legal liability for individuals or entities that violate traffic norms. For example, a driver who is negligent, exceeds the speed limit, or ignores traffic signs may be considered to have committed an offense that falls under the PMH category. The law explicitly provides for administrative and criminal sanctions for various offenses, thus providing legal protection to victims of traffic accidents.

In the context of Law No. 22/2009, PMH can occur when there is a violation of the provisions stipulated in the law that causes harm to another party. For example, if a driver breaks the posted speed limit and causes an accident, then the driver can be considered to have committed PMH. This includes all the elements necessary to claim PMH: the existence of a tort, fault of the perpetrator, harm to the victim, and a causal link between the act and the harm (Adji et al., 2022).

In addition to individuals, the law also highlights the responsibility of transportation operators. Transportation companies are responsible for ensuring that the vehicles they operate are roadworthy and that drivers have sufficient competence. Failure to meet these safety standards can be considered a form of PMH that can be sued civilly if it causes harm to passengers or third parties (Sudiro, 2023).

In addition to Law No. 22/2009, several other regulations also support the regulation of PMH in transportation, such as Government Regulation No. 37/2017 on Road Traffic and Transportation Safety and Law No. 8/1999 on Consumer Protection. These regulations complement the legal framework by providing more detailed guidance on safety aspects and protection of consumer rights in transportation services.

The concept of PMH is also closely related to consumer protection in transportation. For example, consumers who are harmed by the negligence of a transportation service provider, such as a bus that has an accident due to malfunctioning brakes, have a legal basis to sue the service provider. The Consumer Protection Law provides an additional legal basis for such cases (Nugroho, 2023).

One of the main challenges in regulating PMH in Indonesia is law enforcement. Law No. 22/2009 authorizes law enforcement officials to take action against traffic violations. However, implementation in the field often encounters obstacles such as the lack of adequate human resources and suboptimal law enforcement infrastructure (Nugroho, 2023). Sanctions for violators also vary, ranging from administrative to criminal sanctions, depending on the level of offense committed.

Although regulations have been established, the effectiveness of their implementation often faces obstacles. Key issues include low legal awareness in the community, lack of law enforcement by authorities, and limited supporting infrastructure such as CCTV to monitor traffic violations. This exposes the gap between idealized rules and implementation on the ground (Amri, 2024).

To support the effectiveness of Law No. 22/2009, various implementing regulations are required. There are around 58 implementing regulations that have been established to support the implementation of this law. These regulations cover various technical aspects such as roadworthiness requirements for motor vehicles, traffic management, and public transportation licensing (Legal Aid, 2023). The existence of these implementing regulations is very important so that the provisions in the law can be translated into daily practice.

Although Law No. 22/2009 has been well drafted, challenges in its implementation remain. One of the main problems is public awareness of the importance of complying with traffic regulations. Many road users still ignore traffic signs and regulations. This

Comparison of PMH Arrangements in Indonesia and the Netherlands in Transportation Matters

shows that the socialization of this law needs to be improved so that people better understand their rights and obligations as road users (Denni Aristonova, 2018).

Law No. 22 Year 2009 is considered to have weaknesses in accommodating the development of transportation technology, such as online ojek. This regulation does not fully cover the legal responsibility of digital platforms in PMH cases involving their driver-partners. This absence of specific rules creates new challenges in the transportation legal system (Gusnita, 2019).

Jurisprudence in Indonesia has also contributed to the development of PMH regulation in transportation. In some cases, courts have rendered decisions that expand the scope of perpetrators' liability, for example by including aspects of immaterial losses as part of compensation. This approach shows the flexibility of the law in dealing with various new situations (Dhermawan, 2020).

An analysis of the effectiveness of PMH arrangements in Law No. 22/2009 shows that although there are many theoretically sound provisions, the practice in the field is often not as expected. The high number of traffic accidents is an indicator that there are still shortcomings in the application of the law and public understanding of traffic safety (Nugroho, 2023). Therefore, periodic evaluations are needed to assess the extent to which this law can be effectively implemented.

PMH regulation also has direct implications for consumer protection in the transportation sector. In this context, the law gives passengers the right to obtain safe and comfortable services from transportation service providers. If violations occur that cause harm to passengers, they have the right to file a claim for compensation under the PMH provisions (Nugroho, 2023).

Overall, Law No. 22/2009 on Road Traffic and Transportation provides a comprehensive legal framework to regulate PMH in Indonesia. However, challenges in its implementation indicate the need for further efforts to increase public awareness as well as the effectiveness of law enforcement. Further research is needed to explore ways to improve the implementation of this law to provide maximum protection for road users.

C. *PMH Regulation in the Netherlands*

The regulation of unlawful acts in the Netherlands is regulated in the Burgerlijk Wetboek (BW), which is the civil code applicable in the Netherlands. BW covers various aspects of civil law, including legal responsibility in the context of transportation. In BW, there are elements that must be met for an act to be categorized as an unlawful act, such as the existence of an unlawful act, the fault of the perpetrator, loss to the victim, and a causal relationship between the act and the loss (Van der Walt, 2018). The regulation of unlawful acts (PMH) in the Netherlands is sourced from the Burgerlijk Wetboek (BW), especially in Book 6 which regulates the law of obligations and agreements. Article 162 of BW defines PMH as an act that violates legal norms or propriety that apply in society and results in loss to another party. This provision is the basis for legal responsibility, including in the context of transportation (Sitorus, 2021). There are several main elements that must be met to determine the existence of PMH according to BW, namely unlawful acts (*onrechtmatige daad*), error or negligence, loss, and a causal relationship between the act and the loss. These elements are similar to the concepts in the Civil Code, but the implementation approach is very different (Sari, 2020).

The Dutch transport regulations also include specific laws governing transport, such as the *Wet Personenvervoer* (Persons Transport Act) and the *Wegenverkeerswet* (Road Traffic Act). These regulations provide the legal framework for the operation of public transport and the responsibilities of transport service providers towards passengers. For example, the Dutch Persons Transport Act requires public transport service providers to ensure the safety and comfort of passengers and to be liable for any damage that may occur due to their negligence (Van der Walt, 2018). In addition to the Road Traffic Act, the Netherlands also has specific regulations related to traffic safety, such as the *Wegenverkeerswet* (WW) which regulates the behavior of road users and liability in traffic accidents. This regulation focuses on protecting vulnerable road users, such as pedestrians and cyclists, who are often victims of accidents (Harsa, et al., 2023).

The Netherlands is known for its proactive approach to traffic safety. The Dutch government has implemented various policies to reduce the number of traffic accidents through traffic education, public awareness campaigns, and strict law enforcement against traffic violators. For example, the use of surveillance cameras to detect traffic violations such as speeding or running red lights is one effective way to reduce the number of accidents (Soepomo et al., 2022).

The Netherlands also places great emphasis on consumer protection in transportation services. European Union regulations implemented in the Netherlands, such as Regulation (EC) No. 261/2004 on passenger rights, provide compensation rights to passengers who experience delays or cancellations. This shows that the PMH Law in the Netherlands is not only national in nature, but also follows international standards (Drajad, 2012).

In the context of consumer protection, Dutch law provides guarantees for public transport passengers to receive safe and quality services. If there is a violation of consumer rights, they can file a claim for compensation based on the PMH provisions in the BW. This shows that the Dutch legal system does not only focus on the criminal aspect, but also provides protection to individuals as consumers (Van der Walt, 2018).

Comparison of PMH Arrangements in Indonesia and the Netherlands in Transportation Matters

In the Netherlands, technology is widely used to support transportation law enforcement. Traffic cameras, digital monitoring systems, and accident reporting applications help gather evidence to prove the existence of PMH. This is different from Indonesia, where the use of technology is still limited (Sakti & Haniyah, 2024).

The Netherlands emphasizes a preventive approach in regulating transportation law. Strict vehicle safety regulations and mandatory training for professional drivers are examples of how Dutch law seeks to prevent PMH before an accident occurs. This approach reduces the number of accidents due to negligence (Linanda, 2023).

Although PMH regulations in the Netherlands are quite comprehensive, there are still challenges in their implementation. One of the main problems is public awareness of their rights and obligations as road users. Although the government is actively disseminating information about traffic safety, many road users still ignore traffic regulations. Therefore, further efforts are needed to increase public awareness of the importance of obeying traffic regulations.

IV. RESULTS AND DISCUSSION

This study aims to compare the regulation of Unlawful Acts (IAC) in Indonesia and the Netherlands in the context of transportation. The results of the analysis show that although both countries have a good legal framework related to IAC, the effectiveness of law enforcement and public awareness of traffic regulations differ significantly.

In Indonesia, IAC is regulated in the Civil Code (KUHPer) and Law Number 22 of 2009 concerning Road Traffic and Transportation. These provisions explain that any individual or legal entity who commits an act that harms another party due to negligence or error can be held accountable based on the IAC principle. For example, if a driver ignores traffic signs and causes an accident, he can be held liable for compensation to the accident victim (Nugroho, 2023).

The elements of IAC in Indonesia include the existence of an unlawful act, the perpetrator's fault, the victim's loss, and the causal relationship between the act and the loss. These elements are in line with the provisions in the KUHPer which regulate liability for compensation. However, the implementation of Law No. 22 of 2009 often encounters obstacles, such as lack of law enforcement and low public awareness of traffic regulations (Adji et al., 2022).

The main challenge in implementing Law No. 22 of 2009 is the low level of public compliance with traffic regulations. Many road users still violate traffic signs, increasing the risk of accidents. Weak law enforcement is also a contributing factor to the high number of violations. Therefore, intensive efforts are needed to increase public awareness of the importance of complying with traffic regulations and strengthening law enforcement with strict sanctions for violators (Aristonova, 2018).

In the Netherlands, the regulation of PMH in the context of transportation is regulated in the Burgerlijk Wetboek (BW) and special laws such as Wegverkeerswet. BW provides a clear legal framework regarding the responsibilities of perpetrators in PMH cases, including the obligation to provide compensation to parties who are harmed due to negligence or error. The Dutch legal system is more structured and has clearer procedures for handling PMH cases (Van der Walt, 2018).

The elements of PMH in the Netherlands are the same as in Indonesia, namely the existence of an unlawful act, the fault of the perpetrator, the loss to the victim, and the causal relationship between the two. However, the Dutch legal system is more effective in enforcing the law by using technology such as surveillance cameras to detect traffic violations. This increases the effectiveness of law enforcement and reduces the rate of traffic accidents (Soepomo et al., 2022).

Law enforcement in the Netherlands regarding PMH is carried out strictly by the police and other related institutions. Sanctions for violators can be in the form of fines or imprisonment depending on the level of violation committed. This strict law enforcement creates a deterrent effect for violators and increases public compliance with traffic regulations (Nugroho, 2023).

The Netherlands is known for its proactive approach to traffic safety. The Dutch government has implemented various policies to reduce the number of accidents through traffic education and public awareness campaigns. The use of technology such as surveillance cameras also helps in enforcing traffic laws effectively. As a result, the Netherlands has a relatively low accident rate compared to Indonesia (Soepomo et al., 2022).

Consumer protection is also a top priority in Dutch transportation law. The law provides guarantees for public transport passengers to receive safe and quality services. If there is a violation of consumer rights, they can file a claim for compensation based on the provisions of the PMH in the BW (Van der Walt, 2018).

The analysis conducted shows that although both countries have good regulations in theory, implementation challenges remain a major issue, especially in Indonesia. In Indonesia, the lack of law enforcement and low public awareness of traffic regulations are major obstacles. Meanwhile, the Netherlands shows a more effective system with stricter law enforcement and higher public awareness (Adji et al., 2022).

The regulation of unlawful acts (PMH) in the transportation sector in Indonesia and the Netherlands shows fundamental differences that originate from the legal background of the two countries. Indonesia refers to Article 1365 of the Civil Code (KUHPerdata), which refers to the principle of liability based on actual losses. In contrast, the Netherlands applies Article 6:162 of

Comparison of PMH Arrangements in Indonesia and the Netherlands in Transportation Matters

the Dutch Civil Code which introduces the concept of relativity, namely that PMH lawsuits must meet the criteria for the conformity of certain legal norms. This reflects the Dutch legal approach which is more focused on the impact on the socio-legal order, in contrast to Indonesia's focus on individual losses (Snijders, 2021).

In practice, PMH regulations in the transportation sector in Indonesia face major obstacles, such as weak law enforcement against violations on the highway. Traffic accident cases, for example, are often processed slowly due to the lack of supporting legal infrastructure. In contrast, the Netherlands has a well-regulated transport system, supported by regulations that clarify the responsibilities of all parties involved, from operators to the government. In the Netherlands, PMH also includes preventive responsibilities, such as the obligation of transport companies to ensure the safety of vehicles before operating (Kottenhagen, 2007). One important aspect of PMH transport is dispute resolution. In Indonesia, dispute resolution often takes a long time due to the reliance on the litigation process. This is exacerbated by the lack of competent mediation institutions to handle transport cases. In contrast, in the Netherlands, there is a mediation-based approach that allows for faster resolution at lower costs. Mediation in the Netherlands is facilitated by special legislation that ensures all parties receive fair legal protection (Dewi, 2021).

In the context of public transportation, Indonesia faces challenges related to the regulation of operator liability. When an accident occurs, liability is often unclear, which causes legal uncertainty for victims. In the Netherlands, regulations are more specific, including a compensation system that automatically provides compensation to victims, without requiring a lengthy legal process. This system utilizes a national compensation fund managed by the government, so that victims do not have to wait for legal settlement to obtain their rights (Widihartanta, 2023).

The application of technology in transportation is also a major difference between Indonesia and the Netherlands. In the Netherlands, technologies such as early accident detection systems and AI-based traffic surveillance have been integrated into the PMH regulation. This allows for early prevention of legal violations while facilitating accident case investigations. In Indonesia, although similar technology has begun to be introduced, its implementation is still limited due to the lack of supporting regulations and adequate infrastructure (Supena, 2023).

The social aspect of PMH also has a significant impact, especially in the transportation sector. In Indonesia, transportation violations often have a wide impact on society, such as traffic congestion caused by accidents. This is not only economically detrimental but also reduces the productivity of society as a whole. In contrast, the Netherlands has managed to minimize social impacts through an efficient and sustainable public transport system. Strict regulations ensure that all parties comply with safety and operational standards.

Based on the results of this study, there are several recommendations to improve the regulation of PMH in Indonesia. First, there needs to be increased socialization regarding the importance of traffic safety to the public. Second, law enforcement must be strengthened with strict sanctions for violators. Third, the use of technology in traffic monitoring must be improved to support law enforcement (Aristonova, 2018).

Overall, although the basic principles of PMH in Indonesia and the Netherlands are similar, implementation and supervision in the field show significant differences. The Netherlands, with a technology-based legal approach and strict regulations, is able to create a safer and more efficient transportation system. Indonesia can learn from this experience, especially in strengthening regulations and legal infrastructure in the transportation sector.

Although the Dutch legal system is quite good, periodic evaluations are still needed to adjust regulations to developments and the needs of society. This includes paying attention to changes in road user behavior patterns and developments in transportation technology. Regular evaluations will help ensure that the legal system remains responsive to the needs of society (Van der Walt, 2018).

V. CONCLUSIONS

This study shows that the regulation of PMH in the context of transportation in Indonesia and the Netherlands has significant differences in terms of the effectiveness of law enforcement and public awareness of traffic regulations. Although both countries have good regulations in theory, the challenge of implementation remains a major issue, especially in Indonesia. The implications of this study suggest that policymakers need to consider best practices from other countries such as the Netherlands to improve the transportation legal system in Indonesia. This is important in order to create a safer and more efficient transportation environment for all road users.

ACKNOWLEDGMENT

The author would like to thank the research institutions that have provided financial support and research facilities that have greatly assisted in the implementation of this research.

Comparison of PMH Arrangements in Indonesia and the Netherlands in Transportation Matters

REFERENCES

- 1) Adji, S. U., & Nugroho, S. S. (2022). Hukum Pengangkutan: Teori dan Praktik. Jakarta: Rineka Cipta.
- 2) Agustina, R. (2003). *Perbuatan Melawan Hukum*. Pasca Sarjana Universitas Indonesia.
- 3) Amri, N.M. (2024). Efektivitas Program Electronic Traffic Law Enforcement dalam Penegakan Hukum Peraturan Berlalu Lintas di Kota Jambi. Universitas Jambi. Skripsi.
- 4) Andilolo, J.P, Tuasikal, H, Markus, D.P. (2024). Implementasi Hukum Lalu Lintas dalam Undang-Undang Nomor 22 Tahun 2009 Tentang Lalu Lintas dan Angkutan Jalan. *Jurnal Unes Law Review*, 6(4). Pp. 11717-11729.
- 5) Apriani, T. (2021). Konsep Ganti Rugi dalam Perbuatan Melawan Hukum dan Wanprestasi serta Sistem Pengaturannya dalam KUH Perdata. *Jurnal Ganec Swara*, 15(1), pp. 929-934.
- 6) Aristonova, D. (2018). Perlindungan Hukum Bagi Penumpang Jasa Angkutan Orang Dengan Kendaraan Bermotor Umum Dalam Trayek Berdasarkan Undang-Undang No 22 Tahun 2009 Tentang Lalu Lintas Dan Angkutan Jalan.
- 7) Bantuan Hukum. (2023). Implementasi Undang-Undang Nomor 22 Tahun 2009 Tentang Lalu Lintas dan Angkutan Jalan Raya.
- 8) Dewi, P.E. (2021). The Cross-Border Insolvency in the Execution of Bankrupt Assets outside Indonesian Jurisdiction: A Comparative Study with Malaysia, Singapore, and the Philippines. *The Indonesian Journal of Southeast Asian Studies*, 5(1).
- 9) Dhermawan, D. (2020). Tanggung Jawab Perusahaan Angkutan Darat Kepada Pihak Ketiga atas Perbuatan Melawan Hukum yang dilakukan Pegawainya (Studi Kasus Terhadap Putusan MA Nomor 04/Pdt.G/2013/PN.Psr). Universitas Mataram. Skripsi.
- 10) Drajad, V.W. (2012). Analisis Pemberian Ganti Rugi Kepada Penumpang Pesawat Udara Akibat Keterlambatan Penerbangan Oleh Maskapai Penerbangan di Indonesia dan Belanda. Universitas Indonesia. Skripsi.
- 11) Gusnita, A. (2019). Evaluasi Pro Kontra Transportasi Online.
- 12) Halipah, G. et al. (2023). Tinjauan Yuridis Konsep Perbuatan Melawan Hukum dalam Konteks Hukum Perdata. *Jurnal Serambi Hukum*, 16(1), pp. 138-143.
- 13) Hanitijjo, R. (1980). *Metodologi Hukum Dan Juri Metri*. Ghalia Indonesia.
- 14) Harsa, A., Marzuki & Purba. (2023). Analisis Yuridis Pelaksanaan Restitusi Terhadap Korban Luka Berat dalam Tindak Pidana Lalu Lintas Jalan Raya (Studi Di Satuan Lalu Lintas Kepolisian Resor Kota Banda Aceh). *Jurnal Meta Hukum*, 2(3), pp. 91-102.
- 15) Kalensang, A. (2016). Hubungan Sebab Akibat (Causaliteit) dalam Hukum Pidana dan Penerapannya dalam Praktek. *Jurnal Lex Crimen*, 5(7), pp. 12-19
- 16) Karim, L., Cahyono, S., Syahrin, M. (2024). Innovations in Legal Management Transforming The Role of Law Departments in Organisations. *International Journal of Social and Education*, 1(5).
- 17) Kottenhagen, R & Kottenhagen-Edzes, P. (2007). *Tort and Regulatory Law*. Rotterdam Institute of Private Law Accepted Paper Series
- 18) Kemenkeu. (2009). Undang-Undang Republik Indonesia Nomor 22 Tahun 2009 Tentang Lalu Lintas Dan Angkutan Jalan.
- 19) Linanda. (2023). Rekonstruksi Regulasi Electronic Traffic Law Enforcement (ETLE) Berbasis Nilai Keadilan. Universitas Islam Sultan Agung Semarang. Disertasi.
- 20) Novianto, W.T. (2015). Penafsiran Hukum dalam Menentukan Unsur-Unsur Kelalaian Malpraktek Medik (Medical Malpractice). *Jurnal Yustisia*, 4(2), pp. 488-503.
- 21) Nugroho, S. S. (2023). Analisis Pengaturan Lalu Lintas di Indonesia: Tantangan dan Solusi. *Jurnal Ilmu Hukum De'Jure*.
- 22) Purba, H. (2023). Hukum Pengangkutan di Laut. Medan: Pustaka Bangsa Press.
- 23) Sakti, H.A & Haniyah. (2024). Pelaksanaan Sistem Electronic Traffic Law Enforcement (E-Tle) Menggunakan Pengawasan CCTV Lalu Lintas Dalam Upaya Penertiban Pengguna Jalan Di Kota Surabaya Pusat. *Socius: Jurnal Penelitian Ilmu-Ilmu Sosial*, 1(7), pp. 140-147.
- 24) Sari, (2020). Perbuatan Melawan Hukum (PMH) dalam Hukum Pidana dan Hukum Perdata. *Jurnal Ilmiah Hukum Dirgantara–Fakultas Hukum Universitas Dirgantara Marsekal Suryadarm*, 11(1), pp. 53-71.
- 25) Shelia, P. (2011). Studi Komparatif Perbuatan Melawan Hukum dalam Kitab Undang-Undang Hukum Perdata dengan The Law of Tort Inggris (Penerapan dalam Malpraktek Medis). Universitas Indonesia. Skripsi.
- 26) Sitorus, P. (2021) "BUY SPEAR FROM SIDE OR BEAR IT: KAJIAN KOMPARATIF PENGATURAN PERBUATAN MELAWAN HUKUM DI INDONESIA DAN BELANDA," Dharmasisya: Vol. 1 , Article 30.
- 27) Snijders, H. (2021). NETHERLANDS HUKUM BELANDA LAW OF PROPERTY TENTANG HARTA KEKAYAAN. *E-Datun*.
- 28) Soekanto, S., & Mamudji, S. (2009). *Penelitian Hukum Normatif Suatu Tujuan Singkat*. PT Raja Grafindo Persada.
- 29) Sudiro, A & Atmaja, R. (2023). Mengevaluasi Tanggung Jawab Maskapai Penerbangan dan Kompensasi dalam Penerbangan Indonesia. *Jurnal Rechtsidee*, 11(2), pp. 1-14.

Comparison of PMH Arrangements in Indonesia and the Netherlands in Transportation Matters

- 30) Van der Walt, A.J. (2018). *Introduction to Dutch Law* (Edisi Ketiga). The Hague: Boom Legal Publishers.
- 31) Widihartanta, D. (2023). Implementasi Hak Asasi Manusia terhadap Perlindungan Hukum Melalui Asuransi Kepada Korban Atau Ahli Waris Akibat Kecelakaan Lalu Lintas. Universitas Darul Ulum Islamic Centre Sudirman Guppi. Skripsi.
- 32) Wisnu M.P. (2018). *Asas-asas Hukum Pengangkutan*. Fakultas Hukum UMP.



There is an Open Access article, distributed under the term of the Creative Commons Attribution – Non Commercial 4.0 International (CC BY-NC 4.0) (<https://creativecommons.org/licenses/by-nc/4.0/>), which permits remixing, adapting and building upon the work for non-commercial use, provided the original work is properly cited.

Substantive and Procedural Justice Principles in the Implementation of Industrial Court Decisions: Challenges and Solutions



Muhammad Ramdan¹, Ardina Nur Amalia²

^{1,2}Faculty of Law, Universitas Diponegoro, Semarang 50275, Indonesia

ABSTRACT: The issues related to the execution of industrial relations court decisions often involve delays in implementing decisions and resistance from employers that can postpone or avoid the execution of decisions. Additionally, discrepancies between court rulings and field implementation frequently occur due to inadequate law enforcement and weak supervision. The research questions in this study are: How do the principles of substantive justice and procedural justice apply to the implementation of industrial relations court decisions? And what are the challenges and solutions in the implementation of industrial relations court decisions? This research is classified as normative legal research. The approach used in this research is the statute approach. Data collection is conducted through literature study, and data analysis is performed descriptively. Substantive justice requires that industrial relations court decisions reflect a fair distribution of rights and obligations, such as compensation and the restoration of rights for workers unfairly dismissed. Procedural justice emphasizes an equitable and transparent decision-making process, which is related to the effective implementation of decisions. Major challenges in implementing decisions include delays, employer resistance, and discrepancies in implementation, while solutions involve strengthening law enforcement, simplifying legal processes, education, socialization, and alternative dispute resolution mechanisms.

KEYWORDS: Substantive Justice, Procedural Justice, Industrial Relations Court Decisions.

I. INTRODUCTION

Industrial relations is a crucial aspect of the employment system that ensures a balance of rights and obligations between employers and employees. In Indonesia, industrial courts play a key role in resolving labor disputes and ensuring the enforcement of labor laws. One of the primary objectives of these courts is to guarantee that decisions reflect fairness for all parties involved. In this context, two main principles that must be observed are substantive justice and procedural justice.

Substantive justice focuses on the outcome or content of the court's decisions. This principle requires that the results of the decisions align with the rights and obligations established by applicable laws and are fair to all parties. The decisions must reflect a deep understanding of the case facts and relevant laws. It is important to ensure that both workers' and employers' rights are respected and fulfilled in a balanced and equitable manner.

However, the application of substantive justice in practice often faces various challenges. Industrial relations cases frequently involve many complex aspects, such as labor regulations, employment contracts, and interpersonal relationships. This complexity makes fair assessment difficult. Additionally, issues related to information gaps arise, where parties in disputes may lack adequate access to relevant information or evidence needed to defend their rights.

On the other hand, procedural justice concerns how the judicial process is conducted. This principle emphasizes that the decision-making process must be fair and transparent, providing equal opportunities for all parties to present their views and evidence. A fair process not only ensures that the decisions made are substantive but also strengthens public trust in the judicial system.

However, challenges to procedural justice are also significant. Complicated and unclear court procedures can hinder parties in a dispute from effectively participating in the judicial process. A lack of transparency in the judicial process can also lead to mistrust in the outcome, especially if there is a perception that the process is unfair or influenced by external interests.

Substantive and Procedural Justice Principles in the Implementation of Industrial Court Decisions: Challenges and Solutions

Inequality in access to justice is also a critical issue. Parties with more resources may have an advantage in legal proceedings compared to those with fewer resources. This can create unfairness in the judicial process and disadvantage those who are less able to effectively defend their rights.

In addressing these challenges, it is important to seek effective solutions to ensure that both substantive and procedural justice principles are well applied. For example, enhancing judges' and lawyers' understanding of these principles through training and education could help. Additionally, ensuring adequate access to information for all parties and establishing independent oversight mechanisms to prevent external influences are also crucial steps.

Furthermore, efforts to simplify legal procedures and improve transparency in the judicial process can help address challenges related to procedural justice. This way, all parties in a dispute can better understand the judicial process and participate effectively.

Overall, addressing these challenges and implementing appropriate solutions will help improve the quality and fairness of industrial court decisions. This will not only enhance the industrial relations court system but also contribute to the creation of a more just and sustainable industrial relations environment in Indonesia.

Based on the background above, the research questions in this study are: How are substantive and procedural justice principles applied in the implementation of Industrial Court decisions? And what are the challenges and solutions in the implementation of Industrial Court decisions?

II. RESEARCH METHODS

This research is a type of normative legal research, namely legal research that places law as a building system of norms consisting of principles, norms, rules and regulations, court decisions, agreements, and doctrine. The approach used in this research is the statute Approach, which is an approach that uses regulations. The data collection technique used is literature study. Data analysis is conducted descriptively. Descriptive analysis means that the author provides an explanation of the subject and object of the research based on the results obtained from the study.

III. RESULTS AND DISCUSSION

PRINCIPLES OF SUBSTANTIVE AND PROCEDURAL JUSTICE IN THE IMPLEMENTATION OF INDUSTRIAL COURT DECISIONS

1. Substantive Justice

Substantive justice is a principle that measures fairness based on the final outcome of a decision or policy, rather than just the process or procedures used to reach it. This principle emphasizes the content of the decision's outcome and the equitable and fair distribution of rights and obligations.

According to Rawls (1971), substantive justice involves two main principles: the principle of equality and the principle of difference. The principle of equality states that each individual should have the same rights to equal freedoms. The principle of difference allows inequalities only if they benefit the least advantaged positions in society.

In the context of public policy, substantive justice assesses whether a policy effectively reduces inequality and provides fair benefits to all parties. For example, a wealth distribution policy aimed at reducing the economic gap between the rich and the poor can be evaluated in terms of substantive justice if it effectively improves the well-being of the less fortunate groups.

Substantive justice measures fairness based on the final outcomes of decisions or policies, not just the process. In the context of industrial relations, this principle ensures that court decisions are not only fair in their procedures but also in their results.

Substantive justice requires that court decisions in industrial relations reflect a fair distribution of rights and obligations. For instance, if a worker is unfairly dismissed, the court's decision should provide fair compensation and restore the worker's rights equitably. According to Rawls (1971), the principle of substantive justice ensures that decision outcomes benefit the least advantaged positions.

In industrial relations, substantive justice necessitates attention to the specific conditions of the parties involved. This includes factors such as working conditions and the social impact of decisions. Sen (2009) emphasizes the importance of considering the social and economic context in the assessment of substantive justice.

The implementation of Industrial Court decisions must align with the principles of substantive justice. Nussbaum (2000) highlights the importance of effectively implementing the rights recognized by decisions to ensure substantive justice. Substantive justice also balances competing interests between workers and employers, striving to find fair solutions for all parties. This aligns with the principles discussed by Rawls (1971), where decisions must consider the well-being of all parties, especially the least advantaged.

Substantive and Procedural Justice Principles in the Implementation of Industrial Court Decisions: Challenges and Solutions

Decisions that meet the standards of substantive justice are likely to be more accepted by the involved parties, reducing the risk of prolonged conflicts. This supports more efficient dispute resolution, consistent with Sen's (2009) theory of justice in a social context.

An example of substantive justice in unilateral termination of employment involves a fair assessment of the reasons for termination, as well as the compensation or rights of workers that must be fulfilled. Court decisions should consider the rights and obligations of both parties.

2. Procedural Justice

Procedural justice and the implementation of court decisions in industrial relations are closely related, as procedural justice focuses on how decisions are made, while the implementation of decisions concerns applying those outcomes in practice. Procedural justice ensures that the decision-making process is conducted fairly, transparently, and inclusively, while the implementation of decisions aims to apply those decisions fairly and effectively.

Procedural justice refers to the principle that decision-making processes should be conducted fairly, transparently, and accessibly. In the context of industrial relations, this includes the right to be heard, equal access to information, and impartial procedures. There are several ways in which procedural justice and the implementation of Industrial Court decisions are interconnected, as follows:

a. Fair and Transparent Processes

Procedural justice ensures that decision-making processes are conducted in a fair and transparent manner, providing all parties with an equal opportunity to present their arguments and evidence. When the Industrial Court adheres to procedural justice principles, the implementation of its decisions is more likely to be accepted by all parties because the process is perceived as fair. According to Lind and Tyler (1988), procedural justice contributes to the acceptance of decisions by increasing trust in the process.

b. The Right to Be Heard

In industrial relations, the right to be heard is a crucial element of procedural justice. If parties feel that they have been given a fair opportunity to present their views, they are more likely to comply with and implement the issued decisions. Tyler (2006) emphasizes that procedural justice enhances compliance with decisions because parties feel the process is fair and represents their interests.

c. Oversight and Accountability

Procedural justice also includes mechanisms for oversight and accountability to ensure that decisions are applied fairly. Transparent and monitored implementation of decisions enhances trust in the judicial system and reduces the potential for additional disputes. According to Thibaut and Walker (1975), procedural justice plays a vital role in reducing dissatisfaction and post-decision conflicts by ensuring that decisions are made through accountable processes.

d. Prevention of Deviations

By applying the principles of procedural justice, courts can prevent deviations and injustices in the implementation of decisions. A fair process ensures that decisions are not only legally valid but also substantively fair. Lind and Tyler (1988) explain that fair procedures help reduce the likelihood of dissatisfaction by providing adequate procedures for all parties.

e. Compliance and Law Enforcement

Compliance with court decisions greatly depends on the belief that the judicial process was fair. Procedural justice supports law enforcement by ensuring that all parties perceive the decision-making process as fair, which in turn enhances compliance with the decisions. Tyler (2006) shows that a fair process leads to outcomes that are more accepted and easier to implement.

CHALLENGES AND SOLUTIONS IN THE IMPLEMENTATION OF INDUSTRIAL COURT DECISIONS

1. Challenges

a. Delays in the Execution of Decisions

Delays in the execution of decisions occur when the implementation of court decisions is not carried out within the specified time frame or experiences postponements. This can be caused by various administrative factors or resistance from the involved parties.

Several factors contribute to delays in the execution of decisions, including:

- 1) **Slow Bureaucracy:** Complex administrative procedures often lead to delays in decision execution.
- 2) **Resistance from Parties to the Decision:** The losing party may delay the implementation of the decision through various means, including appeals or non-compliance with orders.

Substantive and Procedural Justice Principles in the Implementation of Industrial Court Decisions: Challenges and Solutions

3) Lack of Resources: Limitations in resources for implementing decisions, such as manpower or budget constraints, can cause delays.

The impact of slow decision execution affects workers, employers, and the judicial system. For workers, the economic well-being is at stake as those disadvantaged may experience financial difficulties if favorable decisions are not implemented promptly. Additionally, the uncertainty and delays can exacerbate stress and emotional pressure on workers.

For employers, the impact involves reputational damage, as delays in decision implementation can harm their reputation and lead to further conflicts. There are also additional costs, as delays may incur extra expenses such as fines or interest on unpaid compensation.

For the judicial system, the impact relates to public trust. Delays can erode public confidence in the judicial system and its effectiveness. Moreover, they disrupt the efficiency of the legal system and contribute to a backlog of cases.

The aspects causing delays in the execution of decisions include:

- 1) Procedural Aspects: Complex legal procedures that take time to follow can lead to delays. Additionally, limitations in court administration, such as delays in registration or other administrative processes, can hinder implementation.
- 2) Involved Parties Aspects: The losing party often files appeals or other legal measures to delay execution. Moreover, a lack of cooperation or non-compliance from the involved parties can slow down the execution process.
- 3) External Aspects: Limited resources available for executing decisions, such as funding or manpower, can cause delays. Additionally, external factors such as economic crises or natural disasters can impact the execution of decisions.

b. Resistance from Employers to the Implementation of Court Decisions

Resistance from employers to the implementation of court decisions often poses a significant issue within the legal system. This non-compliance can negatively impact the fairness and efficiency of the judicial system. Research indicates that employers frequently seek various methods to avoid or delay the implementation of decisions, whether through legal procedures or negotiation strategies. This may include requests for postponements, appeals, or attempts to file new lawsuits related to the same issue.

One of the primary reasons for this resistance is the economic burden incurred by employers as a result of implementing the decision. Some employers perceive that the cost of complying with the decision is much higher compared to the cost of delaying its execution. Additionally, this resistance can also stem from legal uncertainty or a lack of clarity in legal implementation, providing employers with reasons to postpone compliance.

c. Discrepancies Between Court Rulings and On-the-Ground Implementation

Discrepancies between Industrial Court rulings and on-the-ground implementation refer to issues that arise when the decisions made by the industrial court are not fully applied or do not align with the practical realities in the field. Industrial relations in Indonesia are governed by Law No. 13 of 2003 on Manpower, which provides a dispute resolution mechanism between employers and employees through the industrial court. However, there are often discrepancies between court decisions and their implementation.

The Industrial Court, under Law No. 2 of 2004 on Industrial Relations Dispute Settlement, has the authority to resolve disputes between workers and employers. Court decisions are expected to be accepted and implemented by the parties involved in the dispute.

Issues related to Industrial Court decisions include a lack of implementation. Often, despite the court issuing a clear decision, the on-the-ground execution does not align with it. This is due to various factors, including insufficient law enforcement or non-compliance by the losing party.

Oversight of the implementation of court decisions is frequently weak. Relevant agencies may lack the capacity or resources to ensure that decisions are properly executed. For example, in the case of PT. XYZ versus the Workers' Union, although the court ruled that the company must pay compensation to workers who were unlawfully terminated, the company did not implement the decision. This case illustrates a common problem in labor law enforcement.

To reduce discrepancies, there needs to be improved oversight and coordination between the court, labor departments, and other relevant agencies. Additionally, enhancing understanding of court decisions and legal obligations through socialization and education for employers and workers is crucial.

2. Solutions

Solutions for Enhancing Execution of Decisions:

a. Strengthening Law Enforcement

Substantive and Procedural Justice Principles in the Implementation of Industrial Court Decisions: Challenges and Solutions

To enforce the law effectively, it is necessary to apply sanctions or fines for parties that do not comply with court rulings to encourage timely execution. Alternative approaches can include mediation and conciliation to resolve disputes more quickly.

- 1) Enhancing Supervisory Capacity
Increase the capacity and authority of supervisors to address non-compliance with decisive actions.
- 2) Collaboration with Law Enforcement Authorities
Involve law enforcement authorities such as the police to assist in the execution of decisions that involve high levels of conflict or resistance.
- b. Simplifying Legal Processes
 - 1) Procedural Reform
Simplify legal procedures for executing decisions to make them more efficient and faster.
 - 2) Digitalization of Legal Processes
Implement digital systems to track and manage the execution of decisions, which can expedite the process.
- c. Education and Socialization
 - 1) Educational Programs for Employers and Workers
Enhance knowledge about their rights and obligations, as well as the impact of implementing court decisions.
 - 2) Socialization of Court Decisions
Socialize court decisions to relevant parties to ensure they understand and comply with the rulings.
- d. Alternative Dispute Resolution Mechanisms
 - 1) Mediation and Conciliation
Use mediation or conciliation to resolve disputes before executing decisions, which can reduce conflicts and speed up resolution.
 - 2) Utilization of Arbitration
Employ arbitration to handle disputes that cannot be resolved through traditional judicial processes.

V. CONCLUSIONS

1. Substantive Justice requires that Industrial Court rulings reflect a fair distribution of rights and obligations, such as providing compensation and restoring workers' rights if they are unlawfully terminated. The execution of decisions must align with this principle, ensuring that the rights recognized by the ruling are effectively implemented. On the other hand, Procedural Justice and the implementation of Industrial Court decisions are interconnected: procedural justice emphasizes a fair and transparent decision-making process, while the implementation of decisions focuses on applying the ruling fairly and effectively in practice.
2. Challenges in the implementation of Industrial Court decisions include delays in the execution process, resistance from employers against the implementation of rulings, and discrepancies between decisions and their on-the-ground execution. Solutions to improve the execution of decisions include: Strengthening Law Enforcement (Enhancing Supervisory Capacity and Collaboration with Law Enforcement Authorities), Simplifying Legal Processes (Procedural Reform and Digitalization of Legal Processes), Education and Socialization (Educational Programs for Employers and Workers and Socialization of Court Decisions), and Alternative Dispute Resolution Mechanisms (Mediation and Conciliation, and Utilization of Arbitration).

REFERENCES

- 1) Ningsih, S. (2022). *Prinsip Keadilan dalam Peradilan Ketenagakerjaan*. Jakarta: Penerbit Hukum Nusantara, 45.
- 2) Hadi, B. (2021). "Kompleksitas Kasus dalam Pengadilan Hubungan Industrial." *Jurnal Hukum dan Ketenagakerjaan*, 10(2), 126.
- 3) Rahmawati, L. (2020). *Akses Informasi dalam Penyelesaian Sengketa Ketenagakerjaan*. Bandung: Penerbit Adab, 58.
- 4) Siregar, R. (2023). "Transparansi dan Keadilan Prosedural dalam Pengadilan Hubungan Industrial." *Hukum dan Masyarakat*, 15(1), 48.
- 5) Arief, M. (2022). *Prosedur Peradilan Ketenagakerjaan: Tantangan dan Solusi*. Yogyakarta: Penerbit Keadilan, 77.
- 6) Putri, F. (2021). "Pengaruh Transparansi Proses Peradilan terhadap Keadilan Hukum." *Jurnal Hukum dan Politik*, 12(3), 205.
- 7) Santoso, A. (2020). "Ketidaksetaraan Akses dalam Sistem Peradilan Ketenagakerjaan." *Jurnal Kesejahteraan Sosial*, 8(2), 80.
- 8) Nugroho, W. (2023). *Pelatihan dan Pendidikan dalam Peradilan Ketenagakerjaan*. Jakarta: Penerbit Pusat Studi Hukum, 92.
- 9) Azizah, I. (2022). "Mekanisme Pengawasan Independen dalam Pengadilan Hubungan Industrial." *Jurnal Hukum dan Etika*, 11(2), 140.

Substantive and Procedural Justice Principles in the Implementation of Industrial Court Decisions: Challenges and Solutions

- 10) Maulana, F. (2021). *Sederhanakan Prosedur Hukum: Kunci Keadilan Prosedural*. Surabaya: Penerbit Keadilan Sejati, 102.
- 11) Rawls, J. (1971). *A theory of justice*. Harvard University Press, 60-75.
- 12) Sen, A. (2009). *The idea of justice*. Harvard University Press, 45-60.
- 13) Nussbaum, M. (2000). *Women and human development: The capabilities approach*. Cambridge University Press, 100-115.
- 14) Lind, E. A., & Tyler, T. R. (1988). *The social psychology of procedural justice*. Springer, 159-180.
- 15) Tyler, T. R. (2006). *Why people obey the law*. Princeton University Press, 80-90.
- 16) Thibaut, J. W., & Walker, L. (1975). *Procedural justice: A psychological analysis*. Erlbaum, 45-60.
- 17) "Administrative Delays in Judicial Execution" (2021). *Journal of Administrative Law*, 15(2), 34-36..
- 18) "Challenges in Enforcing Court Decisions" (2022). *Legal Studies Review*, 18(1), 15-18.
- 19) "Resource Constraints in Legal Enforcement" (2020). *International Journal of Law*, 22(4), 22-24.
- 20) "Economic Impact of Delayed Judgments on Workers" (2019). *Economic and Social Review*, 12(3), 45-47.
- 21) "Mental Health Implications of Delayed Legal Processes" (2023). *Psychology and Law Journal*, 8(2), 78-80.
- 22) "Impact of Delayed Execution on Corporate Reputation" (2021). *Business Ethics Quarterly*, 20(1), 11-14.
- 23) "Additional Costs of Delayed Legal Compliance" (2022). *Journal of Business Law*, 25(3), 56-59.
- 24) "Public Trust and Legal Delay" (2022). *Public Administration Review*, 45(1), 90-92.
- 25) "Efficiency Issues in Legal Systems" (2021). *Law and Policy Review*, 30(2), 65-68.
- 26) "Procedural Complexity and Legal Delays." (2020). *Legal Procedure Journal*, 17(4), 33-35.
- 27) "Court Administration and Delayed Justice." (2022). *Judicial Review Quarterly*, 19(3), 12-15.
- 28) "Legal Tactics to Delay Judgment Execution." (2023). *Law and Society Journal*, 24(2), 58-61.
- 29) "Cooperation Issues in Judgment Execution." (2021). *Conflict Resolution Quarterly*, 13(1), 21-23.
- 30) "Resource Limitations in Legal Execution." (2020). *Legal Economics Review*, 21(3), 76-78.
- 31) "External Factors Affecting Judicial Execution." (2022). *Global Legal Studies Journal*, 12(4), 89-91.
- 32) "Administrative Delays in Judicial Execution" (2021). *Journal of Administrative Law*, 15(2), 37-40.
- 33) "Challenges in Enforcing Court Decisions" (2022). *Legal Studies Review*, 18(1), 15-18.
- 34) "Resource Constraints in Legal Enforcement" (2020). *International Journal of Law*, 22(4), 22-24.
- 35) Rahardjo, M. D. (2018). Penerapan dan penegakan hukum ketenagakerjaan di Indonesia. *Jurnal Hukum dan Pembangunan*, 48(2), 123-139.
- 36) Santoso, A. (2019). Kendala pengawasan dan penegakan hukum dalam penyelesaian sengketa hubungan industrial. *Jurnal Administrasi Publik*, 10(1), 45-58.
- 37) Prasetyo, E. (2020). Analisis kasus PT. XYZ dan implementasi putusan pengadilan hubungan industrial. *Jurnal Hukum Ketenagakerjaan*, 15(3), 75-90.
- 38) Ridwan, S. H. (2021). Strategi pengawasan dan penegakan hukum dalam penyelesaian sengketa hubungan industrial. *Jurnal Kebijakan Publik*, 22(4), 200-215.
- 39) Budiono, F. S. (2022). Peran edukasi dalam implementasi putusan pengadilan hubungan industrial. *Jurnal Pendidikan Hukum*, 19(1), 112-126.
- 40) Sanctions for non-compliance in court orders. (2021). *Law Enforcement Review*, 18(2), 52-54.
- 41) Widodo, T. (2023). Penguatan penegakan hukum dalam eksekusi putusan pengadilan. *Jurnal Penegakan Hukum*, 22(1), 25-40.
- 42) Prabowo, H. (2022). Kolaborasi antara lembaga dalam eksekusi putusan pengadilan. *Jurnal Kebijakan Hukum*, 20(3), 112-130.
- 43) Santoso, E. (2021). Reformasi prosedur hukum dalam eksekusi putusan. *Jurnal Hukum dan Prosedur*, 18(2), 65-80.
- 44) Alif, R. (2023). Digitalisasi dalam administrasi eksekusi putusan pengadilan. *Jurnal Teknologi Hukum*, 7(1), 45-60.
- 45) Sari, D. P. (2022). Program edukasi untuk meningkatkan kesadaran hukum. *Jurnal Pendidikan Hukum*, 19(1), 90-105.
- 46) Rizal, M. (2022). Sosialisasi dan implementasi putusan pengadilan hubungan industrial. *Jurnal Sosial dan Ketenagakerjaan*, 17(2), 75-90.
- 47) Amalia, N. (2021). Peran mediasi dalam penyelesaian sengketa ketenagakerjaan. *Jurnal Hubungan Industrial*, 15(2), 85-100.
- 48) Hadi, M. (2022). Arbitrase sebagai alternatif penyelesaian sengketa hubungan industrial. *Jurnal Arbitrase dan Ketenagakerjaan*, 13(1), 30-45.



There is an Open Access article, distributed under the term of the Creative Commons Attribution – Non Commercial 4.0 International (CC BY-NC 4.0) (<https://creativecommons.org/licenses/by-nc/4.0/>), which permits remixing, adapting and building upon the work for non-commercial use, provided the original work is properly cited.

Smart Strategies in the Digital Age: Conventional Retail Facing the Revolution E-Commerce



Chris Partogi¹, Mochamad Heru Riza Chakim², Mulyati³

^{1,2,3} Department of Retail Management, Faculty of Economics and Business, Raharja University

ABSTRACT: The aim of this research is to see how e-commerce trends impact traditional retail marketing strategies. The study emphasize the use of new technologies such as augmented reality (AR), artificial intelligence (AI), and omnichannel approaches as a way to maintain traditional retail competitiveness. This was done using the PRISMA framework and SWOT analysis. Data was collected from eleven relevant articles over the past three years (2022-2024) using searches in ScienceDirect and Google Scholar. Results show that the use of technology in omnichannel strategies can improve customer experience and operational efficiency. However, the main obstacles remain infrastructure limitations, high investment costs and data security threats. To address this issue, it is recommended to use mitigation strategies that prioritize technology partnerships and focus on specific market segments. This research provides practical guidelines for retail partitioners to adjust to the dynamics of the e-commerce market. In addition, this research offers a perspective for academics in studying retail transformation in the digital era.

KEYWORDS: e-commerce, omnichannel, marketing strategy, conventional retail, SWOT analysis

I. INTRODUCTION

Rapid advances in information and communication technology have changed the business sector in the world in recent years. The digital economy is characterized by transforming the economy, jobs and even society as a whole by introducing new technologies and digital processes that have contributed crucially to economic development. The digital economy involves transactions resulting from countless online connections between data, machines, companies, and people (Soava, Mehedintu, & Sterpu, 2022). One of the most striking changes includes the rapid growth of e-commerce which has presented several major challenges for conventional retail. As stated by Merzlyakova et al., (2021) that the world e-commerce market in 2019 has grown rapidly by \$3.4 trillion in 2019, and will be expected to continue to increase every year.

Agyeman et al., (2022) in his studies evaluate performance and adoption *e-commerce* of the world's leading companies such as Amazon, JD.com, Alibaba, and Sunning.com, the four companies indicated that *e-commerce* will continue to experience significant growth of 22% in 2023 until 2040 continues to increase, and can provide advice to governments and organizations in expanding technology *e-commerce* in areas such as automatic delivery, *telemedicine*, education, and *streaming* direct. In addition, information technology regarding progress in *AI*, *AR/VR*, and big data analysis allows *e-commerce* to provide an increasingly personalized and efficient shopping experience, thereby challenging the dominance of traditional physical stores (S. Li, Liu, Su, Luo, & Yang, 2023; Nauriy et al., 2024).

This rapid growth has encouraged conventional retailers to reevaluate their marketing plans in order to maintain competitiveness in a market world that is increasingly moving towards the digital era. Studies conducted by Dumanska et al., (2021) explained that attendance at shopping centers decreased by 20%-45% and purchases were regular *online* experienced an increase of up to 41%, which has crucially influenced changes in trade internationally. Charm et al., (2020) explained that consumers in various countries have moved to shop *offline* to shop *online* for approximately 60%. Another example is in business *e-commerce* the TikTok media platform is experiencing significant changes, especially in Southeast Asia and China 4.4 billion US dollars or the equivalent of IDR 76.6 trillion in 2022 (Meliala, 2024).

The changes have prompted conventional retail to immediately push *omnichannel* which integrates the shopping experience *online* and *offline*. This encourages retailers not to focus too much on physical stores, but to continue to develop a strong digital presence to meet increasingly changing consumer expectations. So, growth *e-commerce* what has happened has created new

Smart Strategies in the Digital Age: Conventional Retail Facing the Revolution E-Commerce

habits regarding consumer spending habits and can shape the future of the retail industry (Ratchford, Soysal, Zentner, & Gauri, 2022). Rapid growth e-commerce, does not eliminate the important role of conventional retail in the shopping ecosystem. Lindiawatie et al., (2024) explain purchases regularly *online* has several risks, making some people still choose to shop online *offline* or come directly to the shop. By shopping directly in the store, the purchase of certain products can be seen directly by consumers and products that require touch can be felt directly by consumers rather than when shopping *online*.

Move to *e-commerce* have a significant impact on employment opportunities in the retail sector. Research conducted by Shankar et al., (2021) projecting significant changes in the required skills and occupational structure in the retail sector. Changes in skills are expected to continue to increase by 50% until 2025 (L. Li, 2022). Subsequently, changes in the conventional retail sector have had an impact on the vitality of urban centres and the use of urban space, requiring responsive strategic planning (Talen & Park, 2021). Therefore, a deep understanding of such dynamics is important to design strategically and effectively.

To remain relevant, Therefore, a deep understanding of such dynamics is important to design strategically and effectively (Ramadhan et al., 2024). Therefore, understanding the impact of *e-trendscommerce* conventional retail marketing strategies are very important for the sustainability and success of retail businesses in today's digital era. So that the information provided can increase insight and inspiration for future practitioners and academics. Then the incorporation of PRISMA methods and SWOT analysis provides a systematic and comprehensive framework for writing. The PRISMA method provides a valid and relevant data source, and SWOT analysis provides strategic insight as a foundation for providing practical recommendations for conventional retail adaptation to trends *e-commerce*.

II. METHODOLOGY

A. Search Strategy

This research uses the ScienceDirect and Google Scholar databases as material for searching for the necessary data, and searches start from using the ScienceDirect database and then Google Scholar which is cleared as one of the indexing systems for citations. These two sources are the most frequently visited by researchers in various worlds. Search strategies include a combination of keyword variations ("*e-commerce influence*" OR "*retail marketing strategy*" OR "*e-commerce trend*" OR "*conventional retail marketing*" OR "*retail transformation*"). The searches carried out follow the guidelines *Preferred Reporting Items for Systematic Reviews and Meta-Analyses (PRISMA)* which emphasizes the importance of review reports that evaluate randomized trials and are used as a basis for reporting systematic reviews in various other types of research (Permatasari, Hutabarat, & Purnamasari, 2023).

B. Inclusion Criteria

The inclusion criteria used in this research include: (1) Articles used in English, (2) Articles published in the last 3 years, namely 2022-2024, (3) Articles that are explicitly offensive *e-commerce* in conventional retail in the goods sector.

C. Procedure

The initial data obtained amounted to The 11,126 publications from the identification made through the search of the ScienceDirect database totaled 4,266 articles and Google Scholar 6,900 articles. After following the exceptions in the predetermined criteria, 11 articles remain (Bonfanti, Vigolo, Vannucci, & Brunetti, 2023; Kulkarni & Khan, 2023; Merritt & Zhao, 2022; Ranjan, 2024; Sadhya, 2024; Salah & Ayyash, 2024; Suh & Moradi, 2023; Vhatkar et al., 2024; Wang, 2023; Yang, Liu, Cao, Sun, & Kong, 2024; Yin, Chiu, Hsieh, & Kuo, 2022). Most of the articles are not used because they are not offensive *e-commerce* in conventional retail. All articles are extracted from sources and analyzed through Mendeley software to help remove duplicate articles. This explanation can be seen in figure 1.

Smart Strategies in the Digital Age: Conventional Retail Facing the Revolution E-Commerce

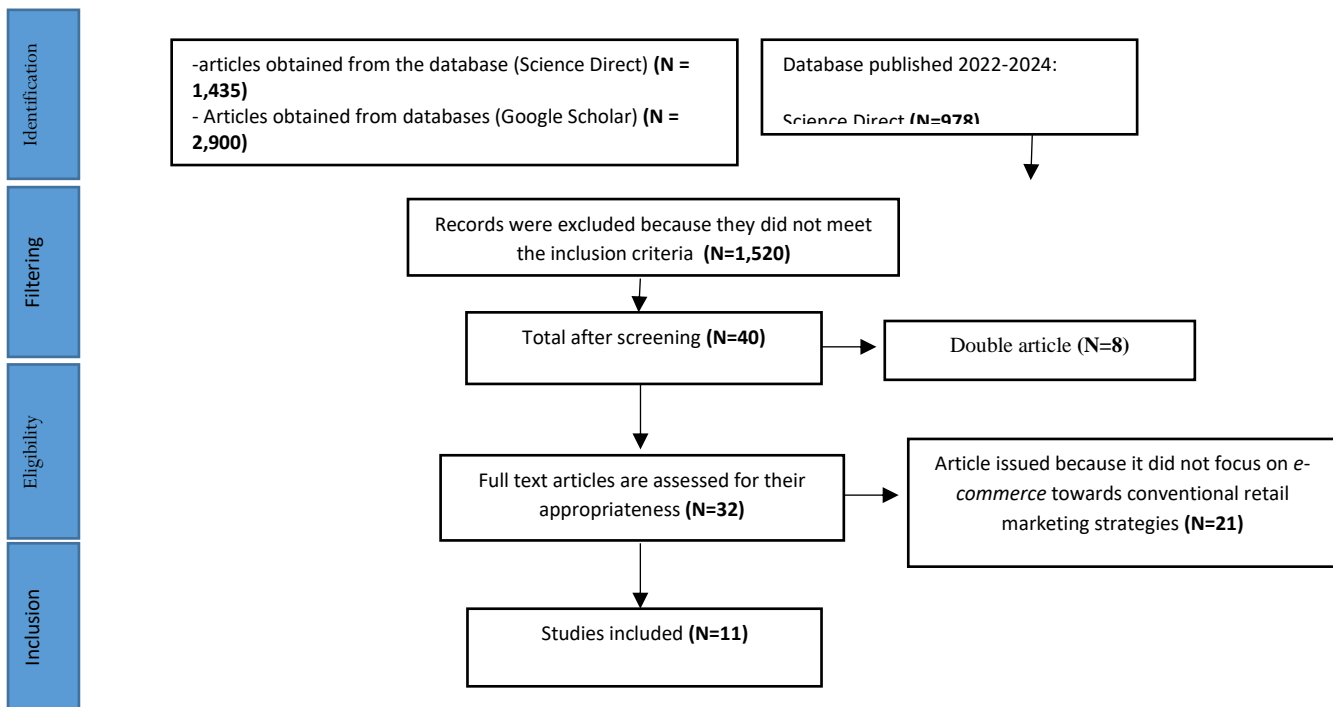

Figure 1. Prisma Research Flowchart

D. Analysis Methods

The analytical method to be used in this study was SWOT, which was then elaborated using a qualitative descriptive approach to construct the SWOT matrix.

III. RESULTS AND DISCUSSION

A. Results

The results of the application of the SWOT analysis that has been carried out are then presented through elaboration with a qualitative descriptive approach to produce a SWOT matrix. The following will explain the overall SWOT analysis from the data sources that have been obtained in the following table:

Table 1. SWOT Analysis

<i>Strengths</i> (Strength)	Digitalization and Technology: <ul style="list-style-type: none"> - Adoption of innovative technologies includes <i>AI</i>, <i>AR/VR</i>, <i>Chatbots</i>. - Integration <i>omnichannel</i> effective. - Data-driven personalization system. - <i>Live streaming platform</i> interactive. Operations and Efficiency: <ul style="list-style-type: none"> - Increase in business productivity. - Operational cost efficiency. - Flexibility in pricing and promotion strategies. - Wider market reach.
<i>Weaknesses</i> (Weakness)	Implementation and Infrastructure: <ul style="list-style-type: none"> - Limitations of technological infrastructure. - High investment costs for digitalization. - Difficulty in maintaining consistency between channels. Adaptation and Experience: <ul style="list-style-type: none"> - Limitations of physical experience in <i>e-commerce</i>. - Variations in digital availability between business actors. - Lack of direct consumer perspective.

Smart Strategies in the Digital Age: Conventional Retail Facing the Revolution E-Commerce

<i>Opportunities (Opportunity)</i>	<p>Expansion and Innovation:</p> <ul style="list-style-type: none"> - Market growth <i>e-commerce</i> global. - Sustainable technology development. - Experience integration <i>phygital (physical-digital)</i>. <p>Customer Experience:</p> <ul style="list-style-type: none"> - Personalize data-driven services. - Increased interactivity through <i>live streaming</i>. - Collaboration with <i>influencers</i> social media.
<i>Threats(Threat)</i>	<p>Competition and Market:</p> <ul style="list-style-type: none"> - Competition from <i>e-commerce platform</i> big. - Changing consumer preferences to digital. - Decline in physical store traffic. <p>Risks and Challenges:</p> <ul style="list-style-type: none"> - Data security and privacy. - Dependence on technology partners. - Socio-economic impact on traditional retailing.

After knowing the results of each section *Strengths, Weaknesses, Opportunities, Threats*, will be entered into the table *matrix* SWOT to see the strategy *SO (Strengths-Opportunities), WO (Weaknesses-Opportunities), ST (Strengths-Threats), and WT (Weaknesses-Threats)* which can be implemented. The following is a table of results from *matrix* SWOT:

Table 2. SWOT Matrix

Internal/External	<i>Strengths (S)</i>	<i>Weaknesses (W)</i>
	<ol style="list-style-type: none"> 1. Adoption of innovative technologies 2. Integration <i>omnichannel</i> effective 3. Data personalization system 4. <i>Live streaming platform</i> 5. Operational efficiency 	<ol style="list-style-type: none"> 1. Infrastructure limitations 2. High investment costs 3. Difficulty in channel consistency 4. Limitations of physical experience 5. Variations in digital willingness
<i>Opportunities (O)</i>	<p>Strategy <i>Strengths-Opportunities</i></p> <ol style="list-style-type: none"> 1. <i>Omnichannel platform</i> integrated 2. Data personalization program 3. Optimize live streaming 4. Cross-channel loyalty program 5. Integration <i>influencer marketing</i> 	<p>Strategy <i>Weaknesses-Opportunities</i></p> <ol style="list-style-type: none"> 1. Gradual technology implementation 2. Technology provider partnerships 3. Consistent service standards 4. Research on consumer experience 5. Digital education via <i>influencers</i>
<i>Threats (T)</i>	<p>Strategy <i>Strengths-Threats</i></p> <ol style="list-style-type: none"> 1. Integrated differentiation of experience 2. Consumer trend prediction 3. Digital integration in physical stores 4. Powerful data security system 5. Internal technology capabilities 	<p>Strategy <i>Weaknesses-Threats</i></p> <ol style="list-style-type: none"> 1. Specific market segment focus 2. Strategy partnership 3. Operational efficiency 4. Hr Training 5. <i>Contingency plan</i> Techno

B. DISCUSSION

Strategy Analysis Weaknesses-Opportunities

Addressing internal weaknesses through exploiting external opportunities through gradual adoption of technology is the goal of the WO strategy. In this case, companies can implement technology gradually to reduce the risks that may arise from technology adoption too quickly. Several previous studies provided solutions to address internal weaknesses, such as focusing on customer experience, collaboration with third parties, adoption of new technologies, listening to and implementing customer feedback, product and service innovation, integrated marketing, employee skills development, and adaptation to market changes (Barykin et al., 2022; Ngamvichaikit, 2024; Sun & Jung, 2024; Zangana et al., 2024). It aims to ensure that any innovation is implemented effectively and generates additional value for business operations, essential to provide an initial focus on the most important technologies. Thus, assessing the effectiveness of technology implementation, companies must carry out regular evaluations. Further, working with technology providers allows for increased investment costs through knowledge transfer and resource sharing. Apart from that, by establishing partnerships with technology providers, e-commerce platforms or logistics companies, we can strengthen today's omnichannel infrastructure (Barykin et al., 2022). Thus, it allows companies to widen their reach and increase operational efficiency (Zangana et al., 2024). This allows internal capabilities to develop more efficiently and optimally.

Strategy Analysis Strengths-Threats

Strategy strengths-threats in digital retail encourage companies to use power internally to address risks externally, one of which is by providing a different experience for consumers. What companies can do is by utilizing technological integration to create a unique proportion of value. By creating new products and services that can meet the needs of a frequently changing market (Barykin et al., 2022). Companies can carry out new innovations to reduce the risk of losing market share due to competition or changes in consumer preferences and help companies remain relevant (Gasparin & Slongo, 2023; Sun & Jung, 2024; Zangana et al., 2024). A focus on experience for excellent consumers provides a competitive advantage in attracting and retaining consumers. Meanwhile, attention to data security is very important considering the increasing and increasingly complex cyber threats. As explained by Zangana et al., (2024) to minimize external risks companies can exploit strengthening technology infrastructure, resulting from cyber threats or disruptions in the supply chain. So, companies can implement stricter security systems by focusing on protecting consumer data, including audits and system updates which are carried out periodically in order to maintain consumer integrity and trust in the digital retail platform used. In addition, the use of new technologies adopted by a company can improve data analysis and decision making. This means that companies can better understand market trends and customer behavior so they can respond more effectively (Barykin et al., 2022).

Strategy Analysis Weaknesses-Threats

The weaknesses-threats strategy focuses on a defense approach in reducing weaknesses and preventing threats. By focusing on specific market segments to find and serve more exclusive market segments. This is in line with the statement Zangana et al., (2024) correlates with *stakeholders*, as customers, suppliers and business partners can build stronger relationships useful to help companies overcome any external threats. Additionally, by optimizing resources on specific parts of the market, companies can form stronger correlations in consumers and cultivate specialized skills that suit the needs of those segments. Through training and skills development can help companies be better prepared to face external risks (Ngamvichaikit, 2024). So that the company is ready to face challenges that arise, such as changes in regulations or market fluctuations (Sun & Jung, 2024). Meanwhile, the weaknesses-threats strategy prioritizes operational efficiency so that companies can reduce operational costs by maximizing business processes. Increasing efficiency and reducing dependence on manual labor regarding some business functions can implement automation. Therefore, companies can still run optimally amidst dynamic market challenges thanks to more precise processes resulting from the use of lean management systems. As is Ngamvichaikit, (2024) reports that companies must have mitigation strategies, this aims to improve employee training, investment in new technology, or improve operational processes to increase efficiency and effectiveness.

IV. CONCLUSIONS

This study shows how important it is to change conventional retail marketing strategies to face the rapid growth of e-commerce in the digital era. Artificial intelligence (AI), augmented reality (AR), and omnichannel can be the main forces for increasing competitiveness, according to SWOT conducted. Huge opportunities are also emerging from the global e-commerce market, allowing businesses to improve customer service and shopping experiences.

However, problems such as limited infrastructure and high investment costs must be addressed by gradually implementing technology and cooperating strategically with technology providers. Effective mitigation approaches are needed to reduce threats

Smart Strategies in the Digital Age: Conventional Retail Facing the Revolution E-Commerce

from outside sources, such as increased competition from large e-commerce platforms and data security risks. This approach includes strengthening security systems and concentrating on specific market segments.

Thus, this research provides practical guidance for retail industry players to adapt to e-commerce trends while maintaining their competitive advantage, as omnichannel strategies prove to be relevant steps to integrate online and offline shopping experiences, increase consumer satisfaction, and support the sustainability of conventional retail businesses.

V. IMPLICATIONS

This research has benefits for both parties, practitioners and academics. Practitioners can use the SWOT framework to create effective marketing strategies, and academics can use these findings as a basis for conducting further research on how technology impacts conventional retail.

VI. RESEARCH LIMITATIONS

This study only uses data from articles published in the last three years (2022-2024), so it does not cover a wider history. In addition, the focus of the study is on goods retailing, so the results may not be fully applicable to the services sector.

REFERENCES

- 1) Agyeman, F. O., Zhiqiang, M. A., Li, M., Sampene, K., Frimpong, M., & Brenya, R. (2022). Comprehending the Globalization and Performance of E-Commerce Businesses: Evidence From E-Commerce Companies. *Original Research Article Asian Journal of Advances in Research*, 5(1), 409–424. Retrieved from <http://research.sdpublishers.net/id/eprint/3279/>
- 2) Bonfanti, A., Vigolo, V., Vannucci, V., & Brunetti, F. (2023). Creating memorable shopping experiences to meet phygital customers' needs: evidence from sporting goods stores. *International Journal of Retail and Distribution Management*, 51(13), 81–100. <https://doi.org/10.1108/IJRDM-12-2021-0588>
- 3) Charm, T., Coggins, B., Robinson, K., & Wilkie, J. (2020). The great consumer shift: Ten charts that show how US shopping behavior is changing.
- 4) Dumanska, I., Hrytsyna, L., Kharun, O., & Matviets, O. (2021). E-commerce and M-commerce as Global Trends of International Trade Caused by the Covid-19 Pandemic. *WSEAS TRANSACTIONS ON ENVIRONMENT AND DEVELOPMENT*, 17, 386–397. <https://doi.org/10.37394/232015.2021.17.38>
- 5) Kulkarni, M. M., & Khan, Z. (2023). The Evolution and Impact of E-Commerce on Malls in India: a Comparative Analysis. *EPRA International Journal of Economic and Business Review*, (May 2023), 24–29. <https://doi.org/10.36713/epra13456>
- 6) Li, L. (2022). Reskilling and Upskilling the Future-ready Workforce for Industry 4.0 and Beyond. *Information Systems Frontiers*. <https://doi.org/10.1007/s10796-022-10308-y>
- 7) Li, S., Liu, Y., Su, J., Luo, X., & Yang, X. (2023). Can e-commerce platforms build the resilience of brick-and-mortar businesses to the COVID-19 shock? An empirical analysis in the Chinese retail industry. *Electronic Commerce Research*, 23(4), 2827–2857. <https://doi.org/10.1007/s10660-022-09563-7>
- 8) Lindiatie, Dhona Shahreza, & Lisna Wati. (2024). Analisis Perbandingan Penjualan Offline Dan Online Produk Fashion Meccanism Sebagai Cara Menarik Konsumen. *Jurnal Manajemen Dan Ekonomi Bisnis*, 4(1), 334. Retrieved from <https://prin.or.id/index.php/cemerlang/article/view/2574/2355>
- 9) Meliala, R. A. S. (2024). *Dampak Saluran Integrasi terhadap Loyalitas Melalui Pengalaman Berbelanja Generasi Z di Aplikasi Tiktok pada Kota Medan* (Universitas HKBP Nonmensen Medan). Universitas HKBP Nonmensen Medan. Retrieved from [https://repository.uhn.ac.id/bitstream/handle/123456789/10287/ROBI ANDIKA SEMBIRING MELIALA.pdf?sequence=1&isAllowed=y](https://repository.uhn.ac.id/bitstream/handle/123456789/10287/ROBI%20ANDIKA%20SEMBIRING%20MELIALA.pdf?sequence=1&isAllowed=y)
- 10) Merritt, K., & Zhao, S. (2022). The Power of Live Stream Commerce: A Case Study of How Live Stream Commerce Can Be Utilised in the Traditional British Retailing Sector. *Journal of Open Innovation: Technology, Market, and Complexity*, 8(2), 71. <https://doi.org/https://doi.org/10.3390/joitmc8020071>
- 11) Merzlyakova, E., Ershova, I., & Bridskiy, E. (2021). Main Trends in the Development of the Global E-Commerce Market. *SHS Web Conf.*, 110. Retrieved from <https://doi.org/10.1051/shsconf/202111001035>
- 12) Nauriy, C., Santosa, E. B., Hastomo, M. D., Pantjarani, A., Purbiyanto, E., Santosa, T. B., ... Alawiyah, L. (2024). *Literasi Digital dan Peningkatan Daya Saing UMKM Masa Kini (Pertama)*. Surakarta: Politeknik Harapan Bangsa Surakarta.
- 13) Permatasari, I., Hutabarat, P. M., & Purnamasari, E. (2023). Faktor Evaluasi Usabilitas dalam Sistem e-learning dengan Panduan Tinjauan Sistematis PRISMA: Indonesia. *J-ENSITEC (Journal of Engineering and Sustainable Technology)*, 9(02 SE-Articles), 805–810. <https://doi.org/10.31949/jensitec.v9i02.3662>
- 14) Ramadhan, B., Maâ€™ruf, F. N., Darmawan, F., Santoso, K. A., Mitasari, Maulana, A., & Hananto, D. (2024). Inovasi

Smart Strategies in the Digital Age: Conventional Retail Facing the Revolution E-Commerce

Pemasaran Jasa : Meningkatkan Daya Saing Bisnis di Era Digital. *Philosophiamundi*, 1(2 SE-Articles). Retrieved from <https://philosophiamundi.id/index.php/philosophia/article/view/29>

- 15) Ranjan, S. (2024). The impact of e-commerce on traditional retail model in India. *Interantional Journal of Scientific Research in Engineering and Management*, 08(04), 1–5. <https://doi.org/10.55041/ijrsrem32677>
- 16) Ratchford, B., Soysal, G., Zentner, A., & Gauri, D. K. (2022). Online and offline retailing: What we know and directions for future research. *Journal of Retailing*, 98(1), 152–177. <https://doi.org/https://doi.org/10.1016/j.jretai.2022.02.007>
- 17) Sadhya, P. (2024). Impact of E-Commerce on Traditional Retailers of Electronic and Garments. *Interantional Journal of Scientific Research in Engineering and Management*, 08(04), 1–5. <https://doi.org/10.55041/ijrsrem31019>
- 18) Salah, O. H., & Ayyash, M. M. (2024). E-commerce adoption by SMEs and its effect on marketing performance: An extended of TOE framework with ai integration, innovation culture, and customer tech-savviness. *Journal of Open Innovation: Technology, Market, and Complexity*, 10(1), 100183. <https://doi.org/https://doi.org/10.1016/j.joitmc.2023.100183>
- 19) Shankar, V., Kalyanam, K., Setia, P., Golmohammadi, A., Tirunillai, S., Douglass, T., ... Waddoups, R. (2021). How Technology is Changing Retail. *Journal of Retailing*, 97(1), 13–27. <https://doi.org/https://doi.org/10.1016/j.jretai.2020.10.006>
- 20) Soava, G., Mehedintu, A., & Sterpu, M. (2022). Analysis and Forecast of the Use of E-Commerce in Enterprises of the European Union States. *Sustainability*, Vol. 14. <https://doi.org/10.3390/su14148943>
- 21) Suh, T., & Moradi, M. (2023). Transferring in-store experience to online: An omnichannel strategy for DIY customers' enhanced brand resonance and co-creative actions. *Journal of Business Research*, 168(February 2022), 114237. <https://doi.org/10.1016/j.jbusres.2023.114237>
- 22) Talen, E., & Park, J. (2021). Understanding Urban Retail Vacancy. *Urban Affairs Review*, 58(5), 1411–1437. <https://doi.org/10.1177/10780874211025451>
- 23) Vhatkar, M. S., Raut, R. D., Gokhale, R., Kumar, M., Akarte, M., & Ghoshal, S. (2024). Leveraging digital technology in retailing business: Unboxing synergy between omnichannel retail adoption and sustainable retail performance. *Journal of Retailing and Consumer Services*, 81, 104047. <https://doi.org/https://doi.org/10.1016/j.jretconser.2024.104047>
- 24) Wang, T. (2023). Research on the Impact of E-commerce on Offline Retail Industry. *Frontiers in Business, Economics and Management*, 10(1), 169–173. <https://doi.org/10.54097/fbem.v10i1.10237>
- 25) Yang, R., Liu, J., Cao, S., Sun, W., & Kong, F. (2024). Impacts of agri-food e-commerce on traditional wholesale industry: Evidence from China. *Journal of Integrative Agriculture*, 23(4), 1409–1428. <https://doi.org/10.1016/j.jia.2023.10.020>
- 26) Yin, C. C., Chiu, H. C., Hsieh, Y. C., & Kuo, C. Y. (2022). How to retain customers in omnichannel retailing: Considering the roles of brand experience and purchase behavior. *Journal of Retailing and Consumer Services*, 69(February), 103070. <https://doi.org/10.1016/j.jretconser.2022.103070>

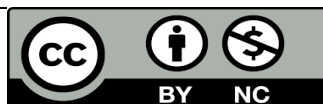

There is an Open Access article, distributed under the term of the Creative Commons Attribution – Non Commercial 4.0 International (CC BY-NC 4.0)

(<https://creativecommons.org/licenses/by-nc/4.0/>), which permits remixing, adapting and building upon the work for non-commercial use, provided the original work is properly cited.

The Importance of Digital Literacy in Enhancing the Quality of Education and Social Harmony



Willy Bachtiar¹, Wahyu Budi Priatna², Hudi Santoso³, Abung Supama Wijaya⁴,
David Rizar Nugroho⁵

^{1,2,3,4,5} Digital and Media Communication, College of Vocational Studies, IPB University, Bogor, Indonesia

ABSTRACT: Digital literacy has become a crucial aspect in the development of modern education in the digital era. Students' ability to access, understand, and use digital technology directly contributes to both the quality of education and social harmony. This research aims to understand the extent to which digital literacy has been adopted by students in schools and how these skills impact their educational quality and social interactions. This article explores the importance of digital literacy in improving education quality and fostering social cohesion through a survey conducted among students at SMA Negeri 3 Sumedang. The research aims to examine the relationship between digital literacy and its impact on education quality and social harmony. Data were collected from 272 students as respondents. The findings indicate that increasing digital literacy has a positive correlation with improved education quality and the ability to engage in harmonious social interactions. The results of this research provide a foundation for developing educational programs that focus on enhancing digital skills and security awareness to prepare students for the challenges of the digital era.

KEYWORDS: Digital Literacy, Digital Technology, Social Harmony, Students, Quality Education

I. INTRODUCTION

In the era of the 4.0 Industrial Revolution and rapid digital transformation, digital literacy has become an essential competency that cannot be overlooked, particularly in the context of education and society. Digital literacy encompasses an individual's ability to access, understand, and use information through various digital platforms. This is important not only for supporting the learning process in schools but also for fostering more harmonious social interactions in society.

Digital literacy refers to the ability of individuals to use digital technology, communication, and media to access, manage, integrate, evaluate, and create information effectively, ethically, and safely. It involves the use of digital devices such as computers, smartphones, the internet, and social media, as well as the ability to critically and creatively process information. UNESCO (2018) defines digital literacy as a skill that is not limited to technical understanding but also includes the ability to think critically about the available digital information.

According to Gilster (1997), who first popularized this concept, digital literacy is the ability to understand and use information in various formats delivered through computers. In the modern context, digital literacy also involves the ability to interact effectively in online environments, understand the social and ethical implications of digital actions, and maintain cybersecurity. In the educational context, this ability plays a crucial role in enhancing the quality of teaching and learning processes, aligning with the paradigm shift in education in the digital era.

Recent research by Livingstone (2020) shows that strong digital literacy among students enables them to be more adept at utilizing digital resources for learning, ultimately contributing to better academic outcomes. Additionally, digital literacy contributes to the development of critical and collaborative thinking skills, which are essential for facing future challenges in the workforce and global society.

Besides its contribution to education, digital literacy also plays a vital role in promoting social harmony amid the overwhelming flow of information on social media and digital platforms. The presence of digital technology has changed the way individuals interact with each other, with social media becoming a new public space that often creates challenges related to ethics and social norms. Research by Boyd and Ellison (2007) shows that with the increasing use of social media, understanding digital ethics, such as how to interact positively and avoid conflicts in the online world, becomes crucial for maintaining social harmony.

The Importance of Digital Literacy in Enhancing the Quality of Education and Social Harmony

However, not all students in Indonesia possess adequate levels of digital literacy, especially in regions where access to technology is still limited. A study by Zainal (2021) in several secondary schools in Indonesia indicates that although the use of digital technology among students is increasing, there remains a significant gap in digital literacy. This is due to various factors, including limited infrastructure, low teacher skills in using digital technology, and a lack of awareness of the importance of digital literacy in building healthy social relationships.

On the other hand, a survey conducted by the Ministry of Education and Culture of Indonesia (2022) found that students with better digital literacy tend to have better communication skills, both inside and outside the school environment. They are more capable of avoiding digital conflicts, such as cyberbullying, and better understand the importance of ethics in online communication, which ultimately helps create a more harmonious social environment.

This research offers novelty by holistically examining how digital literacy affects not only academic aspects but also the social aspects of students, particularly in shaping social harmony in the digital era. The focus on the relationship between digital literacy and social interaction among high school students is an approach that has not been extensively researched in Indonesia.

This study has several main objectives, including: 1) to assess the level of digital literacy among students at SMA Negeri 3 Sumedang; 2) to analyze the relationship between digital literacy and the quality of education for students; 3) to identify the impact of digital literacy on social harmony among students; and 4) to provide recommendations for enhancing digital literacy to support quality education and social harmony.

Considering this background, the research focuses on the role of digital literacy in improving the quality of education and maintaining social harmony among students at SMA Negeri 3 Sumedang. The choice of SMA Negeri 3 Sumedang as the research location is based on the high use of digital technology in this school, as well as the school's interest in integrating digital technology into their learning curriculum.

II. RESEARCH METHODS

A. Type of Research

The type of research used is descriptive quantitative research. This research aims to explain and analyze the relationship between digital literacy, the quality of education, and social harmony among students. Quantitative research will produce numerical data that can be statistically analyzed, allowing researchers to describe and understand the phenomena under study more clearly. In this context, a survey will be used to collect information from 272 respondents representing the student population.

B. Research Approach

The approach used in this research is a cross-sectional approach. This approach allows for data collection at a specific point in time, enabling the researcher to explore the relationships between digital literacy, the quality of education, and social harmony within the student population. With this approach, the researcher can obtain a more comprehensive picture of students' perceptions of digital literacy and its impact on the quality of education and social interactions.

C. Data Collection Techniques

The data collection technique used is a survey using a questionnaire. The questionnaire will be designed with questions covering:

- a) Digital Literacy: Questions that measure students' abilities to use digital technology, search for information online, and communicate on digital platforms. Example questions:
 - i. How often do you use the internet to search for learning information?
 - ii. Do you feel skilled enough in using digital learning applications?
- b) Quality of Education: Questions that evaluate students' learning experiences, including their engagement in the learning process, access to digital learning resources, and the effectiveness of teaching. Example questions:
 - i. How do you assess the quality of teaching you receive at school?
 - ii. How important is the use of digital media in your learning?
- c) Social Harmony: Questions that assess students' social interactions both inside and outside the school environment, as well as the influence of digital literacy on friendships. Example questions:
 - i. How good are your relationships with your friends at school?
 - ii. Does social media help you interact better with your friends?

The questionnaire will be distributed online and also in paper form, depending on the conditions and preferences of the school, to reach all 272 respondents.

The Importance of Digital Literacy in Enhancing the Quality of Education and Social Harmony

D. Unit of Analysis / Research Subjects

The unit of analysis in this research is the students of SMA Negeri 3 Sumedang. The research will involve 272 students from various classes and majors to ensure data diversity. Respondents will be selected using random sampling techniques to minimize bias and ensure a good representation of the population. With a sample size of 272 respondents, this research is expected to provide valid and reliable results.

E. Data Analysis Techniques

The data collected from the survey will be analyzed using descriptive and inferential statistical techniques. The following are the steps of data analysis:

- a) **Descriptive Statistics:** Data will be summarized using descriptive statistics such as frequency, percentage, mean, and standard deviation. This will provide an overview of the levels of digital literacy, the quality of education, and social harmony among students. For example, the researcher can calculate the average score of digital literacy and describe the proportion of students who are satisfied with the quality of education.
- b) **Correlation Analysis:** The researcher will conduct correlation analysis, such as the Pearson correlation coefficient, to evaluate the relationships between the variables of digital literacy, the quality of education, and social harmony. This analysis will help identify whether there are significant relationships between digital literacy and the quality of education as well as social harmony.
- c) **Linear Regression:** If necessary, linear regression analysis may be conducted to evaluate the impact of digital literacy on the quality of education and social harmony. The regression model will provide information regarding the contribution of digital literacy in explaining the variations in the quality of education and social harmony.
- d) **Qualitative Analysis (if applicable):** If there are open-ended questions in the questionnaire, the data will be analyzed using a thematic analysis approach to extract themes and patterns from the students' responses.

III. RESULT AND DISCUSSION

This research involves collecting data from respondents at schools to understand the extent to which digital literacy has been adopted by students and how these skills impact their educational quality and social interactions. Data from respondents provide a clear picture of technology usage, confidence levels in evaluating digital information, and awareness of the importance of digital security.

A large majority of respondents (98.5%) use the internet daily or several times a week to seek information, indicating a high frequency of internet use among them. Only a small number of respondents (1.5%) rarely or very rarely use it. These results show that the internet plays a central role in information access, and marketing, communication, and education strategies could be effective if digitally based, given the high level of internet usage among respondents.

Data shows that smartphones dominate as the primary device used to access the internet by most respondents (96.7%). This indicates the importance of optimizing mobile-based services, applications, and content to reach users more effectively. The use of computers/laptops and other devices is very minimal (a total of only 3%), demonstrating a shift in device usage behavior towards more mobile-friendly platforms. For digital marketing strategies, communication, and application development, the main focus should be directed towards mobile platforms, given the dominance of smartphone users.

Most respondents (82.7%) have a relatively high level of confidence in evaluating information on the internet, indicating an adequate level of digital literacy. However, there are some respondents who still feel uncertain (13.6%), highlighting the importance of developing information literacy skills among internet users. While only 3.7% feel very confident, this reflects that there is still room to enhance critical abilities and knowledge in evaluating information more accurately. Efforts to improve digital literacy through education and training could help boost the public's confidence and ability to verify the information they find online.

Most respondents (70.3%) often or very often use the internet to search for information to complete school tasks, reinforcing the critical role of the internet in today's academic activities. However, 29.4% of respondents only use the internet occasionally. This may indicate variability in students' learning methods or differences in internet accessibility. For educational institutions, these results could indicate the need to improve digital literacy and provide more affordable and credible online resources so that students can make optimal use of the internet for learning activities.

The Importance of Digital Literacy in Enhancing the Quality of Education and Social Harmony

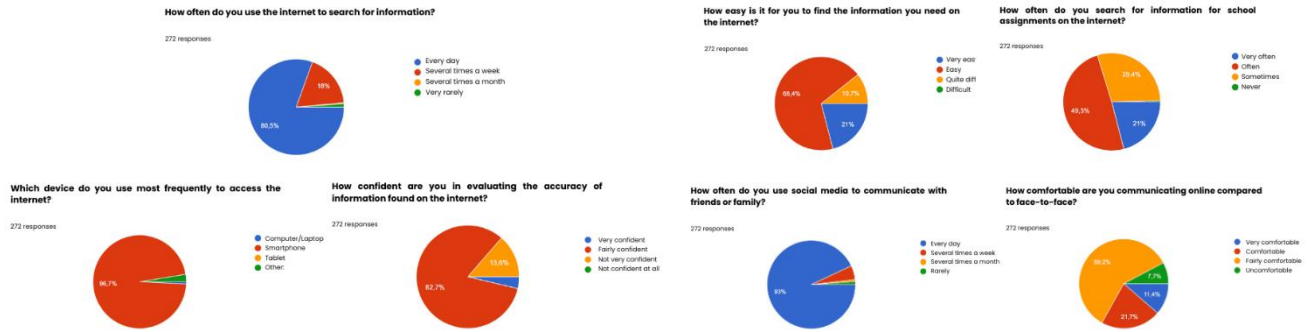

Figure 1. Respondents' Answers Related to Technology Usage, Information Competency, and Communication Competency

A large majority of respondents (89.4%) find it easy or very easy to find the information they need on the internet, showing that the internet is considered an effective and efficient tool for information searching. However, 10.7% of respondents find it difficult, emphasizing the importance of improving digital literacy and better information search skills. For educational platforms or information services, this highlights an opportunity to provide clearer guidance in navigating and filtering online information, thus enhancing the search experience for users who still find it challenging.

Most respondents (93%) use social media every day to communicate with friends or family, indicating the importance of social media in daily life as the main communication tool. However, a small portion of respondents (7.9%) use social media less frequently, either a few times a week, monthly, or very rarely. These results suggest that social media has become an integral part of social interaction, and for most people, it serves as the primary platform for efficient and easy communication.

Most respondents (92.3%) feel at least fairly comfortable communicating online, which shows that digital communication has been widely accepted in daily life. However, the majority are still in the "fairly comfortable" category (59.2%), indicating that they still value face-to-face communication and see online communication as a practical but not always ideal option. Meanwhile, 7.7% feel uncomfortable with online communication, highlighting a preference for direct interaction and potential difficulty in adapting to technology-based communication.

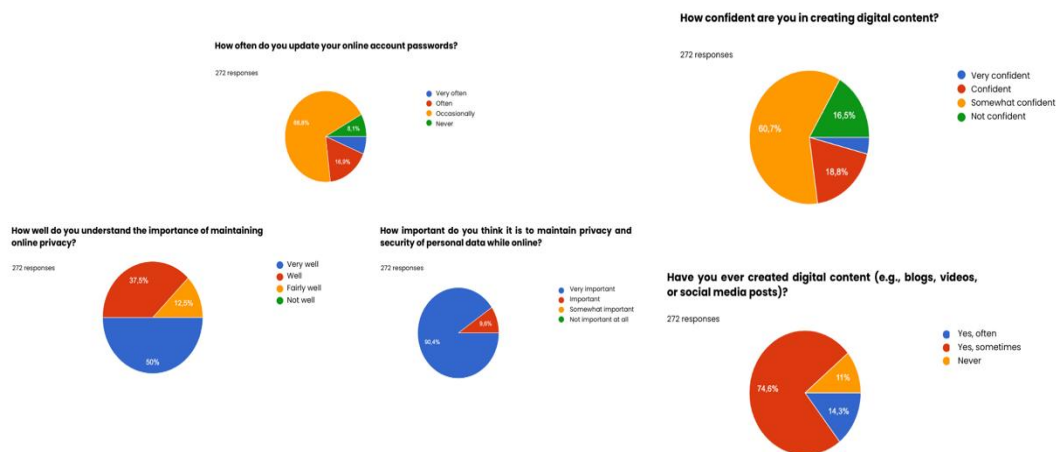

Figure 2. Respondents' Answers Related to Content Creation Competency and Security Competency

A large majority of respondents (88.9%) have experience creating digital content, either frequently or occasionally, showing that many people are now engaged in creative activities on digital platforms. This reflects the growth of digital culture in society, where content creation has become more accessible and increasingly popular. However, 11% of respondents have never created digital content, indicating there is room to increase participation in this activity, perhaps through education and training on how to create and share content effectively.

Most respondents (79.5%) feel at least somewhat confident in creating digital content, showing that many people feel capable of engaging in this creative activity. However, only 22.8% of respondents feel very confident or confident, indicating the potential to boost this confidence through training, support, and skill development. On the other hand, 16.5% of respondents who lack

The Importance of Digital Literacy in Enhancing the Quality of Education and Social Harmony

confidence show a need for more in-depth interventions, such as workshops or courses on digital content creation to build their confidence and skills.



Figure 3. Presentation and Discussion on Digital Security to the Students of SMA Negeri 3 Sumedang

Survey results show that 99% of respondents consider it important to maintain privacy and personal data security online. This indicates a very high level of awareness about the risks and challenges associated with internet use. This awareness can be used as a foundation to increase education and training related to best practices in data security, helping individuals to be more prepared to face challenges in the digital world. Additionally, this high level of concern also signals to online service providers to prioritize user security and privacy in their product and service development.

Survey results show that 87.5% of respondents feel they have a good or very good understanding of the importance of maintaining online privacy. This reflects a high level of awareness among respondents about privacy issues in the digital world. However, with 12.5% of respondents feeling they only have a fair understanding, there remains an opportunity to improve education about online privacy. Increasing understanding among all respondents can be achieved through education programs and training that focus on best practices for protecting privacy, raising awareness about risks, and strengthening skills in using tools and techniques to effectively protect personal data.

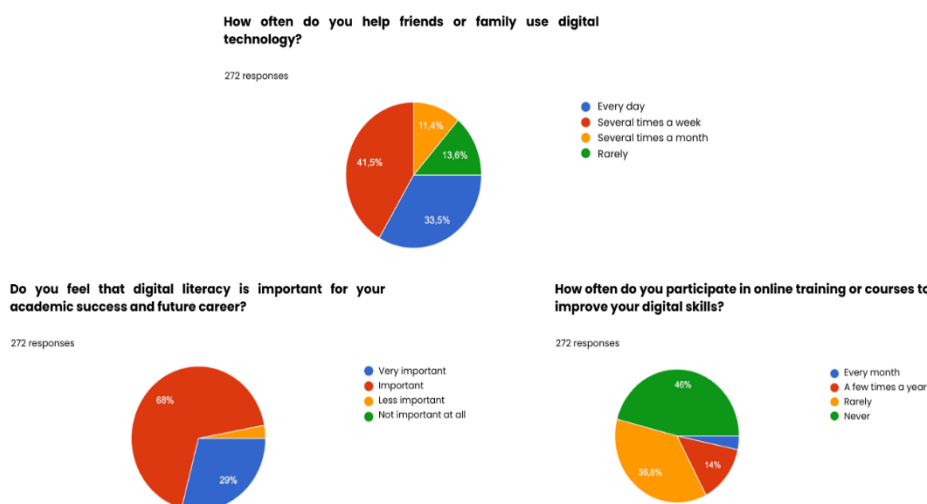

Figure 4. Respondents' Answers Related to Strengthening and Applying Digital Literacy

Survey results show that 75.1% of respondents update their passwords less frequently than recommended (i.e., "sometimes" or "never"). This indicates an urgent need to improve awareness and practices related to cybersecurity among respondents. Although most respondents have knowledge about the importance of updating passwords, the actual action of doing so regularly still needs to be improved. Education and training focused on cybersecurity best practices, such as how to choose strong passwords and set reminders to update passwords, can help improve these habits and ultimately reduce the risk of data breaches and hacking.

The Importance of Digital Literacy in Enhancing the Quality of Education and Social Harmony

Survey results show that 82.8% of respondents (rarely and never) are not actively participating in online training or courses to improve digital skills. This indicates a major challenge in building awareness and motivation for digital skill development among respondents. Education on the importance of digital skills and how online training can help in careers and daily life is greatly needed. Additionally, online course providers and educational institutions can play an active role in facilitating accessibility and attracting participants through relevant, engaging, and flexible programs.

Survey results show that 97% of respondents (very important and important) believe that digital literacy is an important element for academic and career success. This reflects a high level of awareness among respondents about the relevance of digital skills in the modern era. Although only 29% feel that digital literacy is "very important," the combination of both groups indicates an urgent need to enhance digital literacy among respondents. Therefore, educational institutions and organizations need to provide more support, resources, and training in digital literacy so respondents can fully utilize these skills in their future studies and careers.

Survey results show that 75% of respondents (daily and several times a week) actively help friends or family with the use of digital technology. This shows a strong level of collaboration and mutual support among respondents in facing technological challenges. High involvement in helping others can boost respondents' own confidence and digital skills, as well as strengthen social relationships. To further maximize this positive impact, educational or training programs in digital technology can help more individuals feel comfortable and competent, enabling them to provide more effective support to those around them.

The analysis results from the survey indicate a strong relationship between digital literacy, digital culture, and social harmony among students. In this context, digital literacy refers to an individual's ability to effectively use digital technology, while digital culture encompasses norms, values, and practices related to technology use in society.

IV. CONCLUSIONS

This research aimed to explore the relationship between digital literacy, educational quality, and social harmony among students, particularly focusing on how these aspects are influenced by the widespread use of digital technology. By surveying a representative sample of students, this study has provided valuable insights into their digital habits, perceptions of online interactions, and awareness of digital security. The findings reveal a nuanced understanding of how digital literacy not only facilitates educational engagement but also fosters social interactions and community cohesion.

A. The Role of Digital Literacy in Education

A significant finding of this research is the pivotal role digital literacy plays in students' educational experiences. With an overwhelming majority (98.5%) of respondents utilizing the internet daily for information gathering, it is evident that digital platforms have become essential for academic activities. This high frequency of internet use aligns with contemporary educational practices, where digital resources are increasingly integrated into curricula. Moreover, 70.3% of students reported using the internet frequently for school tasks, underscoring its importance in their learning processes.

However, while most respondents (82.7%) expressed confidence in evaluating online information, a substantial portion still felt uncertain about their skills. This indicates a crucial area for intervention. Educational institutions must prioritize enhancing digital literacy through tailored training programs that equip students with the necessary skills to critically assess information sources. This could involve workshops focusing on information evaluation, effective research strategies, and best practices for navigating online content.

B. The Impact of Digital Communication on Social Interactions

The research also highlights the profound impact of digital communication on students' social interactions. The data revealed that 93% of respondents engage in daily social media communication, demonstrating its integral role in their lives. While most students feel comfortable communicating online, there remains a preference for face-to-face interactions among a significant segment of the population. This ambivalence points to an evolving communication landscape where digital interactions complement, rather than replace, traditional socializing.

Furthermore, the substantial proportion of students (88.9%) involved in creating digital content reflects the democratization of content production in the digital age. This trend not only fosters creativity but also cultivates a sense of community among peers. Educational initiatives should therefore encourage students to participate in digital content creation actively, helping them gain confidence and skills in this area. Programs that facilitate collaborative content creation can enhance both digital literacy and social cohesion.

C. Awareness and Practices Regarding Digital Security

Another critical aspect of the findings pertains to digital security awareness among students. An impressive 99% of respondents recognized the importance of maintaining privacy and personal data security online. This level of awareness

The Importance of Digital Literacy in Enhancing the Quality of Education and Social Harmony

is commendable and serves as a solid foundation for further education on digital security best practices. Despite this, the research revealed concerning gaps in actual practices, particularly regarding password management, with 75.1% of respondents updating their passwords less frequently than recommended.

These discrepancies highlight an urgent need for targeted educational interventions focused on cybersecurity. Institutions must provide comprehensive training on how to create strong passwords, the importance of regular updates, and the potential risks of neglecting digital security practices. By improving students' practical skills in cybersecurity, educational institutions can empower them to protect their online identities effectively.

D. The Intersection of Digital Literacy, Culture, and Social Harmony

A noteworthy conclusion drawn from the survey analysis is the strong interrelationship between digital literacy, digital culture, and social harmony. Digital literacy encompasses not only the ability to use technology effectively but also involves understanding the norms, values, and practices associated with digital engagement. As students navigate these digital landscapes, their interactions and the cultural contexts surrounding their use of technology play crucial roles in shaping their educational experiences and social relationships.

The finding that 97% of respondents view digital literacy as essential for academic and career success indicates a broader recognition of its significance beyond mere technology usage. This awareness underscores the need for educational institutions to cultivate a culture that prioritizes digital literacy as a fundamental component of student development. By fostering a digital culture that promotes collaborative learning, critical thinking, and ethical online behavior, schools can enhance both educational outcomes and social cohesion.

E. The Importance of Peer Support in Digital Skill Development

Moreover, the data indicating that 75% of respondents actively assist friends and family with digital technology usage highlights the community-oriented approach to digital literacy. This collaboration not only reinforces students' confidence in their skills but also strengthens social bonds within their networks. Educational programs should harness this community spirit by encouraging peer-led initiatives, where students can share knowledge and skills with one another.

Creating opportunities for students to collaborate on digital projects or provide tech support to peers can enhance their learning experience and foster a culture of mutual assistance. Such initiatives can further bolster social harmony by promoting teamwork and shared responsibility within the student community.

F. Recommendations for Future Research

While this study has shed light on the current state of digital literacy, educational quality, and social interactions among students, further research is warranted to explore the long-term implications of these findings. Future studies could examine how digital literacy evolves over time and its impact on academic performance and social dynamics. Additionally, investigating the role of educators in facilitating digital literacy and addressing disparities in access to technology could provide valuable insights into enhancing educational practices.

Furthermore, qualitative research could delve deeper into students' experiences with digital literacy, exploring their challenges and successes in navigating the digital landscape. Such research can inform the development of more nuanced educational programs that address the diverse needs of students.

In summary, this research highlights the critical importance of digital literacy in enhancing educational quality and fostering social harmony among students. The findings underscore the need for educational institutions to prioritize digital literacy training, promote cybersecurity awareness, and cultivate a supportive digital culture. By addressing these areas, schools can empower students to navigate the complexities of the digital world confidently, enhancing their academic and social outcomes in an increasingly interconnected society. As digital technologies continue to evolve, the ongoing development of digital literacy will be essential for preparing students for future challenges and opportunities.

REFERENCES

- 1) Boyd, D., & Ellison, N. B. (2007). *Social Network Sites: Definition, History, and Scholarship*. *Journal of Computer-Mediated Communication*, 13(1), 210-230. doi:10.1111/j.1083-6101.2007.00393.x.
- 2) Boyd, D. (2014). *It's Complicated: The Social Lives of Networked Teens*. Yale University Press.
- 3) Buckingham, D. (2007). *Digital Media Literacies: Rethinking Media Education in the Age of the Internet*. *Research in Comparative and International Education*, 2(1), 43-55.
- 4) Erstad, O. (2010). Digital Literacy in the 21st Century: A Review of Literature. *Education and Information Technologies*, 15(2), 167-183. doi:10.1007/s10639-010-9175-0
- 5) Gilster, P. (1997). *Digital Literacy*. Wiley.

The Importance of Digital Literacy in Enhancing the Quality of Education and Social Harmony

- 6) Haes, S., & Kenyon, C. (2007). Heutagogy: A New Model for Learning and Teaching in the Digital Age. The 6th International Conference on Networked Learning, 1-11.
- 7) Hague, C., & Payton, S. (2010). *Digital Literacy Across the Curriculum*. Futurelab.
- 8) Johnson, M. (2018). *Digital Literacy and Educational Outcomes: A Study of School Students*. Journal of Educational Technology, 15(3), 120-135.
- 9) Kementerian Pendidikan dan Kebudayaan Republik Indonesia. (2022). Laporan Survei Literasi Digital Siswa. Jakarta: Kementerian Pendidikan dan Kebudayaan Republik Indonesia.
- 10) Livingstone, S. (2020). *Digital Skills and Social Harmony in Schools*. Digital Society, 19(1), 98-112.
- 11) Livingstone, S. (2014). *Children's Digital Lives in the Era of the Mobile Internet*. Journal of Communication, 64(3), 689-713.
- 12) Livingstone, S., Haddon, L., & Görzig, A. (2012). *Children, Risk and Safety on the Internet: Research and Policy Challenges in Comparative Perspective*. Policy Press.
- 13) Potter, W. J. (2013). *Media Literacy*. SAGE Publications.
- 14) Pratama, D. (2023). *Etika Digital dan Pembelajaran Daring: Studi Empiris pada Siswa Sekolah Menengah*. Jurnal Pendidikan Digital, 11(5), 90-105.
- 15) Selwyn, N. (2011). *Education and Technology: Key Issues and Debates*. Bloomsbury Publishing.
- 16) Setiawan, R. (2022). *Pengaruh Literasi Digital terhadap Prestasi Belajar Siswa SMA di Era Pandemi*. Jurnal Teknologi Pendidikan, 14(4), 211-225.
- 17) UNESCO. (2011). *Media and Information Literacy Curriculum for Teachers*. Paris: UNESCO.
- 18) UNESCO (2018). *Digital Literacy in Education: Policies and Practices*. UNESCO.
- 19) Warschauer, M. (2003). Democracy and Digital Divide: The Role of Digital Literacy in Social Inclusion. Communications of the ACM, 46(1), 40-44. doi:10.1145/954121.954144
- 20) Zainal, M. (2021). *Inklusi Digital dalam Pendidikan Indonesia: Tantangan dan Peluang*. Jurnal Pendidikan Indonesia, 10(2), 45-59.



There is an Open Access article, distributed under the term of the Creative Commons Attribution – Non Commercial 4.0 International (CC BY-NC 4.0) (<https://creativecommons.org/licenses/by-nc/4.0/>), which permits remixing, adapting and building upon the work for non-commercial use, provided the original work is properly cited.

The Urgency of Integrating Femicide Norms to Achieve Gender Equality in the Sustainable Development Goals



Raja Ramadhan¹, Aditya Yuli Sulistyawan²

^{1,2}Faculty of Law Universitas Diponegoro

dr. Antonius Suroyo Street, Undip Tembalang Campus, Semarang

ABSTRACT: The Sustainable Development Goals (SDGs) prioritize the value of equality, including ensuring justice and gender equality, fulfilling women's rights, and ending violence against women. Many factors cause violence against women that occur today. One factor causing this is the inequality in relationships between genders, where women are in a subordinate position under men. If this problem is not addressed immediately, it will harm women, especially those in vulnerable conditions. The goal of gender equality in the SDGs is to ensure that women gain security and avoid violence. In its development, this gender inequality causes gender-based violence. This problem leads to femicides as the peak of gender-based violence. Femicide is a term for violence against women. There should be a specific norm or regulation on femicides because, in their implementation, acts that are classified as femicides have not been regulated juridically. The implication is that femicides will be the same as other general crimes. This will have consequences for the government's responsibility for femicide victims and the application of sanctions against femicide perpetrators. Therefore, to achieve true equality between women and men, consistent, solutive, and up-to-date efforts are needed to overcome these problems.

KEYWORDS: SDGs, femicide, violence, law.

A. INTRODUCTION

Improving or maintaining existing habits in society is commonly called cultural development. This proves the dynamic nature of culture and society from time to time which can be interpreted as a global influence.¹ Culture is very crucial because it has a great influence on people's lifestyles and thoughts. Since the beginning of human life, cultural development has been the starting point for identity development in the form of changes in human nature that are the basis for the community's development. The cognitive revolution is the beginning of human nature changes. The term "revolution" explains that these changes are drastic and change people's perspectives and cultures much faster than their biological changes.²

According to Auguste Comte, the development of the human mindset goes through three stages, namely theological, metaphysical, and positivist stages where the positivist period like social, political, and economic factors are the main variables creating social conditions such as gender roles, power structures, and conflicts between groups.³ This cultural development has created very complex values for humanity raising the challenge of implementing these values following the era. One of the products of cultural development is the patriarchy. Patriarchy is a system believing that there is dominance from men to women as a form of compensation for being subordinated due to social class, race, and other forms of inequality.⁴

In the past, there was a division of labor based on gender. Gerda Lerner supports this in *The Creation of Patriarchy* book (1986) that men controlled an absolute restriction of women's abilities and authority. This phenomenon became the initial milestone in the emergence of patriarchy and became very influential with the role of gender in social construction. The significant

¹ Ife, J, Tesoriero. F. *Community development: community-based alternatives in on age of globalization*. Australia. Pearson Education. 2001.

² Harari, Y. V. *Sapiens: a Brief History of Humankind*. New York. Harper. 2015.

³ Arifin, L. M. S. *Filsafat Positivisme Auguste Comte Dan Relevansinya Dengan Ilmu-Ilmu Keislaman. Interaktif: Jurnal Ilmu-Ilmu Sosial*, Volume 12 No. 2, p. 135.

⁴ Johnson, A. G. *The gender knot: Unraveling our patriarchal legacy*. Temple University Press. Philadelphia. 2005.

The Urgency of Integrating Femicide Norms to Achieve Gender Equality in the Sustainable Development Goals

difference in treatment between men and women has created inequality in various social aspects. One form of gender discrimination is the domestication of one gender, namely women. Women and men in Indonesia grow up with different roles based on the division of roles formed by this construction. Thus, it is appropriate that the Sustainable Development Goals (SDGs) place gender equality as a top priority. Gender equality (SDGs) is fundamental because this equality is not only about providing equal rights but also dismantling the social and cultural structures that discriminate against women. The SDGs seek to empower women by providing equal access to education, employment, and political participation. One of the key indicators in achieving gender equality is reducing gender-based violence, increasing women's involvement in the formal sector, and ensuring policies that support the balance of domestic roles between men and women.

Currently, the SDGs are a universally agreed agenda that is a continuation and development of the Millennium Development Goals (MDGs).⁵ Over the past fifteen years, the MDGs have made no significant progress in addressing gender inequality. This is the main reason that the SDGs focus on gender equality.⁶ In the SDGs goals related to gender equality, some targets must be achieved, one of which is to end and eliminate any forms of violence and discrimination against women both in private and public spaces.⁷ Although gender equality has become the main goal at the international level, in its implementation, Indonesia still has gender problems that need to be overcome, one of which is gender-based violence.

Gender-based violence includes various forms of physical violence, such as beatings, rape, trafficking of women and children, honor killings, and sexual violence. In addition, gender-based violence also includes more extreme actions, namely structural violence, cultural violence, and femicide.⁸ Violence against women is considered the same as gender-based violence when viewed from a feminist perspective.⁹ This problem is based on the fact that there is inequality in gender relations that places women as subordinate to men. The position is one of the causes of violence against women that has occurred so far.¹⁰ In its development, violence and discrimination against women, including girls, are called femicides.¹¹ Of course, violence is one of the real forms of violations of human rights (HAM) as well as crimes against human dignity. Violence is not justified in any form of it. Therefore, it can be concluded that gender dominance causes gender injustice and becomes one of the causes of violence, namely unfair treatment from those who have stronger control over those who have weaker control.¹² Gender injustice driven by the dominance of one gender, usually a man, has created a power imbalance that is at the root of various forms of violence, especially against women. Gender-based violence is often rooted in patriarchal views that place women in subordinate positions, both domestically and publicly. This is reflected in various forms of emotional, physical, psychological, and sexual violence experienced by women.

The results of statistical data from the National Commission on Violence Against Women (Komnas Perempuan) supported by the Directorate General of The Religious Court Body (BADILAG), have shown a very high number of violence against women. In the 2023 Year-End Notes (CATAHU), Komnas Perempuan noted a reduction in case reports from 339,782 to 289,111 in 2023. The decrease in cases from 3,442 to 3,303 cases at Komnas Perempuan showed that Komnas Perempuan received an average of 11 cases daily.¹³

With those data, it can be agreed that gender discrimination is a real and complex problem in our social environment. Gender discrimination must be resolved immediately because it has the potential to create a butterfly effect that will cause new problems for the country. Therefore, to achieve true equality between men and women, consistent, solutive, and up-to-date efforts are needed to overcome this problem. In this case, the presence of the law can be a strong foundation to support gender equality in Indonesia.

⁵Hadiz, L. DARI MDGs KE SDGs: Memetik Pelajaran dan Menyiapkan Langkah Konkret. Jakarta, Smeru Research Institute. 2017.

⁶Halizah, L. R., & Faralita, E. Budaya patriarki dan kesetaraan gender. Wasaka Hukum, Vol. 11 No. (1), 2023. p. 24.

⁷Nasional, K. P. P.. Bappenas. Ringkasan Metadata Indikator Tujuan Pembangunan Berkelanjutan (TPB). *Sustainable Development Goals (SDGS) Indonesia*. Jakarta. 2017.

⁸ Azizah, N., & Rahmawati, F. Kekerasan Berbasis Gender di Pakistan. *Prosiding UMY Grace*, Vol 1, No. 2.2020. p. 329

⁹ Harnoko, Bambang Rudi. Dibalik tindak kekerasan terhadap perempuan. *MUWAZAH: Jurnal Kajian Gender*, Volume 2, Number 1 2012, p. 181.

¹⁰ Ani Purwanti, Kekerasan Berbasis Gender. Yogyakarta, Bildung. 2020. p. 32.

¹¹ World Health Organization (2012).

¹² Gustin, W. I.. UPAYA ISTRI SEBAGAI KORBAN KEKERASAN DALAM MENYIKAPI KEKERASAN DALAM RUMAH TANGGA (KDRT) DI KABUPATEN MOJOKERTO. *Kajian Moral Dan Kewarganegaraan*, Volume 5, No. 03. 2017. p. 768

¹³ Komnas Perempuan, CATAHU TAHUN 2023, Momentum Perubahan: Peluang Penguatan Sistem Penyidikan di Tengah Peningkatan Kompleksitas Kekerasan terhadap Perempuan. <https://komnasperempuan.go.id/siaran-pers-detail/siaran-pers-komnas-perempuan-tentang-peluncuran-catatan-tahunan-kasus-kekerasan-terhadap-perempuan-tahun-2023#:~:text=CATAHU%202023%20mencatat%20jumlah%20kekerasan%20terhadap%20perempuan%20pada,Komnas%20Perempuan%20dapat%20dilihat%20dalam%20Lampiran%20Lembar%20Fakta%29>. Accessed on 7 Oktober 2024.

The Urgency of Integrating Femicide Norms to Achieve Gender Equality in the Sustainable Development Goals

To find and solve the law enforcement problem, an effort is needed to reconsider the relationship between law and society. This is based on the fact that the law functions for society and society needs the law to regulate their social life.¹⁴ Therefore, it can be seen that the need to carry out legal thinking returns to its basic philosophy, namely law for humans. In a country with cultural diversity like Indonesia, the need for laws to ensure the stability and security of its citizens is becoming increasingly crucial. As Prof. Satjipto Rahardjo said, the study of Indonesian law and society must be seen from a sociological and anthropological perspective to better understand different cultures and traditions.¹⁵ With this philosophy, humans are the determining factor and legal orientation. Therefore, the idea of Progressive Law initiated by Prof. Satjipto Rahardjo appeared where the law is in charge of serving humans, not the other way around. So, it can be said that law is an institution that cannot be separated from human needs.¹⁶ From this thought, we can all know that law in Indonesia must be studied by considering the unique social context in this country. Prof. Satjipto's statement is in line with the legal goals proclaimed by Gustav Radbruch, namely utility, certainty, and justice.¹⁷ This means that laws must continue to be formulated according to the needs of the community with the government as the regulator that functions as an instrument that accommodates the community's needs. Based on this explanation, it can be concluded that to overcome the irregularities that occur in society, it is necessary to establish a law as a social control in society. Thus, law as social control aims to achieve harmony between stability, and changes in society.¹⁸

B. DISCUSSION

The Republic of Indonesia is a country that grows and develops based on law (*rechtsstaat*). Based on this statement, every action taken by the state and its citizens must be based on positive law. This is very crucial for the sustainability of mankind because the law functions as a tool to regulate human behavior in achieving social welfare.¹⁹ The application of the concept of the state of law needs to consider the values that live and develop in society. This consideration will be a very fundamental aspect considering the existence of cultural relativism in each region. In line with this adjustment, Indonesia has Pancasila which is positioned as the source of national law and the nation's ideology.²⁰ Essentially, the application of Pancasila values in the concept of the state of law aims to fulfill the mandate contained in it. One of the values of Pancasila is to create social justice as enshrined in the fifth precept of Pancasila which reads "Social justice for all Indonesian people." The precept directly explains that the state aims to provide protection and guarantee of social justice for all Indonesian people. Starting from this, Pancasila which is abstract needs to be concretized into a regulation that has legal force, so that the values of Pancasila can be implemented in society. The values of Pancasila have been concretized through the 1945 Constitution of the Republic of Indonesia (Constitution of the Republic of Indonesia) as the country's constitution. One of the legalizations of the value of social justice is human rights explained in CHAPTER XA OF THE CONSTITUTION OF THE REPUBLIC OF INDONESIA. Article 28A states, "Every person has the right to live and to maintain their lives and livelihood." In more detail, Article 28G also mandates that:²¹

- (1) "Every person has the right to protection of self, family, honor, dignity, and their property, and has the right to security and protection from threats of fear to exercise or not to exercise his human rights".
- (2) "Every person has the right to be free from torture or inhumane and degrading treatment, and has the right to receive political asylum from another country".

Furthermore, Article 28I of the Constitution of the Republic of Indonesia also states that:²²

- (1) "Right to live, right to be free from torture, right of freedom of thought and conscience, right of religion, right to be free from slavery, right to be recognized as a person before the law, and right not to be prosecuted under a law with retrospective effect are all human rights that cannot be deprived under any circumstances".
- (2) "Every person has the right to be free from discriminative treatment based upon any grounds and has the right to protection from such discriminative treatment.

¹⁴ Orlando, G.. Hukum Sebagai Kontrol Sosial dan Social Engineering. *Tarbiyah Bil Qalam: Jurnal Pendidikan Agama Dan Sains*, Vol. 7 No. 1. 2023. P. 33.

¹⁵ Turiman, T. Memahami Hukum Progresif Prof Satjipto Rahardjo Dalam Paradigma "Thawaf". *jurnal Hukum Progresif*. 2010. p. 2

¹⁶ Bernard L.Tanya, et. al. Strategi Tertib Manusia Lintas Ruang dan Generasi. Yogyakarta, Genta Publishing, 2010, p.20

¹⁷ Dhikshita, I. B. G. A. Manifestasi Teori Tujuan Hukum Gustav Radbruch dan Mazhab Positivisme di Indonesia. <https://advokatkonstitusi.com>. 7 Oktober 2024.

¹⁸ Iriani, D. Hukum sebagai alat kontrol sosial dan sistem supremasi penegakan hukum. *Justicia Islamica*, Vol. 8 No. 1. 2011. p. 147.

¹⁹ Soedikno Mertokusumo, Mengenal Hukum. Yogyakarta, Atmajaya Publishing, 1999, p.65

²⁰ Siallagan, H. Penerapan prinsip negara hukum di Indonesia. *Sosiohumaniora*, Vol. 18 No. 2. 2016. 122-128. p. 135

²¹ See Article 28A of the 1945 Constitution of the Republic of Indonesia

²² See Article 28I of the 1945 Constitution of the Republic of Indonesia

The Urgency of Integrating Femicide Norms to Achieve Gender Equality in the Sustainable Development Goals

- (3) Cultural identities and rights of indigenous people are respected in accordance with the development of times/age and civilizations.
- (4) Protection, advancement, enforcement, and fulfillment of human rights are responsibilities of the state, especially the government.
- (5) For the purpose of enforcing and protecting human rights in accordance with the principle of a constitutional democratic state, the implementation of human rights is guaranteed, regulated, and set forth in legislation.

From these articles, it can be seen that in terms of *das sollen*, the state hopes to create protection and guarantee of rights regardless of gender to achieve gender equality.

In its development, the mandate of the Constitution of the Republic of Indonesia must be concretized again in the law. This is in line with the Stufenbau Theory initiated by Hans Kelsen. Stufenbau Theory can be interpreted as the explanation of the origin of law until the formation of positive legal norms. This theory argues that the existence of positive law must be arranged in a structured manner from general to specific rules. This process is called concretization.²³ In this case, the mandate in the Constitution of the Republic of Indonesia related to protection has been concretized through laws and regulations. The concrete form of this protection is a regulation in the form of the Criminal Code (KUHP). Unfortunately, the Criminal Code only regulates violence in general, namely in Article 291, Article 338, Article 339, Article 340, Article 351, Article 353, Article 354, and Article 355. Based on this fact, it can be seen that there has been no integration between the definition and criminal sanctions that apply in Indonesia in the national law. This problem results in many murder cases that should be classified as femicides instead of other general crimes. The fact that femicides are classified as a general crime is proven by the high gap between the number of murder cases against women and the national regulations governing femicides.²⁴ The Indonesian National Police recorded 1,491 murder cases in 2015, 1,292 cases in 2016, 1,1150 cases in 2017, 1,024 cases in 2018, and 964 cases in 2019. However, this data has not been grouped by motive or gender, so data on femicides in Indonesia cannot be properly identified.²⁵ In addition, femicides have not been recognized in social sciences that study crime and victims, or in the training of law enforcement officials to strengthen laws with a gender perspective. Therefore, femicides have not been legally recognized normatively by law enforcement officials, academics, and state institutions. Based on this problem, the state must immediately describe femicide as criminal which is a gender-based crime.

Sociologically, the number of femicide cases in Indonesia has increased significantly, quadrupling from 2017 to 2024. The most femicide perpetrators are husbands/ex-husbands or partners/ex-partners who commit femicides due to intimate factors. Motivation for murder due to hurt, revenge, jealousy, or internal conflict are the most common motives in women in the productive age range from 21 to 40 years. Data collected by Komnas Perempuan shows that the most frequent cases of femicides are found in Java and Sumatra. The number of cases of femicides on the islands has also led to many reports related to cases of femicides in the name of culture. Such cases are often difficult to be sanctioned because there is a justification from the environment for the femicides which is classified as a cultural sanction.²⁶

This problem is certainly very ironic considering that Indonesia is one of the countries that ratified the Convention on the Elimination of All Forms of Discrimination against Women (CEDAW). The Republic of Indonesia has ratified CEDAW through Law Number 7 of 1984 concerning the Ratification of the Convention on the Elimination of All Forms of Discrimination against Women. In CEDAW, it is very clear that Article 1 prohibits all forms of discrimination against women. Furthermore, CEDAW also defines femicides as murder based on female gender. The formulation of this covenant states that the state is obliged to implement a policy of eliminating discrimination against women, including violence against women. The obligation to provide this protection is absolute. Therefore, no reason can justify the act of femicide, including cultural, economic, or religious reasons. In addition, CEDAW also regulates access to justice. This is stated in General Recommendation Number 33 which states that the state is obliged to uphold justice even if the female victim dies. The enforcement can be in the form of a case investigation process, providing compensation to the family, the necessary recovery, and punishing the perpetrators. In addition, there is also a global commitment to overcome and eliminate femicides. This is proven by the Document on the Outcome of the Beijing+25 Regional Review Meeting

²³ FX. Adji Samekto, Menelusuri Akar Pemikiran Hans Kelsen Tentang *Stufenbeautheorie* Dalam Pendekatan Normatif Filosofis. *Jurnal Hukum Progresif*, Vol. 7 No.1. 2019. p. 14.

²⁴ Agsel, A.. PENGATURAN KEKERASAN BERBASIS GENDER SIBER (KBGS) DAN PERMASALAHAN PENEGAKAN HUKUMNYA DALAM SISTEM HUKUM DI INDONESIA (Studi Kasus Kekerasan Seksual Berbasis Gender Siber dalam Putusan Nomor: 785/Pid. Sus/2020/PN Tjk, dan Putusan Nomor: 471/Pid. Sus/2022/PN Tjk di Kota Bandar Lampung). Doctoral Dissertation of Doctor of the Faculty of Law of Universitas Lampung. p 21.

²⁵ Komnas Perempuan, op. cit. p. 2.

²⁶ Ibid. p. 20.

The Urgency of Integrating Femicide Norms to Achieve Gender Equality in the Sustainable Development Goals

held by the UN Economic Commission for Europe in October 2019. In its recommendations, the document expresses its support for the Femicide Watch initiative. This recommendation calls on all countries to establish a multidisciplinary national body such as the Femicide Watch to prevent femicides and gender-based murder, particularly against women.

The types and definitions of femicides, according to findings from Komnas Perempuan and the United Nations, are not optimally integrated because national and local laws themselves have not provided a legally normative definition of gender-based violence and murder based on gender just because they are women. Based on this situation, Indonesia as the state of law that also ratifies CEDAW needs to formulate new norms or regulations related to femicides. This aims to separate femicides from general criminal acts. This separation will have implications for the state's obligations and responsibilities towards femicide victims.

C. CONCLUSION

Gender discrimination in Indonesia arises due to a patriarchal culture that has grown for a long time. This culture results in differences in treatment between men and women, including security. Data has shown that there is wage inequality caused by gender differences. This must certainly be overcome immediately because it is discrimination which is contrary to Pancasila and the mandate of the Constitution of the Republic of Indonesia. In responding to this inequality, the government is trying its best to solve this problem. The government established binding regulations on human rights and protection and security in the hope of reducing the level of violence experienced by women. However, the regulations only regulate violence in general. The government needs to immediately formulate new norms or regulations that accommodate sanctions against femicide perpetrators and the protection that must be obtained by femicide victims. It is hoped that the government can quickly integrate femicide as a gender-based crime of murder in the criminal law and ratify the Sexual Violence Crime Bill as a means of eliminating sexual violence against women comprehensively to overcome this inequality to achieve the Sustainable Development Goals (SDGs).

REFERENCES

Academic Papers

- 1) Agsel, A.. PENGATURAN KEKERASAN BERBASIS GENDER SIBER (KBGS) DAN PERMASALAHAN PENEGAKAN HUKUMNYA DALAM SISTEM HUKUM DI INDONESIA (Studi Kasus Kekerasan Seksual Berbasis Gender Siber dalam Putusan Nomor: 785/Pid. Sus/2020/PN Tjk, dan Putusan Nomor: 471/Pid. Sus/2022/PN Tjk di Kota Bandar Lampung). Disertasi Doktoral Fakultas Hukum Universitas Lampung.
- 2) Arifin, L. M. S.. Filsafat Positivisme Auguste Comte Dan Relevansinya Dengan Ilmu-Ilmu Keislaman. *Interaktif: Jurnal Ilmu-Ilmu Sosial*, Volume 12 No. 2. 2020.
- 3) Azizah, N., & Rahmawati, F. Kekerasan Berbasis Gender di Pakistan. *Prosiding UMY Grace*, Vol 1, No. 2. 2020.
- 4) FX. Adji Samekto, Menelusuri Akar Pemikiran Hans Kelsen Tentang *Stufenbeautheorie* Dalam Pendekatan Normatif Filosofis. *Jurnal Hukum Progresif*, Vol. 7 No.1. 2019.
- 5) Gustin, W. I.. UPAYA ISTRI SEBAGAI KORBAN KEKERASAN DALAM MENYIKAPI KEKERASAN DALAM RUMAH TANGGA (KDRT) DI KABUPATEN MOJOKERTO. *Kajian Moral Dan Kewarganegaraan*, Volume 5, No. 03. 2017. p. 768
- 6) Hadiz, L. DARI MDGs KE SDGs: Memetik Pelajaran dan Menyiapkan Langkah Konkret. Jakarta, Smeru Research Institute. 2017.
- 7) Halizah, L. R., & Faralita, E. Budaya patriarki dan kesetaraan gender. *Wasaka Hukum*, Vol. 11 No. (1), 2023.
- 8) Harnoko, Bambang Rudi. Dibalik tindak kekerasan terhadap perempuan. *MUWAZAH: Jurnal Kajian Gender*, Volume 2, Nomor 1 2012.
- 9) Iriani, D. Hukum sebagai alat kontrol sosial dan sistem supremasi penegakan hukum. *Justicia Islamica*, Vol. 8 No. 1. 2011. hlm.
- 10) Lusiyanti. Kesenjangan Penghasilan Menurut Gender di Indonesia. *Jurnal Litbang Sukowati* 4, (1)
- 11) Orlando, G.. Hukum Sebagai Kontrol Sosial dan Social Engineering. *Tarbiyah Bil Qalam: Jurnal Pendidikan Agama Dan Sains*, Vol. 7 No. 1. 2023.
- 12) Siallagan, H. Penerapan prinsip negara hukum di Indonesia. *Sosiohumaniora*, Vol. 18 No. 2. 2016. 125.
- 13) Turiman, T. Memahami Hukum Progresif Prof Satjipto Rahardjo Dalam Paradigma "Thawaf". *Jurnal Hukum Progresif*. 2010.

Article From Internet

- 1) Anonim, 2014. Ideologi Patriarki pada Iklan Komersial. <https://dkv.binus.ac.id>.
- 2) Dhikshita, I. B. G. A. Manifestasi Teori Tujuan Hukum Gustav Radbruch dan Mazhab Positivisme di Indonesia. <https://advokatkonstitusi.com>.

The Urgency of Integrating Femicide Norms to Achieve Gender Equality in the Sustainable Development Goals

- 3) Komnas Perempuan. "Lembar Fakta dan Poin Kunci Catatan Tahunan Komnas Perempuan Tahun 2022" Website komnasperempuan.go.id, 2022. <https://komnasperempuan.go.id/download-file/736>. Komnas Perempuan. "Mencapai Kesetaraan Gender dan Memberdayakan Kaum Perempuan" Website [kemempna.go.id](https://www.kemempna.go.id), 2017. <https://www.kemempna.go.id/index.php/page/read/31/1439/mencapai-kesetaraan-gender-dan-memberdayakan-kaum-perempuan>.
- 4) OCHR. "Declaration on the Elimination of Violence against Women" Website [ohcr.org](https://www.ohchr.org/en/instruments-mechanisms/instruments/declaration-elimination-violence-against-women), 2018. <https://www.ohchr.org/en/instruments-mechanisms/instruments/declaration-elimination-violence-against-women>.
- 5) Tunardy, W. T, 2021. Fungsi dan Tujuan Hukum Menurut Para Ahli. <https://jurnalhukum.com>.
- 6) UN Women. "Women and the Sustainable development Goals (sdGs)" Website [unwomen.org](https://www.unwomen.org/en/news/in-focus/women-and-the-sdgs), 2018. dalam <https://www.unwomen.org/en/news/in-focus/women-and-the-sdgs>. UNDP. "Goal 5: Gender Equality" Website [undp.com](https://www.undp.org/content/seoul_policy_center/en/home/sustainable-development-goals/goal-5-gender-equality.html), 2018. https://www.undp.org/content/seoul_policy_center/en/home/sustainable-development-goals/goal-5-gender-equality.html. united nation. "SdG 5: Gender equality" Website [un.org](https://in.one.un.org/page/sustainable-development-goals/gender-equality-sdg-5/), 2017. <https://in.one.un.org/page/sustainable-development-goals/gender-equality-sdg-5/>.

Books

- 1) Ani Purwanti, Kekerasan Berbasis Gender. Yogyakarta, Bildung. 2020.
- 2) Bernard L.Tanya, et. al. Strategi Tertib Manusia Lintas Ruang dan Generasi. Yogyakarta, Genta Publishing, 2010.
- 3) Nasional, K. P. P. Bappenas. Ringkasan Metadata Indikator Tujuan Pembangunan Berkelanjutan (TPB). *Sustainable Development Goals (SDGs) Indonesia*. Jakarta. 2017.
- 4) Ife, J, Tesoriero. F. *Community development : community-based alternatives in on age of globalisation*. Australia. Pearson Education. 2001.
- 5) Johnson, A. G. *The gender knot: Unraveling our patriarchal legacy*. Temple University Press. Philadelphia. 2005.
- 6) Harari, Y. V. *Sapiens : a Brief History of Humankind*. New York. Harper. 2015.
- 7) Rahardjo, Satijpto. Ilmu Hukum. Bandung: P.T. Citra Aditya Bakti, 2000.
- 8) Soekanto, Soerjono. Sosiologi Suatu Pengantar. Jakarta: P.T RajaGrafindo Persada. 2002
- 9) Soedikno Mertokusumo, Mengenal Hukum. Yogyakarta, Atmajaya Publisher, 1999.

Regulations

- 1) The 1945 Constitution
- 2) The Criminal Code (KUHP)
- 3) Law Number 7 of 1984
- 4) Convention on the Elimination of All Forms of Discrimination against Women



There is an Open Access article, distributed under the term of the Creative Commons Attribution – Non Commercial 4.0 International (CC BY-NC 4.0) (<https://creativecommons.org/licenses/by-nc/4.0/>), which permits remixing, adapting and building upon the work for non-commercial use, provided the original work is properly cited.

Interaction between Training Methods and Eye-Foot Coordination on Football Passing Ability



Maulana Rahmawanto¹, Muchsin Doewes², Hanik Liskustyawati³, Slamet Riyadi⁴

^{1,2,3,4} Faculty of Sports, Universitas Sebelas Maret

ABSTRACT: This research aims to determine the differences in the influence of the El Rondo and Diamond Passing Drill training methods on female players' soccer passing abilities. This research uses experimental methods. Research design is a plan for conducting research, which helps research in collecting and analyzing data. The research design used in this research is 2 x 2 factorial. In order to find out differences in the results of the treatment given using control variables. This research was conducted at the Baturan Football Field, Kec. Colomadu, Kab. Karanganyar, Central Java. The test results with 2-way ANOVA statistics obtained in the interaction test obtained a calculated f value of 7.157 and a probability of 0.017. Based on the criteria mentioned above, probability < 0.05 means that interaction factors influence increasing football passing ability. interaction factors mean that training methods and eye-foot coordination work together to improve football passing ability. So Hypothesis 3 which states: there is an interaction between training methods and eye-foot coordination on increasing football passing ability is accepted. The conclusion of this study is an interaction effect between training methods and eye-foot coordination on increasing football passing ability as proven by the ANOVA statistical test, namely the probability value is 0.017 < 0.05.

KEYWORDS: Training methods, Foot-eye coordination, passing ability

INTRODUCTION

Football is a team sport, where each team consists of eleven players, and one of them is a goalkeeper (Anwar et al., 2013). The sport of football is the most popular activity among all groups and is the most popular in the world (Maliki et al., 2017). The development and progress of the sport of football over time has experienced significant rapid and better improvement in all countries in the world, both among parents, adults, teenagers and children, even men and women. Football can be used as an entertaining game and recreational activity, then it has developed widely as a means of maintaining physical fitness, has become a professional work profession, achieved high achievements, and can bring a good name to the region, nation and state (Pamungkas, 2021).

Football is a very popular and popular sport in Indonesia and throughout the world. The development and progress of the sport of football over time has experienced significant and rapid improvement in all countries of the world, both among parents, adults, teenagers and children, even men and women (Wibowo et al., 2019). Therefore, in general female footballers like this sport. To increase motivation, it is necessary to carry out exercises that contain a high content of fun and teamwork, as well as providing challenges for the players. The attraction of football is the skill of demonstrating the ability to handle the ball, a performance full of struggle, dynamic movements, accompanied by tactical surprises that make the audience amazed to see it (Wahyudi et al., 2016). Players' fluid and controlled movements express their individuality in team play. Speed, strength, stamina, skill and knowledge of tactics are all important aspects of performance (Pambudi et al., 2023).

Practice is an organized and deliberate series of game actions completed over a long period of time, meaning training physical, special, strategic and mental abilities to help competitors make the most extreme game progress (Putra, 2021). The expected achievement can be achieved if the athlete's physical condition improves thanks to a program designed by a coach (Firdaus Soffan Hadi, 2016). Training programs must be designed appropriately and systematically and directed at increasing the ability and functional capacity of the body system, so that athletes can achieve the best possible peak performance (Rizki Hazazi Ali et al., 2023).

A training method is a pattern, a simulation of a real condition that is composed of specific elements from a number of phenomena that are monitored and studied by someone from actual real examples (the same as describing the atmosphere of a

Interaction between Training Methods and Eye-Foot Coordination on Football Passing Ability

match). A training method must of course be in accordance with training that is identical in form to the characteristics of a real match (Almy & Sukadiyanto, 2014).

In general, coordination is defined as cooperation and procedures or something different and physiologically, coordination is defined as cooperation between the central nervous system and muscles to produce energy, both inter and intramuscular (Sakti, 2017). In a broad sense, coordination refers to the term or name for several abilities that support the cooperation of different movement processes, for example in learning coordination is divided into basic coordination (the ability to learn movements) and stable fine coordination (the ability to change and adapt movements). Coordination is a very complex biomotor ability, related to accuracy, speed, strength, endurance and flexibility. Apart from that, it is also included in the combination of behavior of two or more joints, which are related to each other in producing a movement skill (SUDARSONO, 2015).

This ability is intended to control parts of the body that are freely involved in a complex movement method, and combine these parts in a movement, a movement that is smooth and successful in achieving a goal. (Irwanto & Romas, 2019). Thus, coordination is the quality of muscles, bones and joints including the five senses in producing movement. Coordination ability is an actualization of movement components that work simultaneously (Iwandana et al., 2022). Because the movement components in question include, among other things, the energy system, muscle contraction, bone nerves, joints and eye senses, apart from that, combining the functions of several muscles appropriately and in balance into one good coordinated movement pattern will be able to combine several movements without tension. in the correct sequence and perform complex movements smoothly without expending excessive energy.

RESEARCH METHODS

This research uses experimental methods. Research design is a plan for conducting research, which helps research in collecting and analyzing data. The research design used in this research is 2 x 2 factorial. In order to find out differences in the results of the treatment given using control variables. This research was conducted at the Baturan Football Field, Kec. Colomadu, Kab. Karanganyar, Central Java.

2x2 Factorial Research Design Framework Table

Eye-Foot Coordination (a)	Practice Method	
	<i>El Rondo</i> (b1)	<i>Diamond Passing Drill</i> (b2)
High (a1)	a1b1	a1b2
Low (a2)	a2b1	a2b2
Football Passing Ability		

Information :

a1 : Players who have high eye-foot coordination

a2 : Players who have low eye-foot coordination

b1: Games Training Method (El Rondo)

b2 : Drill Training Method (Diamond Pass Drill)

a1b1: Treatment with game training methods for players who have a high level of eye-foot coordination

a2b1: Treatment with game training methods for players who have a low level of eye-foot coordination

a1b2 : Treat with the drill training method for players who have a high level of eye-foot coordination

a2b2: Treat with the drill training method for players who have a low level of eye-foot coordination.

RESULTS AND DISCUSSION

Description based on a combination of training methods and eye-foot coordination

Table 1. Descriptive statistics combination of training methods and eye-foot coordination

Observation	Stage	N	Minimum	Maximum	Mean	Std. Deviation
ER KMK low	Pretes	8	3	6	4,5	0,926
	Postes	8	7	9	7,75	0,707
	Difference	8	2	5	3,25	1,035
DPD KMK low	Pretes	12	3	7	5	1,279

Interaction between Training Methods and Eye-Foot Coordination on Football Passing Ability

	Postes	12	5	9	7,0833	1,240
	Difference	12	1	4	2,0833	0,900
ER KMK low	Pretes	8	5	6	5,625	0,518
	Postes	8	6	8	6,875	0,835
	Difference	8	0	2	1,25	0,707
DPD KMK high	Pretes	5	4	7	5,8	1,095
	Postes	5	7	8	7,8	0,447
	Difference	5	1	3	2	0,707

The results of the descriptive statistical tests in the table above show that the average pretest score for El Rondo's football passing ability with low ankle coordination is 4.5 with a standard deviation value of 0.926. The minimum pretest score for El Rondo's football passing ability with low eye-foot coordination is 3 and the maximum score is 6.

The results of the descriptive statistical tests in the table above show that the average post-test score for El Rondo's football passing ability with low ankle coordination is 7.75 with a standard deviation value of 0.707. The minimum post-test score for El Rondo's football passing ability for low eye-foot coordination is 7 and the maximum score is 9.

The results of descriptive statistical tests in the table above show that the average value of the difference in El Rondo's football passing ability with low ankle coordination is 3.25 with a standard deviation value of 1.035. The minimum value of the difference in El Rondo's football passing ability with low ankle coordination is 2 and the maximum value is 5.

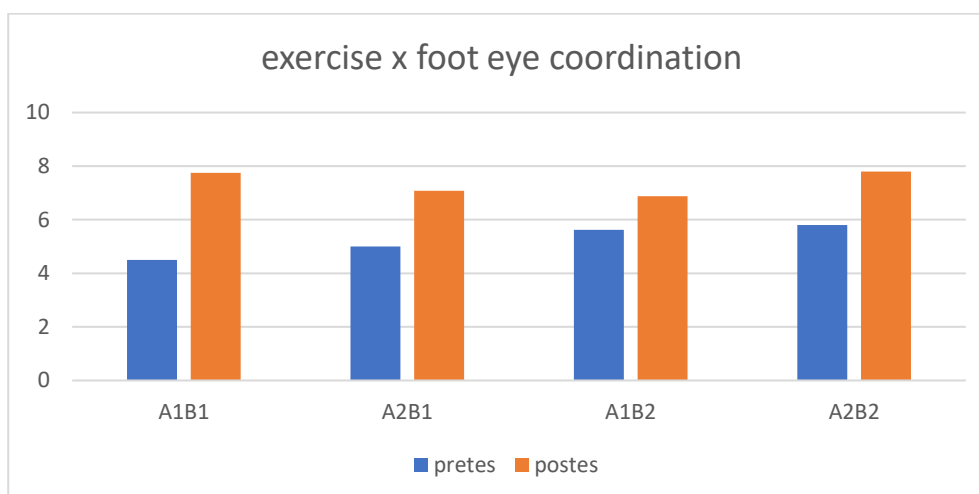

Chart 1. Combination of training methods and eye-foot coordination

In the picture above it can be seen that the four groups of combinations of training methods and eye-foot coordination resulted in good improvements in El Rondo with low eye-eye coordination (A1B1), Diamond Passing Drill with low eye-eye coordination (A2B1), El Rondo with high eye-eye coordination (A1B2), as well as the Diamond Passing Drill with high eye toe coordination (A2B2). respectively, the increases from largest to smallest are El Rondo low ankle coordination (A1B1), Diamond Passing Drill low ankle coordination (A2B1), Diamond Passing Drill high ankle coordination (A2B2), and El Rondo high ankle coordination (A1B2) namely 3.25; 2.0833; 2; and 1.25. To ensure whether the increase is significant, statistical tests need to be carried out which will be explained in a separate discussion.

The test results with 2-way ANOVA statistics obtained in the interaction test obtained a calculated f value of 7.157 and a probability of 0.017. Based on the criteria mentioned above, probability < 0.05 means that interaction factors influence increasing football passing ability. interaction factors mean that training methods and eye-foot coordination work together to improve football passing ability. So Hypothesis 3 which states: there is an interaction between training methods and eye-foot coordination on increasing football passing ability is accepted.

CONCLUSION

The conclusion of this study is an interaction effect between training methods and eye-foot coordination on increasing football passing ability as proven by the ANOVA statistical test, namely the probability value is $0.017 < 0.05$.

Interaction between Training Methods and Eye-Foot Coordination on Football Passing Ability

REFERENCES

- 1) Almy, Muh. A., & Sukadiyanto, S. (2014). Perbedaan Pengaruh Circuit Training Dan Fartlek Training Terhadap Peningkatan Vo2Max Dan Indeks Massa Tubuh. *Jurnal Keolahragaan*, 2(1), 59–68. <https://doi.org/10.21831/jk.v2i1.2603>
- 2) Anwar, S., Pendidikan, J., Kesehatan, J., & Keolahragaan, F. I. (2013). *Survei Teknik Dasar Dan Kondisi Fisik Pada Siswa Sekolah Sepak Bola (Ssb) Se Kabupaten Demak Tahun 2012*. 2(9), 596–604.
- 3) Firdaus Soffan Hadi, Dkk. (2016). Pengaruh Latihan Ladder Drills Terhadap Peningkatan Kelincahan Siswa U-17 Di Persatuan Sepakbola Jajag Kabupaten Banyuwangi. *Jurnal Pendidikan Jasmani*, 26(1), 213–228.
- 4) Irwanto, & Romas, M. Z. (2019). Profil Peran Psikologi Olahraga Dalam Meningkatkan Prestasi Atlet di Serang-Banten Menuju Jawara. *Prosiding Seminar Nasional IPTEK Olahraga*, 2(1), 1–14.
- 5) Iwandana, D. T., Falaahudin, A., & Romadhoni, M. (2022). Koordinasi Kegiatan Menjaga Kebugaran Melalui Massage Bagi Atlit KONI Bantul Yogyakarta. *Seminar Nasional Hasil Riset Dan Pengabdian*, 28(6), 1426–1429.
- 6) Maliki, O., Hadi, H., & Royana, I. F. (2017). Analisis Kondisi Fisik Pemain Sepakbola Klub PERSEPU UPGRIS Tahun 2016. *Jendela Olahraga*, 2(2), 1–8.
- 7) Pambudi, T., Mukarromah, S. B., Rahayu, S., & Iwandana, D. T. (2023). Efektivitas Aplikasi Data Base Kondisi Fisik Atlet Bulu Tangkis Berbasis Android. *Gelombang Olahraga: Jurnal Pendidikan Jasmani Dan Olahraga (JPJO)*, 6(2). <https://doi.org/10.31539/jpjo.v6i2.6170>
- 8) Pamungkas, O. I. (2021). Hubungan Fleksibilitas dan Kekuatan Terhadap Kemampuan Tendangan Dollyo Chagi Atlet Taekwondo Universitas Negeri Yogyakarta. *Jorpres (Jurnal Olahraga Prestasi)*, 17(2), 142–147.
- 9) Putra, M. B. R. (2021). Pengaruh Latihan Drill Passing Dan Ball Feeling Terhadap Keterampilan Sepak Bola Ditinjau Dari Koordinasi Mata-Kaki Peserta Didik Ekstrakurikuler Smp N 3 Godean. *NBER Working Papers*, 89.
- 10) Rizki Hazazi Ali, Witri Suwanto, & Dody Tri Iwandana. (2023). Kombinasi Latihan Aerobik dan Konsumsi Kunyit dapat Meningkatkan VO2Max Mahasiswa. *SPRINTER: Jurnal Ilmu Olahraga*, 4(1). <https://doi.org/10.46838/spr.v4i1.297>
- 11) Sakti, B. P. I. (2017). Hubungan koordinasi mata-kaki dan kelincahan dengan keterampilan menggiring bola dalam permainan sepakbola pada siswa ekstrakurikuler SMA Negeri 2 Lubuklinggau. *Biomatika : Jurnal Ilmiah Fakultas Keguruan Dan Ilmu Pendidikan*, 3(2), 1–7.
- 12) Sudarsono, S. (2015). Penyusunan Program Pelatihan Berbeban Untuk Meningkatkan Kekuatan. *Ilmiah SPIRIT*, 12(1), 31–43.
- 13) Wahyudi, W., Hariyoko, H., & Amiq, F. (2016). Pengaruh Latihan Pliometrik Barrier Hops Dengan Latihan Komando Terhadap Peningkatan Prestasi Shooting SSB Indonesia Muda Kota Malang. *Pendidikan Jasmani*, 26(2), 244–256.
- 14) Wibowo, A. T., Syafitri, A., & Iwandana, D. T. (2019). Psychological Characteristics of PSIM Yogyakarta Players in Wading the League 2 Soccer Competition in 2019/2020. *Quality in Sport*, 9(11), 217–225. <https://doi.org/10.12775/qs.2019.018>

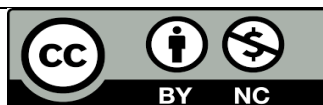

There is an Open Access article, distributed under the term of the Creative Commons Attribution – Non Commercial 4.0 International (CC BY-NC 4.0) (<https://creativecommons.org/licenses/by-nc/4.0/>), which permits remixing, adapting and building upon the work for non-commercial use, provided the original work is properly cited.

Online Dispute Resolution (ODR): Pillar of a Modern and Inclusive Judicial System in Indonesia



Ardina Nur Amalia¹, Muhammad Ramdan²

^{1,2}Faculty of Law, Universitas Diponegoro, Jl. dr. Antonius Suroyo, Tembalang, Semarang, Indonesia

ABSTRACT: Many facets of society, including the legal profession, have been profoundly impacted by the development of information and communication technology. A quick and effective resolution process is required in Indonesia due to the growing number of legal disputes. According to Article 1(10) of Law No. 30 of 1999 on Arbitration and Alternative Dispute Resolution, the rise of Alternative Dispute Resolution (ADR) provides non-litigation methods such as mediation, negotiation, and arbitration, even though traditional litigation is still a last resort. As technology advanced, alternative dispute resolution (ADR) gave way to online dispute resolution (ODR), which combines digital platforms and the internet to provide distant and economical dispute resolution procedures.

This study looks at how ODR helps Indonesia develop a contemporary, inclusive legal system. It emphasizes how ODR may be used to resolve issues like case.

KEYWORDS: Online Dispute Resolution, Inclusivity, Modern Justice System, Digital Transformation, Implementation ODR

I. INTRODUCTION

The advancement of information and communication technology brings about significant changes in many areas of life, including the legal profession. Because Indonesia has so many legal conflicts, it is critical to take prompt and accurate action to resolve them. Essentially, the fundamental concept of law is that it should be used as an *ultimum remedium*, or as a last option, if other attempts to address an issue fail. This phenomena introduces new obstacles to dispute settlement, resulting in the establishment of non-legal dispute resolution techniques known as Alternative Dispute settlement (ADR). Article 1, paragraph 10 of Law Number 30 of 1999 concerning Arbitration and Alternative Dispute Resolution says that ADR is an institution for settling conflicts outside of the court, with processes agreed upon by both parties through measures such as consultation.

During the development of ADR, the method of resolving disputes in the form of Online Dispute Resolution (ODR) was introduced, which is an alternative method of resolving disputes that uses electronic media and internet networks in the process, hence reducing physical expenses. When compared to traditional litigation, ODR provides faster, easier, and less expensive solutions because it is conducted online, eliminating the need for clients to travel to court because the process can take place anywhere and at any time.

The use of ODR is a method of modernizing the legal system in the digital age. The advancement of technology now allows ADR to be carried out in a more efficient manner. For example, major countries such as the United States and Europe have adapted to ODR as a means of addressing problems in the real world (cybercrime), allowing ODR to become one of the primary methods of.

It cannot be denied that the Indonesian legal system is heavily influenced by traditional dispute enforcement methods. There has been a shift in the Indonesian population's willingness to adapt to digital media, which is due to a variety of factors, the most notable of which being a lack of literacy and technological infrastructure in various areas. If you have been confronted with a difficult situation, both the public and the government must seek a quick and effective solution to the problem at hand. The use of ODR in Indonesia is becoming increasingly popular, particularly in electronic transactions and e-commerce. Numerous platforms offering ODR systems have emerged, including Badan Arbitrase Nasional Indonesia (BANI) online, Mahkamah Agung RI, and Lembaga Alternatif Penyelesaian Sengketa Online (LAPSO).

The demand for effective and efficient dispute management is increasing every day. With various advantages, using internet media has its own set of benefits. ODR has become an important necessity for those who wish to choose this path due to its various benefits and ease of use. ODR monitors all alternative dispute cases outside of court proceedings combined with

Online Dispute Resolution (ODR): Pillar of a Modern and Inclusive Judicial System in Indonesia

technology and the internet. The most common alternative dispute resolution (ADR) processes, such as mediation and arbitration, are based on a dispute resolution process that involves three parties, two of whom are the disputing parties and the third is a neutral party. Furthermore, ODR empowers the weaker party, which is technology. People in positions of authority can use ODR to manage their operations.

ODR introduces a new concept of dispute management using digital media and space.

Regarding the modern era of globalization and digitization, which fuels the rise of several new dispute types, particularly in e-commerce transactions and cross-border commercial partnerships, ODR is extremely pertinent. In order to avoid interfering with corporate operations, many disagreements that arise in online transactions frequently call for prompt and workable solutions. Given its adaptable procedure and accessibility from multiple locations, ODR may be the best option in this case due to its lack of geographical restrictions. ODR is a crucial first step toward a judiciary that is more flexible and adaptable to the times, as these developments have made the need for modernization in Indonesia's legal system more pressing. The possibility of integrating ODR into Indonesia's contemporary legal system is becoming more and more pertinent.

A high volume of cases, overlapping administration, and restricted access to courts in rural locations are just a few of the issues that the Indonesian legal system continues to face. Due to these restrictions, the court system is overburdened, which frequently prevents the public from receiving prompt and effective conflict remedies. ODR makes it possible to perform the dispute resolution process online, which eliminates the need for in-person meetings, expedites the process, and saves the disputing parties money. Author will talk about the opportunities and problems of implementing ODR in Indonesia, as well as its role in achieving a contemporary and inclusive legal system, based on how the problem was formulated.

II. RESEARCH METHODS

In order to investigate several laws and legal documents pertinent to the implementation of Online Dispute Resolution (ODR) in Indonesia, the normative juridical technique was employed as the research method in this study. The methods employed include the statutory approach, which looks at the legal underpinnings of laws like PERMA No. 1 of 2019 on Electronic Case Administration and Law No. 19 of 2016 on Electronic Information and Transactions. Additionally, as one of the cornerstones of the contemporary legal system, ODR's concepts and principles are understood through a conceptual approach. The secondary data used in this study came from academic journals, legal literature, and earlier research reports. Descriptive qualitative analysis was used to examine and analyze the data in order to produce comprehensive analysis of ODR's prospects, difficulties, and implementation tactics in Indonesia. In order to derive pertinent lessons for the Indonesian context, this study also compares ODR procedures in other nations.

III. RESULTS AND DISCUSSION

A. The Role of Online Dispute Resolution (ODR) in Realizing a Modern and Inclusive Justice System in Indonesia

Online Dispute Resolution (ODR) plays a strategic role in building a modern and inclusive justice system in Indonesia. By utilizing information technology, ODR is able to overcome various barriers to access to justice, such as geographical constraints, high costs, and complex bureaucracy. ODR allows the community, especially those in remote areas or with mobility limitations, to access dispute resolution without having to go to court. This supports the principle of simple, fast, and low-cost justice as mandated in Article 2 paragraph (4) of Law No. 48 of 2009 on Judicial Power.

A more efficient process is one of the advantages of ODR compared to conventional courts. By using an online platform, the time to resolve disputes can be significantly reduced, thereby helping to reduce the backlog of cases in court.² In addition, ODR creates inclusivity by providing broader access to vulnerable groups and low-income communities through more affordable costs and simpler procedures.³ This initiative is also in line with efforts to modernize the judicial system in Indonesia, which have already begun with the digitization through e-Court and e-Litigation by the Supreme Court.

ODR supports the resolution of disputes arising from increasingly prevalent digital transactions, such as e-commerce and online services. By providing technology-based solutions, ODR is not only relevant to the needs of the modern economy but also enhances public trust in the justice system through transparent, swift, and accountable processes.⁶ The implementation of ODR in Indonesia also opens up opportunities for collaboration between the government and the private sector, such as technology companies and online legal service providers, to create innovative platforms that meet societal needs.⁷ However, the successful implementation of ODR requires adequate technological infrastructure support, clear regulations, and training for legal human resources to adapt to digital dispute resolution mechanisms. The use of blockchain technology is also being considered to create a more secure and transparent system in the ODR process. Additionally, training for mediators, arbitrators, and judges to adapt to digital technology will be an important step in strengthening the implementation of ODR in Indonesia.

Online Dispute Resolution (ODR): Pillar of a Modern and Inclusive Judicial System in Indonesia

Although still in its early stages, the implementation of ODR in Indonesia has shown significant progress with the introduction of the e-court platform by the Supreme Court. The e-court application is an electronic case administration system introduced in 2018 through Supreme Court Regulation (Perma) Number 3 of 2018 on Electronic Case Administration in Courts, and later reinforced by Perma Number 1 of 2019, which allows for the implementation of electronic trials or e-litigation. e-Court and e-Litigation provide greater flexibility for parties involved in civil disputes, especially during the COVID-19 pandemic era, when mobility is limited and physical meetings are high-risk.

Through e-litigation, parties can submit evidence and responses digitally, attend virtual hearings, and conduct electronic proofing. The district courts in various regions of Indonesia have begun to utilize this platform for civil cases, religious civil cases, administrative cases, and other cases that allow for virtual resolution. e-Court and e-Litigation provide greater flexibility for parties involved in civil disputes, especially during the COVID-19 pandemic era, when mobility is limited and physical meetings are high-risk. Through e-litigation, parties can submit evidence and responses digitally, attend virtual hearings, and conduct electronic proof. District courts in various regions of Indonesia have begun to utilize this platform for civil cases, religious civil cases, administrative cases, and other cases that allow for virtual resolution.

Online Dispute Resolution is critical to Indonesia's transition to a more inclusive modern court system. ODR uses information technology to address structural and procedural hurdles that prevent the community from accessing justice. Some of the primary tasks of ODR in achieving a contemporary and inclusive judicial system:

1. Improving Community Accessibility.

The use of ODR in Indonesia enables communities in rural places or with limited mobility to resolve disputes without having to physically attend court. The online ODR system eliminates geographical obstacles, lowers travel costs, and saves time for both parties. In Indonesia, because there are still constraints in physical infrastructure and technology, ODR serves as Bridge to achieve more equitable justice.

2. Efficient Dispute Resolution Process

In comparison to traditional court processes, ODR provides a speedier way to resolve disputes. Using an automated system and basic procedures, the time required to resolve conflicts can be greatly reduced. This efficiency benefits both the contesting parties and the court by reducing the case backlog.

3. Enhancing the Principle of Inclusivity in Justice.

ODR makes room for marginalized communities in the court system, such as vulnerable groups and low-income people. With cheaper prices and more flexible processes, ODR allows everyone to get a fair dispute settlement.

4. ODR supports the digitalization and modernization of the judiciary in Indonesia.

Digital initiatives like e-Court and e-Litigation help to facilitate this. ODR strengthens digitization by providing full dispute resolution through technology access, ranging from mediation to decision-making. ODR not only improves efficiency, but it also increases the judicial system's transparency and accountability.

5. Building public trust in the justice system.

ODR delivers a more accessible, speedier, and transparent approach that is supposed to boost public trust in the legal system. Trust is essential for ensuring the advancement of judicial reform and developing a culture of more effective dispute settlement.

6. Adaptation to the development of digital transactions.

As technology advances, more and more disputes arise over online transactions such as e-commerce, digital services, and intellectual property rights. ODR is particularly useful for resolving disputes originating from digital internet transactions.

7. Promoting Multisector Collaboration

ODR allows the government to work with the private sector, including technology businesses and online legal service providers, to create an innovative ODR platform. This collaboration speeds up the implementation of ODR and develops solutions that fulfill the demands of Indonesian citizens. ODR has emerged as an important component in the development of a modern justice system that is both inclusive and efficient. To transform the paradigm of traditional conflict resolution, ODR implementation must be supported by proper technology infrastructure, robust rules, socialization, and education for the larger society.

B. Challenges and Opportunity of ODR Implementation in Indonesia

In order to make Online Dispute Resolution (ODR) a service that is both efficient and available to the general public, Indonesia must overcome a number of barriers and difficulties. Some parts of Indonesia have limited access and technological infrastructure, which makes it difficult for residents to successfully use ODR services. This is particularly true in distant locations where internet connectivity is still scarce. Particularly when ODR necessitates a steady connection for online court hearings, digital document distribution, and video communication, this disparate technology infrastructure presents a serious challenge. In terms of

Online Dispute Resolution (ODR): Pillar of a Modern and Inclusive Judicial System in Indonesia

regulations, ODR is still not widely regulated in Indonesia, despite the Supreme Court Regulation (PERMA) No. 1 of 2019 including rules pertaining to mediation.

Neither ODR methods nor operational standards for digital dispute resolution platforms are explicitly covered by the current legislative regulations. Another issue is the absence of established protocols for party permission and the legal validity of digital agreements in ODR, which frequently causes administrative and bureaucratic obstacles in their execution. ODR involves the transmission and storage of important personal data, including case documents, party arguments, and the decisions reached. The risk of cyber security breaches and data privacy is a major concern in ODR because it can threaten the integrity of the process and public trust. Cases of hacking, data theft, or misuse of information conveyed in the ODR process can have fatal consequences and hinder public trust in using this service.

Another challenge faced from the community's side is that many people still lack adequate digital literacy to use the ODR platform. The community is not familiar with how to use digital technology for dispute resolution, which can make the ODR process inefficient or even fail. In addition, mediators, arbitrators, and other legal professionals also need adequate training to become accustomed to using technology in the dispute resolution process, so that ODR can be implemented to its fullest potential.

Face-to-face conflict resolution is still preferred by many parties over online dispute resolution. Particularly in the context of Indonesian culture, which values direct communication and familial ways, online dispute resolution is seen as less private, which lowers the degree of trust in the results obtained. To increase public awareness of ODR's benefits and increase its acceptance as a valid and practical conflict resolution option, campaigns and education are required. Comprehensive legislation that can accommodate a number of significant components of the online dispute resolution process are required in order to facilitate the successful implementation of Online Dispute Resolution (ODR) in Indonesia. In addition, ODR regulations must adhere to strict standards for confidentiality in order to protect sensitive information and private data belonging to the parties involved in the case.

Given the significant risk of cyberattacks and data breaches in online procedures, which can injure the parties and erode public confidence in ODR as a secure dispute resolution method, this is crucial. Because the evidence and documents provided in ODR will be in electronic form, rules governing the recognition of digital documents and electronic evidence must also be reinforced. Decisions taken in the ODR forum will be able to be recognized and upheld in courts and other relevant institutions thanks to the legal recognition of digital evidence.

Harmonization with international standards must also be taken into account while drafting rules, especially in light of the growing number of cross-border conflicts in the age of globalization and economic digitization. For instance, Indonesia can adopt internationally recognized best practices in online dispute resolution by implementing the principles outlined in UNCITRAL's technical notes on ODR. This will make it easier for Indonesian ODR decisions to be recognized and, if needed, enforced in other nations. In addition to technical legislation, the government must construct equitable and sufficient technology infrastructure across Indonesia to support the implementation of ODR, particularly in rural areas with restricted internet access. In order for ODR to be accessible to all societal strata and not just urban ones, it is crucial to have an equal infrastructure. This will enable the principle of justice to be realized more broadly.

To ensure that all parties can comprehend and utilize ODR efficiently, assistance in the form of digital literacy training is also required for the community, court officials, advocates, and mediators. In order to reduce mistakes or system misuse and guarantee that the ODR process operates efficiently and in compliance with relevant legal regulations, this is crucial. With a thorough legal framework, sufficient infrastructure, and extensive instruction in digital literacy, Indonesia may establish ODR as a dispute resolution process that is not only effective but also secure, dependable, and available to all societal groups. In the rapidly changing digital economy era, where cross-border conflicts and online transactions are growing more frequent, this will improve Indonesia's standing.

The adoption of Online Dispute Resolution (ODR) in Indonesia is still in the works, but some first steps have been taken through the Supreme Court's initiative to modernize the legal system. One of the most noteworthy accomplishments is the introduction of the e-Court and e-Litigation platforms, which enable case submission, court fee payment, and online hearings. However, complete implementation of ODR, particularly for out-of-court conflict resolution processes such as mediation and arbitration, has yet to be fully realized. However, ODR's ability to overcome geographical and regulatory constraints is particularly pertinent to Indonesia's vast and diverse geographical conditions.

One of the legal basis for ODR adoption is PERMA No. 1 of 2019 on Electronic Case Administration in Courts. This regulation lays the groundwork for technology-based legal administration processes, but it is presently limited to court-related litigation. To fully enable ODR, additional regulation development is required to incorporate alternative dispute resolution (ADR) methods such as online mediation and arbitration. This is necessary to ensure legal certainty in the implementation of ODR, including legislation governing data protection, mediation procedures, and the recognition of online dispute resolution conclusions.

Online Dispute Resolution (ODR): Pillar of a Modern and Inclusive Judicial System in Indonesia

To fully enable ODR, additional regulation development is required to incorporate alternative dispute resolution (ADR) methods such as online mediation and arbitration. This is necessary to ensure legal certainty in the implementation of ODR, including legislation governing data protection, mediation procedures, and the recognition of online dispute resolution conclusions.

The adoption of Online Dispute Resolution (ODR) in Indonesia is still in the works, but some first steps have been taken through the Supreme Court's initiative to modernize the legal system. One of the most noteworthy accomplishments is the introduction of the e-Court and e-Litigation platforms, which enable case submission, court fee payment, and online hearings. However, complete implementation of ODR, particularly for out-of-court conflict resolution processes such as mediation and arbitration, has yet to be fully realized. However, ODR's ability to overcome geographical and regulatory constraints is particularly pertinent to Indonesia's vast and diverse geographical conditions.

One of the legislative basis to support the deployment of ODR is PERMA No. 1 of 2019 about Electronic Case Administration in Courts. is regulation provides the groundwork for technology-based legal administration processes, but it is presently limited to court-related litigation. To fully promote ODR, additional regulation development is required to incorporate alternative dispute resolution (ADR) methods such as online mediation and arbitration. This is necessary to ensure legal certainty in the implementation of ODR, including legislation governing data protection, mediation procedures, and the recognition of online dispute resolution conclusions.

The usage of ODR in Indonesia confronts a number of hurdles, including uneven technological infrastructure and considerable digital gaps. According to data from the Ministry of Communication and Information, over 20% of Indonesia's areas still have inadequate internet connectivity, which can impede ODR inclusion. Moreover, the lack of digital literacy among the optimization of ODR implementation presents a problem for public and legal practitioners alike. Some judges, lawyers, and mediators do not completely understand the technology utilized in ODR, necessitating extensive training to facilitate its use.

Nonetheless, the application of ODR can give enormous benefits to Indonesian society. By utilizing technology, ODR can lower the time and expense of dispute resolution while also providing greater access to groups in society that have hitherto struggled to reach the courts. ODR can also be used to resolve disputes resulting from the expanding number of digital transactions, including e-commerce, finance, and application-based services. This makes ODR useful for meeting legal needs in the digital age and promoting technology-based economic growth.

To speed up the introduction of ODR, Collaboration among the government, commercial sector, and academia is required. The government may speed up the construction of digital infrastructure and implement rules that promote ODR, while the private sector can help by providing secure and user-friendly technology platforms. Academics can also help develop policy recommendations and provide training to legal practitioners. With these initiatives, ODR has the potential to become a key component of Indonesia's contemporary and inclusive justice system.

IV. CONCLUSIONS

A step toward adjusting the dispute resolution procedure to technology developments and the public's need for a quicker, more effective, and more economical process is the introduction of Online Dispute Resolution (ODR) into the Indonesian legal system. Online dispute resolution (ODR) encompasses mediation, arbitration, or digital platform negotiation from the point of contact to the ultimate conclusion. One of the many challenges facing online dispute resolution (ODR) in Indonesia is the lack of adequate technology in rural areas, which makes it difficult for the general public to utilize these services. Although mediation is governed by PERMA No. 1 of 2019, there are still few explicit ODR legislation, particularly when it comes to operational processes and requirements for legally binding digital agreements. Given that the possibility of information leaks might compromise the integrity of the ODR process and erode public confidence, cybersecurity and data privacy provide additional challenges.

Low digital literacy, cybersecurity threats, cultural preferences for direct dispute resolution, and a lack of technology infrastructure are some of the obstacles to Indonesia's adoption of online dispute resolution (ODR). Comprehensive laws are required to solve these problems, including cybersecurity standards, harmonization with international standards, and the legal recognition of electronic evidence. To increase public confidence in ODR as a secure, inclusive, and efficient dispute resolution process, the government must also upgrade its IT infrastructure, train people in digital literacy, and educate the general public.

REFERENCES

- 1) Amiruddin, & Asikin, Z. (2006). *Pengantar metode penelitian hukum*. Jakarta: Raja Grafindo Persada.
- 2) Ashshofa, B. (2013). *Metode Penelitian Hukum*. Jakarta: Rineka Cipta.
- 3) Budiarto, M. (2022). *Tantangan dan Peuang Implementasi ODR dalam Sistem Peradilan Indonesia*. Jakarta: Pustaka Hukum.
- 4) Hajati, S., dkk. (2018). *Politik hukum pertanahan*. Yogyakarta: Airlangga University Press.

Online Dispute Resolution (ODR): Pillar of a Modern and Inclusive Judicial System in Indonesia

- 5) Katsh, E., & Rifkin, J. (2001). *Online Dispute Resolution: Resolving conflicts in cyberspace*. San Francisco: Jossey-Bass.
- 6) Kusuma, A. (2021). *ODR dan penyelesaian sengketa e-commerce di Indonesia*. Bandung: Litera Hukum.
- 7) Mertokusumo, S. (2016). *Penemuan hukum: Sebuah pengantar*. Yogyakarta: Liberty.
- 8) Soekanto, S., & Mamuji, S. (2013). *Penelitian Hukum Normatif: Suatu Tinjauan Singkat*. Jakarta: Raja Grafindo Persada.
- 9) Sutiyoso, B. (2004). *Penyelesaian sengketa bisnis*. Jakarta: Rajawali.
- 10) Widjaja, G. (2004). *Alternatif penyelesaian sengketa*. Jakarta: PT Raja Grafindo.
- 11) Adel, C. (2004). Penyelesaian sengketa transaksi elektronik melalui Online Dispute Resolution (ODR) kaitan dengan UU Informasi dan Transaksi Elektronik Nomor 11 Tahun 2008. *Jurnal Ilmu Komputer*, 10(2).
- 12) Petrauskas, F., & Kbartiene, E. (2011). Online Dispute Resolution in consumer disputes. *Jurisprudencia, Mykolas Romeris University*.
- 13) Prasetya, F., & Siregar, T. (2023). Keamanan data dalam proses penyelesaian sengketa online. *Jurnal Keamanan Digital*, 5(1), 33-50.
- 14) Prasetyo, S., & Kurniawan, R. (2023). Efektivitas Online Dispute Resolution dalam penyelesaian sengketa konsumen. *Jurnal Hukum Ekonomi*, 5(1), 44-60.
- 15) Rainey, D. (2019). Online Dispute Resolution: Challenges for contemporary justice systems. *International Journal of Law and Information Technology*, 27(4), 303-329.
- 16) Setyawan, R. (2024). Blockchain sebagai teknologi pendukung ODR di Indonesia. *Seminar Nasional Teknologi Hukum*, Surabaya.
- 17) Wahyuni, D. (2022). Pengembangan Online Dispute Resolution di Indonesia. *Jurnal Hukum & Teknologi*, 3(2), 105-120.
- 18) Mahkamah Agung RI. (2016). *Peraturan Mahkamah Agung No. 1 Tahun 2016 tentang Prosedur Mediasi di Pengadilan*. Jakarta.
- 19) UNCITRAL. (2017). *Technical Notes on Online Dispute Resolution*. United Nations.
- 20) Undang-Undang Nomor 30 Tahun 1999 tentang Arbitrase dan Alternatif Penyelesaian Sengketa.
- 21) Undang-Undang Nomor 11 Tahun 2008 tentang Informasi dan Transaksi Elektronik.
- 22) Undang-Undang Nomor 27 Tahun 2022 tentang Perlindungan Data Pribadi.



There is an Open Access article, distributed under the term of the Creative Commons Attribution – Non Commercial 4.0 International (CC BY-NC 4.0)

(<https://creativecommons.org/licenses/by-nc/4.0/>), which permits remixing, adapting and building upon the work for non-commercial use, provided the original work is properly cited.

Measures: The New Face of Criminal Punishment in the New Indonesian Criminal Code



Feri Satria Wicaksana Effendy¹, Umaira Hayuning Anggayasti²

^{1,2}Faculty of Law, Universitas Diponegoro, Jl. dr. Antonius Suroyo, Tembalang, Semarang, Indonesia

ABSTRACT: The criminal punishment system in the WvS Criminal Code has shifted from only imposing punishments (single track system) to punishment and/or measures (double track system) in the National Criminal Code. This study aims to determine the conditions under which measures can be imposed and the form and application of measures in the new Criminal Code. The method used in this study is the doctrinal research method. The conditions for criminal law subjects to be subject to measures are as follows: if the criminal law subject is an individual, including people with mental and intellectual disabilities, children under 14 (fourteen) years of age, and corporations. The imposition of Measures must be based on the objectives and guidelines for punishment as in Articles 51 to 54 of the New Criminal Code.

KEYWORDS: Measures, Punishments, National Criminal Code

I. INTRODUCTION

Criminal law in Indonesia has undergone a long transformation along with the dynamics of the nation's history. Since the Dutch colonial era, our criminal justice system has continued to evolve, influenced by various factors such as social, political, and economic changes. The Criminal Code we know today results from accumulating these various influences.

In the early 20th century, the Dutch East Indies government felt the need to have consistent and systematic legal regulations regarding criminal acts. This was the background to the birth of the first Criminal Code in Indonesia in 1918, which underwent several revisions and changes over time. (Malau, 2023)

The renewal of the Criminal Code of a national nature began in 1963 through a First National Criminal Law Seminar at Diponegoro University, Semarang, in which the seminar stated the reasons for the importance of having a Criminal Code of a national nature in the sense that its spirit, soul and philosophy are all based on the foundation of Indonesian nationalism. (Setiadi, 2011)

Changes in legislation in Indonesia must create a more stable environment so that every citizen can enjoy an atmosphere and climate of order and legal certainty, with justice at its core. (Zainuddin, Mubarok, & Bachriani, 2022)

The Wetboek van Strafrecht, translated as the Criminal Code used to date, is considered unable to accommodate various problems and developments in new forms of criminal acts in line with the development and dynamics of society. This raises concerns, primarily related to the dogmatic nature and substance of the Criminal Code, which is thick with classical and Western schools which are considered to be incompatible with the Eastern culture adopted by Indonesian society, so we should reform Indonesian criminal law, which is based on fundamental values and socio-philosophical, socio-political and socio-cultural values that live in Indonesian society. (Fadhilah, Zulkarnain, Yulianto, & Satory, 2024)

Sentencing or imposing sanctions or punishments on defendants depends on the judge. Judges are not bound by the severity of the prosecutor's demands; judges can sentence defendants more severely or more lightly than the prosecutor's requisitor based on considerations of aggravating and mitigating factors for the defendant's actions. (Rivanie, Muchtar, Muin, Prasetya, & Rizky., 2022)

Legal norms are different from several other social norms that apply in society; norms of politeness, for example, do not have strict sanctions when violated, and the same happens to moral and religious norms. Unlike the three norms, legal norms have sanctions that are imperative in the form of physical coercion and are implemented by institutions appointed to implement them by the State. (Winda Apriani Zarona Harahap, Asep Syarifuddin, 2021)

Measures: The New Face of Criminal Punishment in the New Indonesian Criminal Code

The purpose of punishment essentially contains two main aspects, namely:

1. Aspect of protecting society against criminal acts.

This first central aspect includes the objectives: a) Crime prevention, b) Protection (security) of society, c) Restoring social balance: Conflict resolution (conflict oplosing) and Bringing a sense of peace (vredemaking)

2. Aspect of protection/guidance of individual perpetrators of criminal acts (aspect of criminal individualization)

This second central aspect can include the following objectives: First, rehabilitation, reduction, and resocialization (socializing) of convicts so they no longer repeat or commit acts damaging/harmful to themselves or others/society. Second, so that they have good morals (morals) of Pancasila. Freeing guilt and protecting the perpetrator from the imposition of arbitrary sanctions or inhumane retaliation (criminal punishment is not intended to suffer and degrade human dignity)

From the description, it can be concluded that if criminal law must be oriented towards protecting society to achieve social welfare, then a theory that only sees one aspect of the general goal is actually too one-sided. Therefore, a new, more humane criminal punishment system is needed to fulfil the purpose of punishment, so a new sanction system is formed, which is known as measures.

Sardjana Orba Manullang (Manullang, Tompul, Kusumadewi, Krisnalita, & Mutiarany, 2023) has conducted several studies. One focused on the binding power of the National Criminal Code to Special Laws, reviewed from a Philosophical Perspective. Muhammad Idris Nasution's (Nasution, Ali, & Lubis, 2024) other study discussed the renewal of the criminal punishment system but only focused on punishments. The method used in this study is doctrinal research.

The criminalization system in the WvS Criminal Code has shifted from only imposing punishments (single-track system) to punishments and/or measures (double-track system). This study aims to determine the conditions under which measures can be imposed and the forms and implementation of measures in the new Criminal Code.

II. DISCUSSION

Criminal acts are subject to punishment and/or measures by statutory regulations. The act must be unlawful or contrary to the laws that apply in society. Measures are new in the National Criminal Code compared to the WvS Criminal Code. In the WvS Criminal Code, there are indeed forms of measures, but they are not explicitly referred to as Measures.

Measures have been standardized in the National Criminal Code as one form of sanction accompanying punishment. To find out more, we will discuss the form and application of Measures as follows:

A. *Conditions that can be subject to Measures*

Article 38 of the National Criminal Code states that if a person at the time of committing a crime has a mental and/or intellectual disability, then the punishment for that person can be reduced by criminal sanctions and/or be subject to Measures. The option of imposing criminal sanctions remains an option, but because of the condition of the perpetrator who is "disabled", this factor makes the criminal sanctions can be reduced. In addition to being reduced, Measures can also be imposed, which, in this case, function as a form of improvement or recovery for the perpetrator who is "disabled".

"Mental disability" is a disturbance in the function of thinking, emotions, and behaviour, including a. psychosocial, including schizophrenia, bipolar, depression, anxiety, and personality disorders; and b. developmental disabilities that affect the ability to interact socially, including autism and hyperactivity. What is meant by "intellectual disability" is a disturbance in the function of thinking due to a below-average level of intelligence, including slow learning, intellectual disabilities, and Down syndrome. Criminals who have mental and/or intellectual disabilities are considered less able to realize the unlawful nature of the actions they have committed or to act based on the awareness that they can be punished.

Mental disabilities include various conditions such as developmental disorders, mental disorders, anxiety disorders, mood disorders, and neurological disorders that affect the cognitive, emotional, social, or behavioural functions of an individual. In some cases of criminal acts, it is not uncommon to find that the perpetrators of the criminal acts are people with mental disabilities. As a result, there is a particular urgency regarding the regulations that form the legal basis for deciding criminal responsibility for them. (Hidayat & Ibrahim, 2023) All citizens are treated without any differentiating factors in obtaining their rights, as well as people with intellectual disabilities when they are in a condition as perpetrators, victims or witnesses. People with intellectual disabilities with conditions that have disorders in thinking function or growth and development require special handling from law enforcement officers in order to create fair and inclusive law enforcement. (Listiwati, Fauzi, Mande Nata, & Jamaludin, 2023)

Article 39 of the National Criminal Code states that anyone who, at the time of committing a Criminal Act, has a mental disability that is in a state of acute relapse and is accompanied by psychotic symptoms and/or moderate or severe intellectual disability cannot be sentenced, but can be subject to Measures. The article states that people who experience acute and/or moderate/severe "disabilities" can eliminate the perpetrator's guilt because they are considered unable to take responsibility.

Measures: The New Face of Criminal Punishment in the New Indonesian Criminal Code

This requires an expert in the field of Mental Health to assess whether they are indeed unable to take responsibility or not because of the "disability".

The perpetrator may not be subject to punishment and measures by looking at the severity of the act, the personal circumstances of the perpetrator, the circumstances at the time it was committed and what happened later by considering the aspects of justice and humanity. In criminal law, it is known as *rechterlijk pardon* or the Judge's forgiveness. The Judge may not impose sanctions even though there is an unlawful act and the perpetrator can be responsible, per Article 54 paragraph (2) of the National Criminal Code.

In addition to people with disabilities, children can also be subject to measures. Children who can be subject to measures are children under 14 (fourteen) years old. This is based on the consideration that the child is still growing and developing and looking at the child's psychology. This is by Article 113 paragraph (3) of the National Criminal Code and Article 69 paragraph (1) of Law No. 11 of 2012 concerning the Juvenile Criminal Justice System. The most important basis for the Judge's consideration in imposing punishment on children is the legal consideration, namely drawing facts in the trial that arise, which are conclusions from the statements of witnesses, the statements of the child defendant, and the evidence submitted. (Sompie, Rusdiyanto, & Badu, 2024) In addition to legal considerations, judges must also consider all aspects, such as the child's personal circumstances, relationships with family, environment, and society, to determine which sanctions are more appropriate to be imposed on the child to protect the child's future.

In Indonesia, corporations were first recognized as subjects of criminal law through Law Number 17 of 1951 concerning the hoarding of goods. In the 1950s, corporations began to be described as subjects of criminal law in the renewal of Indonesian criminal law. Criminal liability imposed on corporations in criminal law is also known as "corporate criminal liability" or corporate criminal liability. (Faturachman, Hutasoit, & Hosnah, 2024)

Corporations can be held criminally liable since 1955, with the implementation of Emergency Law No. 7 1955 concerning Economic Crimes. From this concept, outside the Criminal Code, it is also regulated that not only natural persons can be subject to criminal penalties, but also legal persons. According to available data, few criminal proceedings have prosecuted corporations and imposed penalties. This gave rise to corporate liability, which recognizes corporations as subjects of criminal law. (Faturachman et al., 2024) Corporations can be considered to have committed a crime based on the actions of the person who controls the corporation's management. The difference in the regulation of criminal liability for corporations that commit crimes in Indonesian law will result in weak law enforcement against corporate crimes. The role of the Government, the DPR and the community is very much needed to fix this problem because the development of forms of crime follows the development of the era. (Wahyuni, 2024) In addition to being subject to punishment, corporations can be subject to sanctions in the National Criminal Code. Article 56 of the National Criminal Code, the imposition of sanctions on Corporations, judges must consider: a. level of loss or impact caused; b. level of involvement of management who have functional positions in the Corporation and/or roles as order givers, controllers, and/or beneficial owners of the Corporation; c. duration of Criminal Acts that have been committed; d. frequency of Criminal Acts by the Corporation; e. form of Criminal Act error; f. involvement of Officials; g. legal and justice values that exist in society; h. track record of the Corporation in conducting business or activities; i. influence of criminal sanctions on the Corporation and/or j. cooperation of the Corporation in handling Criminal Acts.

B. Types and Enforcement of Measures

The type and enforcement of measures can be seen in Chapter III, Part Two, Paragraph Two. Article 103 of the National Criminal Code regulates measures that can be imposed together with punishment, namely:

1. Counseling

Counselling is the process of providing guidance or assistance in order to overcome problems and change behaviour to be positive and constructive.

2. Rehabilitation

Rehabilitation includes medical or social rehabilitation as an integrated physical, mental, and social recovery process so that the person concerned can return to carrying out positive and constructive social functions and becoming and becoming excellent and functional citizens.

3. Job training

Job training is an activity of providing skills to people who are given actions to prepare them to return to society and enter the workforce

4. Treatment in institutions

The institution here is an institution that organizes affairs in the field of social welfare, both government and private

5. Improvement due to criminal acts

Measures: The New Face of Criminal Punishment in the New Indonesian Criminal Code

Improving all the consequences that arise, including the impact or consequences of the criminal act.

Measures above are formulated in a combined manner, namely "and/or," meaning that measures can be imposed on one type or more than one type.

In addition to the measures for these measures, special measures are imposed on people who experience "disabilities", as stated in Articles 38 and 39 of the National Criminal Code. Specifically for people who experience mental and intellectual disabilities, whether ordinary or acute or moderate/severe, the following measures can be imposed:

1. rehabilitation;

"rehabilitation" in this provision is a service process provided to someone who has a disability either since birth or not since birth to restore and maintain function and develop independence so that they can be active and participate fully in all aspects of life

2. handover to someone;

Someone here is the perpetrator's family, who can care for or another party who cares and can care for the person concerned

3. care in an institution;

4. handover to the government and/or

5. care in a mental hospital

The perpetrator can be treated in a mental hospital to be given rehabilitation both medically, socially, and psychosocially.

In deciding on the form of imposing sanctions, the judge must state the decision in detail, including type, duration, place, and/or implementation. In sentencing, the judge must pay attention to the objectives and guidelines for sentencing as stated in Articles 51 to 54 of the National Criminal Code, namely:

1. Purpose of Sentencing: Preventing the commission of Criminal Acts by enforcing legal norms for the protection and protection of society, socializing convicts by providing guidance and mentoring to become excellent and valuable people; resolving conflicts caused by Criminal Acts, restoring balance and bringing a sense of security and peace in society, and fostering a sense of regret and freeing the convict from guilt

2. Sentencing guidelines:

a. Judges are required to uphold the law and justice. Justice must be prioritized if there is a conflict between legal certainty and justice. This is based on the purpose of the law itself; Prof. Satjipto Rahardjo said that the law is for humans, not humans for the law (progressive law). If seeking a legal solution, then what is sought is not certainty but justice that can be felt by all parties (perpetrators, victims, and society)

b. In imposing sanctions, judges must consider: 1) the form of the perpetrator's mistake in the Criminal Act; 1) motive and purpose of committing a crime; 2) the mental attitude of the perpetrator of the crime; 3) whether the crime was committed with or without planning; 4) how to commit the crime; 5) the attitude and actions of the perpetrator after committing the crime; 6) life history, social conditions, and economic conditions of the perpetrator of the crime; 7) the influence of the crime on the future of the perpetrator of the crime; 8) the influence of the crime on the victim or the victim's family; 9) forgiveness from the victim and the victim's family; and/or 10) the values of law and justice that live in society.

3. Regarding rechterlijk pardon or the judge's forgiveness

4. In addition to the above, sanctions can be given to children and corporations as subjects of criminal law. Regarding children, there are further details regarding the requirements for imposing criminal sanctions and Measures.

Children under 14 (fourteen) years cannot be subject to punishment, but only measures. The sanctions that can be imposed on children are: 1. return to parents/guardians; 2. surrender to someone; 3. treatment in a mental hospital; 4. treatment in an institution; 5. obligation to attend formal education and/or training held by the government or private agencies; 6. revocation of driving license; and 7. improvement due to criminal acts. Corporations are subjects of criminal law that are not in the WvS Criminal Code. Corporate legal subjects emerge not based on the WvS Criminal Code but rather on laws outside the Criminal Code. The sanctions that can be imposed on corporations are 1. Takeover of the Corporation; 2. Placement under supervision; and/or 3. Placement of the Corporation under guardianship.

V. CONCLUSIONS

There are several conditions for criminal law subjects to be subject to measures, including individuals, including perpetrators with mental and intellectual disabilities. The mental and intellectual disabilities may be in normal conditions or acute relapse or moderate/severe degrees. In addition to perpetrators with disabilities, measures can also be imposed on children, but the child must be under 14 (fourteen) years old. Corporations are also one of the subjects of criminal law that can be subject to measures. In imposing measures, the objectives and guidelines for sentencing must be considered as in Articles 51 to 54 of the National Criminal Code.

Measures: The New Face of Criminal Punishment in the New Indonesian Criminal Code

Forms and implementation of measures for ordinary perpetrators and those with mental or intellectual disabilities include Counseling, Rehabilitation, Job training, Treatment in Institutions, Improvement due to criminal acts, surrender to someone, and treatment in a mental hospital. For children under 14 (fourteen) years of age are: return to parents/guardians, surrender to someone, treatment in a mental hospital, treatment in an institution, obligation to attend formal education and/or training held by the government or private agencies, revocation of driving license; and/or improvement due to criminal acts. In addition to perpetrators, perpetrators with mental or intellectual disabilities, and children, sanctions that can be imposed on corporations include takeover of the corporation, placement under supervision, and/or placement of the corporation under guardianship.

REFERENCES

- 1) Fadhilah, M., Zulkarnain, I., Yulianto, H., & Satory, A. (2024). Sejarah Hukum Pidana Materil Indonesia: Urgensi Pembaharuan Dan Permasalahan Pasca Pengesahan KUHP Baru. *Jurnal Prisma Hukum*, 8(1), 13–29.
- 2) Faturachman, F. A., Hutasoit, T. J. ., & Hosnah, A. U. (2024). Pertanggungjawaban dan Penegakan Hukum Pidana Korporasi dalam Tindak Pidana Korupsi di Indonesia. *AKADEMIK: Jurnal Mahasiswa Humanis*, 4(2), 197–212. <https://doi.org/10.37481/jmh.v4i2.731>
- 3) Hidayat, F. A. M., & Ibrahim, A. L. (2023). Disharmoni Pertanggungjawaban Pidana Disabilitas Mental Dalam Hukum Positif Di Indonesia. *Justisi*, 9(3), 326–343. <https://doi.org/10.33506/jurnaljustisi.v9i3.2474>
- 4) Listiawati, E., Fauzi, E., Mande Nata, L., & Jamaludin, A. (2023). Acces to Justice Penyandang Disabilitas Intelektual: Peradilan Pidana sebagai Implementasi Equality Before the Law. *Simbur Cahaya*, 15(1), 178–187. <https://doi.org/10.28946/sc.v30i1.2796>
- 5) Malau, P. (2023). Tinjauan Kitab Undang-Undang Hukum Pidana (KUHP) Baru 2023. *AL-MANHAJ: Jurnal Hukum Dan Pranata Sosial Islam*, 5(1), 837–844. <https://doi.org/10.37680/almanhaj.v5i1.2815>
- 6) Manullang, S. O., Tompul, V. br, Kusumadewi, Y., Krisnalita, L. Y., & Mutiarany, M. (2023). Daya Ikat KUHP Nasional terhadap Eksistensi Undang-Undang Khusus Sebelumnya Ditinjau dari Perspektif Filsafat Hukum. *Jurnal Pendidikan Tambusai*, 7(2), 17340–17346. <https://doi.org/10.31004/JPTAM.V7I2.9112>
- 7) Nasution, M. I., Ali, M., & Lubis, F. (2024). Pembaruan Sistem Pemidanaan di Indonesia: Kajian Literatur atas KUHP Baru. *Judge: Jurnal Hukum*, 05(01), 16–23.
- 8) Rivanie, S. S., Muchtar, S., Muin, A. M., Prasetya, A. M. D., & Rizky., A. (2022). Development of Theories of the Purpose of Punishment. *Halu Oleo Law Review*, 6(2), 176–188.
- 9) Setiadi, E. (2011). Membangun KUHP Nasional yang Berbasis Ke-Indonesiaan. *Mimbar*, XXVII(2), 203–212.
- 10) Sompie, A., Rusdiyanto, M., & Badu, L. W. (2024). Penyelesaian Tindak Pidana Dan Penerapan Sanksi Asusila Oleh Anak Di Bawah Umur Di Gorontalo . Lingkup Undang-undang tentang Hak Asasi Manusia serta Undang-undang tentang. *Kajian Ilmu Hukum Dan Politik*, 2(1).
- 11) Wahyuni, S. (2024). Makna Korporasi sebagai Subjek Hukum dalam Pembaharuan KUHP Indonesia. *Innovative: Journal Of Social Science Research*, 4(3), 3051–3061.
- 12) Winda Apriani Zarona Harahap, Asep Syarifuddin, B. H. (2021). Hukum Di Indonesia the Effect of Social Change in the Development of Law. *Jurnal Lex Suprema*, III(1), 549–565.
- 13) Zainuddin, M., Mubarak, Z., & Bachriani, R. D. (2022). Politik Hukum Restorative Justice Dalam. *Semarang Law Review (SLR)*, 3(2022), 120–129.



There is an Open Access article, distributed under the term of the Creative Commons Attribution – Non Commercial 4.0 International (CC BY-NC 4.0)

(<https://creativecommons.org/licenses/by-nc/4.0/>), which permits remixing, adapting and building upon the work for non-commercial use, provided the original work is properly cited.

Sustainable Oyster Mushroom Livelihood Development Project for Rural Communities of Ilocos Sur



Mary Ruth O. Menor

Ilocos Sur Polytechnic State College

ABSTRACT: This research was conducted to determine the contributions of the stakeholders of oyster mushroom livelihood project particularly on their participation on technical services and adequacy/availability of financial services; to determine the challenges encountered in terms of knowledge, willingness, attitude and policy implementation; and develop a framework that can help to address sustainability of the mushroom livelihood project.

Four municipalities in Ilocos Sur Province were selected as research site using an inclusion criteria. A constructed survey questionnaire and an interview guide were used to gather data which were collated and interpreted using the point scale, range of values, and descriptive equivalent.

As prevailed in the research study, there is high participation on the technical support of the LGU in all activities of the mushroom livelihood project. However, the mushroom growers consistently claimed a low to moderate participation of LGUs on the support to development initiatives of the mushroom livelihood project and formalizing involvement of funding agencies and other stakeholders through a MOA. On the area of financial support, LGUs provided highly available/adequate support according to them but mushroom growers mentioned they received moderately available/adequate financial support.

On the knowledge, willingness, and attitude of mushroom growers, there were no challenges encountered. This suggests that they have already the knowledge and capabilities of producing and managing their mushroom livelihood. They just needed enhancement in order to prove more about the technology and its management. On the policy implementation, the LGUs have encountered varied challenges in the area of technical policies, but overall, the LGUs and the mushroom growers revealed that they encountered very serious challenges. On the financial policies aspect, the LGUs encountered a very serious challenge, specifically on the allocation of funds for monitoring activities.

Overall, a low to moderate participation of LGUs on their technical support, a moderately available/adequate financial support, and challenged with the problem on policy implementation prevailed based from the result of the study, hence, the sustainability mechanism and development framework on oyster mushroom livelihood development project is hereby recommended to help achieve sustainable rural community development through participation and empowerment of the stakeholders.

THE PROBLEM

BACKGROUND OF THE STUDY

The Sustainable Development Goals (SDGs) of the United Nations (UN) are a bold commitment to continue what were established from the Millennium Development Goals (MDGs). MDGs, which started a global effort in 2000, aims primarily to establish a measurable and universally agreed objectives for tackling extreme poverty and hunger, improve health services, expanding primary education, and achieve full gender equality, among others. The SDGs, which was conceived in 2012 at the Rio de Janeiro during the Conference of the United Nations regarding Sustainable Development, are committed to tackle some of the more pressing challenges facing the world today, of which there are 17 goals interconnected with each other (UNDP, 2021).

The United Nations is a constant partner of the Philippine government in achieving national development goals including the 17 SDGs. Priorities have been mapped directly and indirectly into the Philippine Development Plan (PDP), focusing on areas where a great impact is no one will be left behind, hence localization of the SDGs are done in order to achieve sustainability from

Sustainable Oyster Mushroom Livelihood Development Project for Rural Communities of Ilocos Sur

the national down to the regional level. This is also done in order to resolve any gaps and achieve complementation among the concerned agencies while strategies and priorities are taken into places. ("The 2019 Voluntary National Review of the Philippines").

A solid framework was laid down by the National Economic Development Authority (NEDA) in achieving the "Ambisyon Natin" for more inclusive growth, a resilient community, and a globally competitive economy by the end of 2022 ("Philippine Development Plan 2017-2022 overall framework"). Hence, the SDGs, being cascaded through the PDP include the development of different sustainable livelihood program which provided different opportunities for the local communities to undertake such as income-generating activities and livelihood development among others (World Bank, 2018).

Many small- and medium-term enterprise and livelihood projects have been introduced both in the rural and urban communities by the national government in partnership with the local units and other stakeholders to help resolve issues on low productivity and low income. One of which is the oyster mushroom livelihood project which generally aims to help the community increase their productivity and income. Rehman and Ghafoor (2021) state that mushroom livelihood is the best source of livelihood to attain sustainable development goals set by the UN.

Globally, mushroom production started in the 1800's. Consumption of mushrooms has increased from 1 to 4.7 kg of cultivated edible mushrooms per capita from 1997 to 2013. Also, in 2013, 63 billion US dollars have been reached in marketing mushrooms (Royse, et.al.2017). The demand of mushroom has been increasing as the population grow while more expansions and developments in the manufacturing of mushroom industries intensify. An analyst of Zion Market Research (2018) said that the global mushroom market in 2015 was capitalized at more than 35.08 billion US dollars with a compound annual growth rate (CAGR) of slightly more than 9.2 percent. A recent study said that global market size in 2021 was valued at 50.3 billion US dollars (Brosas, 2023/agrario.com). It is anticipated to increase at 9.7% CAGR from 2022 to 2030.

Based on the Food and Agriculture Organization (FAO), China, Poland, the US of America, the Netherlands, and Spain were among the top five major producers of mushrooms in the world. Zhang (2014) said that mushrooms have become the products of more than 25 million farmers in China. In 2018, China contributed almost 77% of global production. This showed a rapid growth of mushroom farms and livelihood and contributed to food security and sustainable income source (Wendiro, et.al., 2019).

In the Philippines, its mushroom industry has intensified subsequently in 1995 considering its estimated production of around 27,000 metric tons annually (Brosas, 2023/agrario.com). Chang, et.al. (2014) claimed that growing mushrooms is feasible because of its cheaper production cost, available and free agricultural crop residues while its products' demand is high. With this, it gave the mushroom industry a boost in the rural communities which is vital in creating employment and raise income, particularly the small farmers.

Oyster mushroom livelihood is commonly small in the country but an intensive production of mushroom provides good alternative source of income for small-scale enterprises especially those who have small piece of land. With mushroom consumption increasing, farm lands are decreasing along with drought problem and occurrences of natural calamities, pushed farmers to produce mushrooms. Various studies have been done regarding mushroom production and its marketing and business opportunities. The increasing awareness on the nutritional value and health benefits of oyster mushrooms leads the community to adopt, cultivate, and engage in oyster mushroom production which serve not just as an alternative source of food, income and labor but also as a sustainable livelihood (Sanchez, 2004, cited by Balan, et. al., 2022). It revolutionizes the continuous production of mushrooms to supply the increasing demands of the consumers which can bring a change to the food system and health condition in the community. It helps improve their economic activities and social involvement while increasing their opportunities to have an alternative source of income helping reduce economic challenges as it strengthens livelihoods. (AgriTalk, Manila Bulletin by Medenilla, 2020). However, it was recorded also by Chang, et.al. (2014) that the lowest production volume was 355 metric tons (MT) in 2009. The country has been importing mushrooms from Japan, Thailand, China, Taiwan, Malaysia, Korea due to low production and high demand. Despite that oyster mushroom livelihood project have been introduced in the country its contribution to the market demand is only 10% in 2020. (AgriTalk, Manila Bulletin by Medenilla, 2020).

In the Ilocos Region, the Philippine Council for Agriculture, Aquatic and Natural Resources Research and Development of the Department of Science and Technology (DOST-PCAARRD, 2017) launched and provided a fund support to an oyster mushroom production project which was promoted as an alternative source of livelihood in the three provinces of Ilocos Region. In the Province of Ilocos Sur, the beneficiaries included the different rural communities of San Emilio, Suyo, Lidlidda, Alilem and Cervantes, to generate an alternative livelihood for the vulnerable farmers (Javier, 2019). Mushroom experts and enthusiasts

Sustainable Oyster Mushroom Livelihood Development Project for Rural Communities of Ilocos Sur

claimed that oyster mushroom project can be a sustainable livelihood that provide very good opportunity to develop and sustain living conditions of the rural community as they can utilize their local resources.

According to a survey conducted by Martins (2020), 37% of livelihood say that one of the main reasons development initiatives succeed is seen between the specific initiative and activities and the general goal. However, a greater portion say that livelihood projects are likely failed. This is evident with the issues on food security, poverty and employment that remain as the key problems of which sustainable livelihood should have been addressing. Hence, it is within this context that the researcher wanted to determine the contributions of the Local Government Units of whom development projects were cascaded; and determine the challenges that they met in the implementation of the oyster mushroom livelihood projects.

Statement of the Problem

Despite the bright prospects for oyster mushroom production, production is still low. Even with the local government units (LGUs) development advocacies on oyster mushroom project, there are limitations on opportunity takers on mushroom livelihood to help intensify and sustain for rural communities. It is within this context that the researcher would like to determine the contributions and participation of the stakeholders, identify the problems encountered in achieving sustainable oyster mushroom livelihood, and analyze these in developing a sustainability mechanism towards rural community development.

After identifying these gaps, the researcher was able to determine influencing factors in addressing the concerns in sustaining oyster mushroom livelihood in Ilocos Sur. This research sought to address the following questions:

1. What are the contributions of the stakeholders in sustaining the oyster mushroom livelihood project?
2. What are the challenges met by the stakeholders of oyster mushroom livelihood in terms of knowledge, willingness, and attitude towards sustainability and rural development alongside with policy implementation?
3. How to develop a rural development program mechanism and framework in addressing the challenges in sustaining the oyster mushroom livelihood project in Ilocos Sur?

Significance of the Study

The research result would be beneficial to the local executives in the development of a sustainable livelihood projects for rural communities. It will serve as basis for roadmap in developing sustainable rural and community development. In terms of economic aspect, the local leaders will have clearer perspectives on productivity and profitability enhancement activities in uplifting and contributing the living conditions of farmers and those involved in related livelihoods like mushroom production. In relation to this, financial institutions will be informed to support the initiatives of these local government units as well as other entities implementing livelihood programs in rural communities.

The sustainable mechanism including the development framework could be very helpful in managing projects which could be later validated or replicated in different localities.

In addition, faculty researchers and the students pursuing further research studies could use this as basis for techno-preneurial projects in sustaining support to rural development particularly with rural people and entrepreneurs interested in pursuing an oyster mushroom livelihood focused in achieving and increasing productivity and income.

Scope and Limitation of the Study

The respondents focused on the stakeholders who contributed to the oyster mushroom livelihood project (OMLP) in Ilocos Sur, particularly in rural communities benefitting from the said livelihood including the establishment and utilization of the oyster mushroom production technology. The Municipalities of Narvacan, San Esteban, San Juan, and Sta Catalinain Ilocos Sur served as research sites based on the inclusion criteria and the people's involvement in OMLP and its massive technology diffusion, participation and utilization in boosting the local mushroom industry in the municipality.

Specifically, the general criteria used were 1.) Attendance to trainings on oyster mushroom production, 2.) adoption of mushroom production technology; 3.) Establishment of mushroom farm production area, and 4.) production scales, namely: (a) a large farm area with 2000 fruiting bags and above which produces at least 10 kilograms of fresh mushrooms daily, (b) a minimal production farm area with 1000-2000 fruiting bags and produces at least 5-10 kilograms of fresh mushroom a day, and (c) a low production farm or a beginner with 100-1000 fruiting bags which produces at least 1-5 kilograms of fresh mushroom a day.

Furthermore, the different research sites will be treated as cases in deriving sustainability influencing factors in ensuring that an appropriate modality will be developed specifically for rural communities implementing livelihood programs. Collective community characterization will be done in this study which will not include the profile of oyster mushroom livelihood project farmer/owners.

Sustainable Oyster Mushroom Livelihood Development Project for Rural Communities of Ilocos Sur

REVIEW OF LITERATURE

This chapter presents a comprehensive review of literatures, reviews and researches previously conducted that are useful in understanding the focus of the research on sustainability, program operation and management, and rural development. The theoretical and conceptual frameworks were also presented in this chapter.

Contributions or Influence of Sustainability in relation to Livelihood Development Projects

The sustainable development goals (SDGs) are explicit that they include issues that most likely to affect the living condition of the general people and affirms commitment to end poverty globally (Mensah and Ricart, 2019). They involve participation of all concerns in building not just safer but also a more sustainable and prosperous humanity (UNDP, 2021). The SDGs appeal for action to fight the battle against poverty, protect the environment, and ensure that each of the member of a community can enjoy harmony among men and achieve prosperity (United Nations, n.d.). In terms of the agriculture sector, productivity is given much concern through the development of an integrated agriculture farming system with strengthened collaboration between and among the agencies from the national down to the local agencies, dubbed in the last agriculture program "*matatag, maginhawa at panatag na buhay ang bawat mamayang*" Filipino [strong, comfortable, and tranquil life for every Filipino citizen].

With the growing concern about sustainability of food and income-source, the "Plant, Plant, Plant Program" of the country is recognized as an important pillar to support development programs. Experts have become quite busy with new scientific methods to be implemented, particularly in edible farming. Now that people are more concerned with their health and much more on their accessibility to a sustainable livelihood, every agency tried to take measures on how this "new normal set-up" can be adapted, to which every individual can normally do their task.

In conjunction with this, each Department leader pursued and supported the other means that can provide an ease to the situations arising thereafter. The Department of Agriculture (DA), addressed this big challenge and had taken to promoting "Urban Gardening" or backyard gardening as an easy agricultural practice for women and youth especially, and a suitable income-generating enterprise capable of transforming a country's economy (Dar 2020).

According to Marquez-Ramos and Mourelle (2019), development is equated to sustained economic growth, as manifested by increases in production and investment levels within a locality. Development is often viewed as a dynamic societal change from one current situation to another, with the connotation that the latter is preferable. The development process in the locality increases personal and institutional capacities, mobilizing and managing the resources needed to produce sustainable and justly-distributed improvements to the quality of their lives, which is consistent with their own aspirations.

On the other hand, the view of development as a process that is multidimensional has also been asserted by Chakravarty (2017) as it involves not only reorganizing and reorienting the entire system, both economic and social, but also radical changes in social and administrative structures, in beliefs and attitudes, and even in customs and traditions. Development is the fundamental transformation of man, implying some internal and external changes. By external, it refers to how man is concerned with environment, modernization, and industrialization, and by internal, the transformation of values attitudes and feelings.

De la Rosa (2013) also implies that development is a process that is continuous and dynamic and not a stable state or condition. It recognizes that people should control and have access to resources, but it also considers the limits that it should lead to a sustainable use of physical resources and that it should be within the tenets of justice and equality. It acknowledges that it is the people who can define what they consider as improvements in the quality of life, hence developing the countryside involves strategies that could spur local economy. The goal of development is to create an environment that enables people to enjoy longer, healthier, and more creative lives. This may appear as the simple truth, but it is often neglected since other more immediate concerns are regarded with more importance. Human development is the end goal and not the means in development and progress.

Heshmati, A., et.al. (2015) mentioned that a lot of development policies and strategies aimed at poverty reduction were given in larger enterprises and livelihoods and focused on urbanization which overlooked the crucial role of the local executives. As a result, the majority of the rural community remained sluggish resulting in stagnant development.

Development programs/projects involve bridging the gap between a present state through deliberate courses of action, thus playing a vital role in a livelihood project's growth and success, since these lead the stakeholders on how to respond to every opportunity and challenge. According to a survey conducted by Martins (2020), less than 40% of livelihoods responded that one main reason that strategic initiatives have been successful is that the specific initiative and the activities of the initiative fitted well with the overall goal. The establishment of development programs involves commitment and it has to be seen and felt by the rural community.

Sustainable Oyster Mushroom Livelihood Development Project for Rural Communities of Ilocos Sur

The participation or involvement of all stakeholders in the crafting and establishment of sustainable livelihood programs is very necessary to meet goals and objectives. Aside from the implementers themselves, stakeholders must include the people of the community so that the perceived attributes on sustainability and expectations for the livelihood are met.

Generally, rural development envisions achieving an empowered community for sustainable livelihood. And this is one of the focused agenda of the government for the rural community to be capacitated with entrepreneurial mind-set in order to achieve a sustainable livelihood while creating a sustainable processing and market niche (Taculao, 2020).

For the community in the Philippines, development is a process in which the people's efforts unite with the government agencies to help improve their economic, social and cultural conditions, integrating them into the nation's life, and enables them to contribute fully to the progress of the country, and this view is supported by the United Nations.

Challenges, People's Perspective and Views In Development Program/Project

John Teye (2017) assumes individual preferences to choices that maximize the individual's happiness or helpfulness among alternatives or other options that are available. In other words, individuals often choose the best action based on their personal preferences and any constraints that they face.

Unger (2014) sees that each individual possesses the capability to advance towards an even greater life. "The world is made and imagined" is the conviction at the core of this social thought. For Unger, the market, the state, and human social organization need to be left open for experimentation and revision of technology instead of being set in predetermined institutional arrangements, which is aligned to what applies to a project and for individual and collective empowerment.

Competencies are known as the behavioral level of one's capability, which is created with the help of the work on leadership and management (National Research Council Canada, 2019), which encompasses knowledge, skills, attitude, and actions. These competencies play a vital role in adopting and implementing mushroom production technologies relative to the knowledge and traditional personality traits of the individual or people in order to meet desired results.

According to Leeuwis (2021), there are four aspects to consider in terms of people's participation and technology adoption: knowledge, willingness, ability. These are helpful in appreciating rural community's capacity at a given time for contributing to change and innovation. Farmers would have to compare the claims over benefits before they adopt an innovation. Growers will employ a technology if they already fully comprehended the advantages and disadvantages related to it.

Oyster mushroom production technology. The cultivation of edible mushrooms has been considered as a most economically viable process specifically for the biological conversion of ligno-cellulosic wastes (Kumla, et.al. 2020). Particularly, *Pleurotus* spp. or the oyster mushroom can be easily grown, especially by women in rural areas, with the least efforts.

Oyster mushroom cultivation can become an alternative source of income, providing employment in semi-urban and rural areas and uplifting the living standard of low-income farmers. It can also be an additional source of high-quality protein in their daily food intake, eradicating problems such as malnutrition, and uplifting not only the economic and social status of rural people and families but also their nutritional status.

With improvements and innovations in technology, livelihood in oyster mushroom production continues to expand and generate economic growth, a boundless opportunity for rural farmers. The poverty status of small farmers are also managed through the help of more sustainable agricultural practices (Vinita Rajput and Ravika, 2020).

As Prabhakar et al. (2021) cited, oyster mushroom production provides an additional or alternative income especially to those farmers who are looking for value-added products. The utilization of by-products or co-products of other crops can be a way for them to supplement their farm income. It improves their economic activities and social involvement while increasing their opportunities to have an alternative source of livelihood. This helps in reducing their vulnerability to falling into poverty. It also strengthens their livelihood when a quick-yielding, nourishing food source and a reliable income source are generated. Ultimately, mushroom production has a high market demand, but its contribution is only 10% in 2020, thus supply is still limited (Medenilla, 2020).

However, Asian Development Bank (2018) mentioned that there are numerous economic policies and strategies that have previously been introduced in addressing poverty and generating equitable growth but attention was turned to bigger enterprises, urban and urbanizing communities, and centralized planning, thus the fact that local executives can play a crucial role had been missed. This also resulted in the rural economy remaining slow-moving, affecting the Filipinos who live and worked in these areas and contributing to the continued as well as increased poverty incidence and poorer quality of life for these Filipinos.

Mushroom farming has been giving a large share to household income of many farmers over the past thirty years since it has been primary carried out by many people in the rural community. This is most particularly concentrated in tropical and warm places where small-scale enterprises have captured the regional supply market centers. The Chinese Edible Fungi Association, for

Sustainable Oyster Mushroom Livelihood Development Project for Rural Communities of Ilocos Sur

instance, has listed a production of 95% being produced by small-scale growers which consequently became a sustainable livelihood up to the present (Thakur, 2020).

According to Ongoche (2019) mushroom farming contributed to rural development in Kenya. It provided the small farms to improve and sustain their small-scale enterprise. The Kenya Institute of Organic Farming (KIOF) envisions achieving a sustainable livelihood among the rural communities empowered with skills and knowledge to achieve rural development. Among these skills include mushroom production.

An expansion of the oyster mushroom livelihood has been seen in Nepal. The community became aware of the health benefits of adding mushroom in their diet, hence there is an increased in market demand. Because of this growing consciousness, mushroom cultivation one of the most sought livelihoods among the farming communities. Moxley et al. (2022) added to his findings that the net income and production obtained by the mushroom growers make mushroom livelihood a sustainable one. Accordingly, oyster mushroom livelihood gains acceptance among farmers because of the social, economic and environmental impact it can derive.

Sustainable livelihoods

According to the UN (2019), sustainable livelihood is a key agenda for ensuring the capabilities, assets and activities required to cope for the present situation where farming families are most affected. This came as a revolutionary development concept in the 1990s drawing from the crises such as poverty, food scarcity, and unemployment which is felt by the general people up to now. Hence a livelihood is called sustainable when it can cope from the crisis which comprised the capabilities, material and social assets, and activities prioritizing development and providing means to surpass economic issues, particularly on increasing income and productivity.

Considering the impacts of climate change such as management of natural and indigenous resources, eradicating poverty and fostering inclusive societies help reduce inequality and help economies prosper, hence the greatest chance to help improve the living status of the global community while sustaining the production of needs of the future generation.

The concept of sustainability emerged from the "Global Agenda for Change" which aimed to safeguard and meets the needs of today in consideration of tomorrow's generations and able to provide for their own needs (World Commission on Environment and Development, n.d.). This concept internationally influence economic, social, and environmental issues (United Nations Economic Commission for Europe, 2017 as cited in Physiopedia, n.d.).

Sustainability involves resources being efficiently and equitably distributed, wherein socio-economic activities are confined within a finite environment (Bova and Lin, 2022). Sustainability in rural development envisions achieving empowered communities, with the skills and knowledge of traditional farming needed for a more sustainable livelihood. In extension to this, sustainable rural livelihood means that households have food security, due to the utilization of innovations in agriculture. This also addresses the issue of reaching a competitive structure, increasing job opportunities and development in agriculture, as a majority of the lower income classes are found in or employed mainly on family-run farms.

Also, many of the enterprise development and alternative livelihoods interventions are implemented simultaneously with resource conservation or management initiatives creating conflict or less appreciation of the enterprise or livelihood initiatives. It is critical (5) to have clear project or program objectives that are locally specific but that are coherent with larger economic, social and environmental policy guided by the UN's SDGs cascaded through the PDP down to the mainstream.

Most development agencies adopt the Chambers and Conway (1992) definition of livelihoods (or some slight variation on this) which holds that: A livelihood comprises the capabilities, assets (stores, resources, claims and access) and activities required for a means of living: a livelihood is sustainable which can cope with and recover from stress and shocks, maintain or enhance its capabilities and assets, and provide sustainable livelihood opportunities for the next generation; and which contributes net benefits to other livelihoods at the local and global levels and in the long and short term (da Silva Junior, 2020).

Oyster mushroom livelihood program is characterized as a shift of farmers' activities from their on-farm activities, which offers an additional income to households thru widening their options (Gautam et al., 2016). According to Loison in 2015, smallholders who have sufficient assets are more successful in establishing a livelihood program because they are eager to learn new technologies and are excited to accept opportunities.

Sustainable livelihood framework, which is implemented by the stakeholders, is a way to organize thinking and use as a guide on sustainability as well as policy, support services management, and monitoring and evaluation of activities to sustain development outcomes in larger population (Center for Design and Research in Sustainability, n.d.). It is a tool developed by the Sustainable Rural Livelihoods Advisory Committee, to improve understanding of livelihoods for the poor and vulnerable. According to the Department for International Development, now the Foreign Commonwealth Development Office (2020), this framework

Sustainable Oyster Mushroom Livelihood Development Project for Rural Communities of Ilocos Sur

is a simple and adaptable framework which presents the indicators that affect livelihood sustainability. This framework is very important in formulating new plans and activities and helps in the assessment leading to livelihood sustainability. Among the factors include people’s participation, technology trends, and production trends.

Theoretical Framework

Behavioral theory explains that a human behavior is analyzed through the antecedents and consequences that is present in an individual’s general environment which a person acquired through experiences (Angell, 2013).

Community dynamism portrays community structure where change and development may occur over time. It gives valuable insight on how community feel about their environment which help them decide about which services are offered in a particular location. It aims to cater the primary needs of the community before implementing any development services. This will help boost the success implementation of services to the community (Blogger, 2018). A community is said to be dynamic when people are brought together to create an advocacy whereby supporting each other to overcome challenges.

Rogers’ (1962) Diffusion of Innovation suggests that people must recognize that the impact of technology depends on individual preferences and these could play major roles in their participation and adoption. Rogers argued that any technology or innovation that is apparently as new by any person could be considered an innovation available for observation, testing and creation of awareness. It also describes the patterns at which new innovations spread through a group of people (Halton, 2021).

As shown in Figure 1, if modernization takes place there are innovations introduced and development project established in the rural community considering that this livelihood is community-based system where comparative advantage is recognized and the behavior of the different stakeholders are also considered so that community and social dynamism would take into place, hence, these perspectives and principles are inherent for a productive and profitable livelihood achieving a sustainable oyster mushroom production in the rural community.

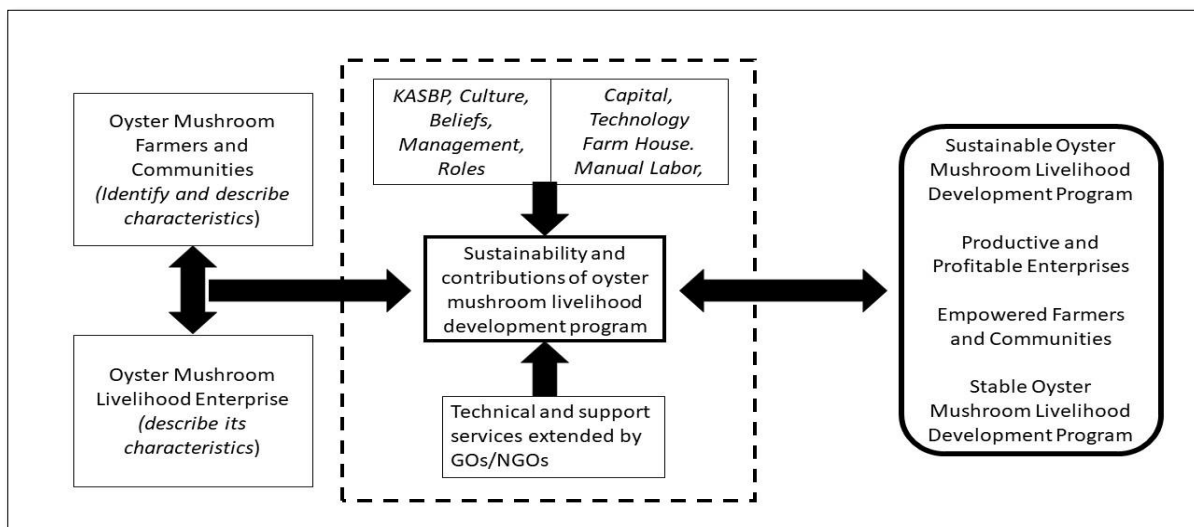

Figure 1. The different influencing factors of sustainability as determined in the different theories of rural community development

Conceptual Framework

This research was designed to analyze the conditions and situations of the oyster mushroom livelihood projects and communities in the identified research sites in Ilocos Sur. It is focused on two intertwined factors in relation to the factors of sustainability. This will be done through a case documentation and analysis of the four rural communities to determine further the appropriate sustainable mechanism and possible

Moreover, the interrelationship of factors in the sustainability of the oyster mushroom livelihood projects in the different rural communities were documented to help farmers, growers, enthusiasts and the interested individuals to have an additional or alternative source of income and production while they are engaging into a livelihood enterprise in obtaining a stable production and secured profit in a sustainable way.

Other factors such as the rural communities’ knowledge, attitude, skills, behavior, culture, roles and management or policy implementation are the important considerations to rural development and the whole community.

Sustainable Oyster Mushroom Livelihood Development Project for Rural Communities of Ilocos Sur

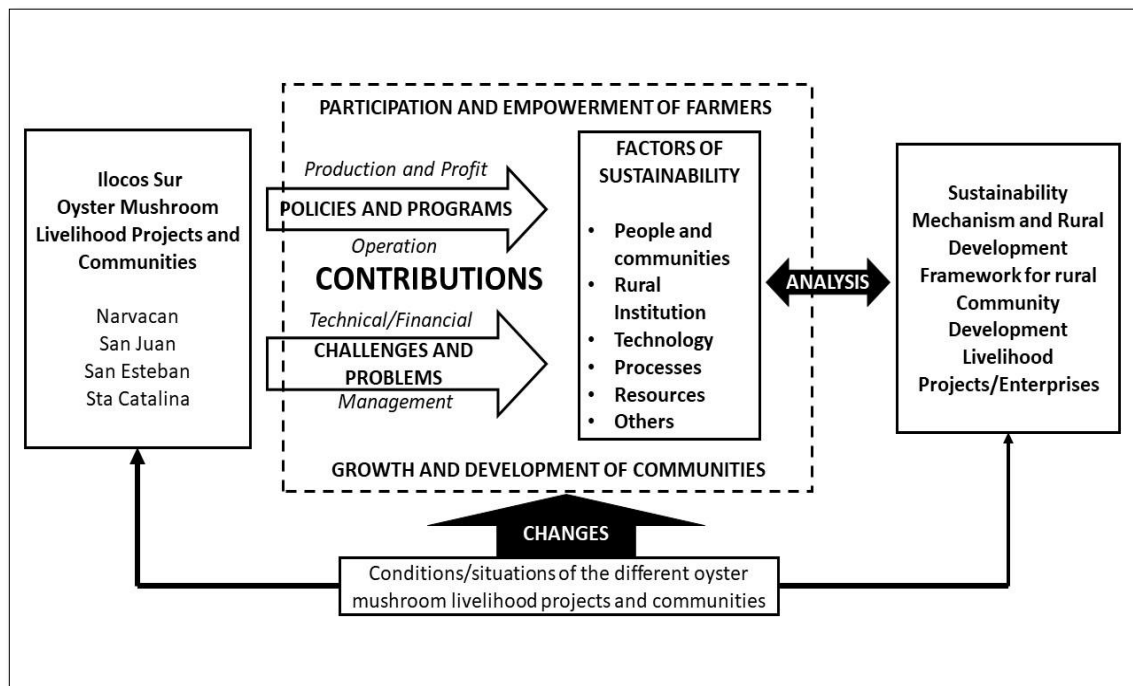

Figure 2. Research paradigm of the study.

Also, there is a need to consider the resources in the community such as capital, technology on oyster mushroom production, farm house and the labor force. The participation and empowerment of the stakeholders and the key players along with the support provided by the government and non-government offices and other institutions play also a vital role in order to meet sustainability of oyster mushroom livelihood development program.

There are also many challenges involve in oyster mushroom livelihood which can directly affect the sustainability of the development program such as inclusion of the business operation at the local level, delivery of the technical and financial support services by partner agencies and the management of the oyster mushroom production as a livelihood since it involves different key-players and stakeholders. With all these considerations, a sustainable oyster mushroom livelihood development project can be achieved looking into its productivity and profitability while farmers and communities are empowered and maintained the processes of sustainable development and rural community development.

Sustainable mushroom livelihood is a promising way to overcome challenges on food insecurity, malnutrition, and pollution. It is an efficient way for the utilization of agro-industrial wastes and ensures food security. It is also the easiest and cheapest source to address malnutrition and, it supports the local communities' economic activities through a sustainable mushroom livelihood development project. Hence, the economic and social condition of farmers can be improved by adding this commodity into their existing agricultural systems and livelihood activities.

METHODOLOGY

This chapter describes the methodology employed in the research study, the research design, locale of the study, population and sampling procedure, research instruments, data gathering procedure, statistical treatment and ethical considerations.

Research Design

The mix-methodology research approach was used in the study combining quantitative and qualitative methods. Specifically, the case analysis method was used to support the documentation and description of the oyster mushroom livelihood project activities. This was supported by qualitative and quantitative research methods in obtaining comprehensive understanding of specific situations and the different cases of each respondent and rural community.

Also, this research study formulated a sustainability mechanism and framework based on the activities of a government institution that creates and introduce new development process. The different processes include planning, development and validation and modification of the sustainability framework (investopedia.com/Kenton, 2022).

Sustainable Oyster Mushroom Livelihood Development Project for Rural Communities of Ilocos Sur

Locale of the Study

Figure 4 shows the location of the four municipalities in the province of Ilocos Sur, namely: Narvacan, San Esteban, San Juan and Sta. Catalina.

Narvacan is a second-class municipality with 34 barangays. It belongs to the second district of Ilocos Sur with a total population of 46,234 (2020). The main source of income is farming which includes rice, corn tobacco plus livestock and poultry. Fishing is another income source since Narvacan is situated near the coastline.

San Esteban is a 5th class municipality with a total population of 8,381 (2020). Farming and fishing are the main source of livelihood in the municipality with a farming system such as rice-corn/vegetables+fishing, rice-corn/tobacco+fishing.

San Juan, formerly named Lapog, belongs to the 3rd class municipality and has 26,674 total population according to the 2020 census. It is also called the Buri Capital of Ilocos Sur since they produce goods that are made of buri leaves. Rice is the main crop in the municipality followed by corn or garlic-onions and vegetables as added municipality commodities for production and profit. There are a few small-scale livelihood activities noted including oyster mushroom farming.

Sta. Catalina is a 5th class and the smallest among the 34 municipalities of Ilocos Sur in terms of land area but is the only one which has an urban status. It has 14,493 total population in 2020 census. Sta Catalina is just 4 kilometers away from Vigan City, the center of commerce and trade where most of the residents go and buy their households' needs and merchandise. Farming is the main source of households' income which include rice-corn/vegetables plus animal production. This also accounted Sta. Catalina as the vegetable bowl of the north because they are known for their cabbage, cauliflower and other prime vegetables sold in many markets especially in the Ilocos Province. Next to farming is fishing and small-scale businesses.



Figure 3. Map of the Province of Ilocos Sur Showing the Location of the Four Selected Municipalities as Research Sites. (Source: philatlas.com/luzon/r01/ilocos-sur.html)

Sustainable Oyster Mushroom Livelihood Development Project for Rural Communities of Ilocos Sur

Population and Sampling Procedure

The stakeholders who have contributed to the oyster mushroom livelihood such as the implementers from each selected local unit, the mushroom growers/farmers who established and utilized the oyster mushroom production technology, and the rural communities which adopted the technology and benefitted from it were the major entities in this research.

For this case analysis, a purposive sampling technique was employed. From the municipalities of Ilocos Sur, four were chosen based on the inclusion criteria where one respondent (1 mushroom grower) per selected municipality was interviewed.

Respondents from Narvacan, San Esteban, San Juan and Sta. Catalina were selected based from the inclusion criteria which includes attendance to trainings on oyster mushroom production, adoption of mushroom production technology; establishment of mushroom farm production area, and the number of production as either large farm area with 2000 fruiting bags and above which produces at least 10 kilograms of fresh mushrooms daily, (b) a minimal production farm area with 1000-2000 fruiting bags and produces at least 5-10 kilograms of fresh mushroom a day, and (c) a low production farm or a beginner with 100-1000 fruiting bags which produces at least 1-5 kilograms of fresh mushroom a day. Age range, sex/gender, civil status, educational attainment, and occupation are not included as criteria.

For the stakeholders from the government institutions include two respondents were from the DA-RFO I (1 Regional Technical Director and the project leader); three respondents from each selected municipalities (Municipal Mayor/Administrator, the Municipal Agriculturist and the project leader); five beneficiaries of the mushroom livelihood project or adopters of the production technology who also attended hands-on training on mushroom production.

Table 1. The distribution of respondents from the four selected municipalities of Ilocos Sur

Selected Municipalities	LGU	Mushroom Growers	Total Respondents
Narvacan	3	5	8
San Esteban	3	5	8
San Juan	3	5	8
Sta. Catalina	3	5	8

Research Instruments

There were two sets of research instruments used to gather data and information, namely the survey questionnaire and interview guide which was complemented by an interview checklist of questions administered personally or through face-to-face by the researcher. The rural community characteristics were documented including the different oyster mushroom livelihood projects which served as the cases analyzed in relation to sustainability and rural community development.

Data Gathering Procedure

When permission to administer a survey was obtained from the concerned authorities, the researcher distributed and administered the questionnaire to the respondents. It was also explained that their responses were treated with utmost confidentiality and was clearly defined that the respondents voluntarily provided their responses according to their knowledge, without coercion, and that they can withdraw anytime from the research study.

This research gathered primary data such as the lists of beneficiaries, project design support services and other necessary data and information regarding the oyster mushroom development project established. The face-to-face process of gathering information was done which facilitated a more comprehensive exchange of knowledge and ideas for each respondent.

An English survey questionnaire was prepared to collect pertinent data of the research. This was translated in Iloko language to facilitate an easier gathering of data from the farmer/owner. Prior to the formal conduct of the research, request letters to the concerned authorities were prepared to secure permission to conduct the research and to request for needed documents.

Statistical Treatment of Data

Data gathered were organized, tabulated, analyzed, and interpreted accordingly using the appropriate statistical tools such as frequency counts, percentage and weighted means were used in analyzing data on the contributions of stakeholders in terms of technical and financial support services and were presented in tables and matrices.

Sustainable Oyster Mushroom Livelihood Development Project for Rural Communities of Ilocos Sur

In analyzing the data gathered during the interview with the mushroom growers, the researcher used the thematic analysis and closely examined the data focusing on the details which helped the researcher in constructing insights and information based on how the data was used.

The challenges encountered by the respondents on the policy implementation (technical and financial) of the oyster mushroom livelihood project were measured through the degree of seriousness.

Ethical Considerations

Prior to the conduct of the research, the research process and ethical considerations were reviewed and evaluated by the MMSU's University Research Ethics Review Board (URERB).

The researcher assured the respondents that they and their responses were treated with utmost reverence, privacy, and confidentiality as specified in the letters of consent clearly stated on the defined voluntary participation of the respondents according to their knowledge, without any coercion and that they can withdraw anytime from the research study. Information about the institutional affiliation and other necessary information of the researcher were indicated in the request letter. No minors nor vulnerable groups were included as respondents in the research study.

The gathered data were treated with utmost confidentiality which were kept for six months as they were analyzed and interpreted. Such filled-up documents shall be destroyed after the printing of the book/manuscript.

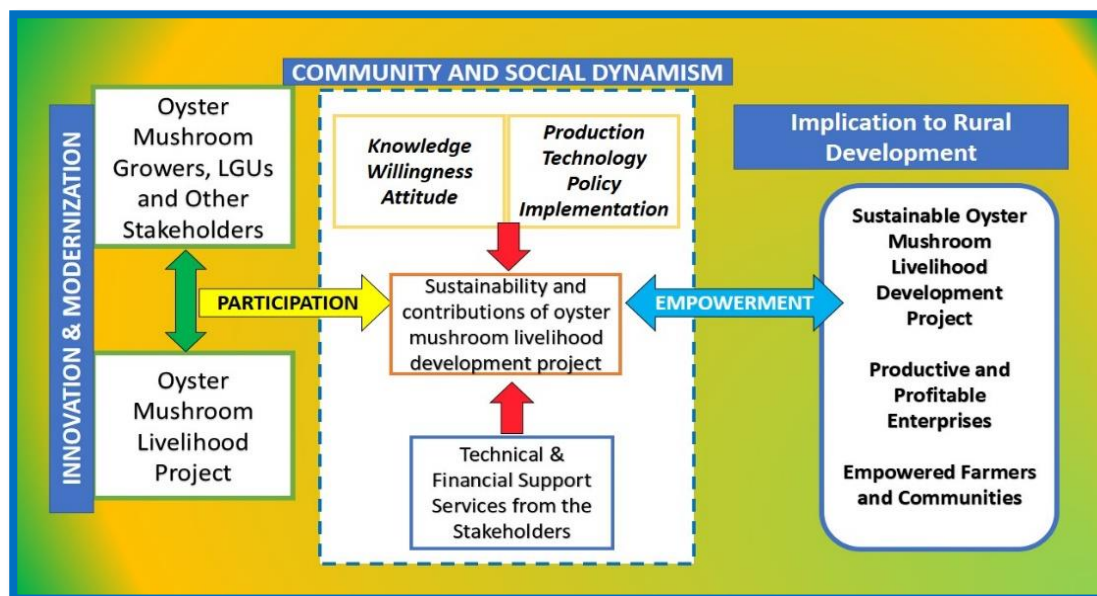

Figure 5. Reconceptualized framework of sustainability mechanisms and development framework showing the interrelationship of factors towards achieving sustainability of the oyster mushroom livelihood development project

SUMMARY, FINDINGS, CONCLUSION AND RECOMMENDATIONS

This chapter presents the summary, findings, conclusions drawn and recommendations which were based from the objectives, theoretical and conceptual frameworks of this research study.

Summary

Oyster mushroom livelihood project is one of the development projects of the Department of Agriculture RFO I that is implemented in collaboration with local government units to help farmers, growers, enthusiasts and the interested individuals to have an additional or alternative source of production and income while they are engaging into a livelihood enterprise of which they could obtain a production and profit that is sustainable for their household.

This research study was conducted to determine the contributions of the stakeholders of the oyster mushroom livelihood on the technical and financial services provided by the development institutions, the challenges met by the stakeholders in terms of knowledge, willingness and attitude and the policy implications towards the oyster mushroom livelihood, and the sustainability framework to address the challenges in sustaining the oyster mushroom livelihood project in Ilocos Sur.

A constructed survey questionnaire and interview guide were used in the data gathering which were collated and interpreted using frequency means, weighted means and through case analysis method.

Sustainable Oyster Mushroom Livelihood Development Project for Rural Communities of Ilocos Sur

Findings

Participation in terms of technical support according to the LGU. Narvacan responded that their participation as to technical support was highly participated implying that they have been doing their jobs as specified in their mandates just like the regional office because this livelihood project was coordinated to them for proper implementation. Specifically, there is high participation on the technical support in all activities of the mushroom livelihood project which include crafting of concepts, conducting consultation/seminars/meetings, promoting awareness and taking appropriate action on implementation issues, and on assisting and coordinating with the regional unit and other funding agencies on the implementation of the livelihood project.

San Esteban highly participated in almost all the indicators although the lowest mean was derived in terms of support to development initiatives and formalizing involvement of funding agencies and other stakeholders which means that the LGU moderately participated on these two indicators.

LGU San Juan has a very high participation in almost all the indicators which tends to suggest that they would participate to any development advocacies such as the mushroom livelihood project more so if an individual entity imply his intention to get support from their LGU.

Sta. Catalina participated very highly in terms of active participation in all the activities of the livelihood project but its involvement with funding agencies and stakeholders through a MOA obtained a moderate participation.

Generally as the table reveals, the respondents in San Juan indicated a high participation to the mushroom livelihood project as compared to Narvacan and San Esteban which have the lowest mean. In terms of variable mean, the highest was on the involvement in crafting the concepts of the oyster mushroom livelihood project. This implies that it was highly participated across all LGUs. And the lowest variable mean was in formalizing the involvement of funding agencies and other stakeholders through a MOA which was moderately participated implying that MOA is not necessary to the LGUs.

Participation in terms of Technical Support according to the Mushroom Growers. Looking at the mushroom growers responses that LGU Narvacan has a low participation in formalizing their involvement through a MOA with other funding agencies and stakeholders and in all activities of the livelihood project. This suggests that the mushroom growers were not able to receive the intended participation from the LGU.

This was different from that of the LGU San Esteban wherein mushroom growers said that they very highly participated in terms of all activities of the livelihood project. This suggests that San Esteban actually received support from their LGU. San Juan has a very high participation according to the mushroom growers implying that they have witnessed the LGUs dedication with their mandate which contributed to the attainment of the LGUs goal in implementing the mushroom livelihood project in San Juan.

In Sta. Catalina, mushroom growers said that their LGU moderately participated in all activities of the mushroom livelihood project which means that the LGU could probably cannot provide time to monitor or inspect their livelihood project.

Generally, mushroom growers said that LGU San Juan has a very high participation in terms of technical support to the oyster mushroom livelihood project. And the lowest mean was Narvacan. In terms of the variables, active participation in all activities and organizes/facilitates the conduct of consultations/seminars/meetings were the highest in variable mean which means that all the LGUs acknowledged the importance of conducting consultation/seminars and meetings with the stakeholders. The lowest mean was seen on the formalization of involvement of funding agencies and other stakeholders through a MOA. Across all the LGUs, this suggests that they do not prioritize crafting and signing a MOA as part of their undertakings.

Availability/Adequacy of financial support according to the LGUs. Local Unit of Narvacan said that their financial support were highly available/adequate through fund allocation and provision of logistics while all other indicators were moderately available/adequate. But a moderately available/adequate support was revealed in conducting promotional activities for the community-based oyster mushroom project,

In San Esteban the support from the LGU were highly available/adequate through allocation of funds, conducting hands-on training and other necessary seminar /lecture and serving as linkage between and among stakeholders. But all other indicators were moderately available/adequate such as on conducting hands-on training and other necessary seminar /lecture needed in the conduct /implementation of the project, setting up a feedback mechanism to facilitate flows of information, serving as linkage between and among stakeholders, supporting the continued development of the nationwide campaign of oyster mushroom's implementation and adoption, supporting the collaboration and partnership in the execution of projects, and monitoring and evaluating the implementation of the project.

Sustainable Oyster Mushroom Livelihood Development Project for Rural Communities of Ilocos Sur

Also, the local executives in San Juan provided a very highly available/adequate financial support. Sta. Catalina LGU said that their financial support were highly available/adequate in almost all indicators. But the financial support in the conduct of promotional activities was moderately available/adequate.

Generally, LGU-San Juan contributed the highest financial support to the oyster mushroom livelihood project while Narvacan has the lowest contribution. In terms of the variable, two were highly available/adequate. This implies that all the LGUs' financial support in conducting hands-on training and serving as linkage among stakeholders were highly available/adequate.

Availability/adequacy of financial support according to the mushroom growers. As revealed by the mushroom growers, LGU Narvacan provided their financial support moderately across all indicators. This would mean that the financial support participated by the LGU is sometimes unappreciated by the mushroom growers. This may be due to the fact that the latter is expecting more monetary allocation.

The mushroom growers in San Esteban said that LGU provided a very highly available/adequate financial support in terms of conducting promotional activities. And moderately available/adequate support for continuous development of nationwide campaign of the livelihood project, collaboration and partnership among stakeholders and in monitoring or evaluating the implementation of the project. These could be attributed to the significant change on the usual agricultural development priorities of the LGU in San Esteban.

Also revealed in LGU-San Juan a very highly available/adequate financial support as proven by the mushroom growers who benefitted from it. This was also seconded by the individual grower that without their financial support he was not able to start and establish their own livelihood. This would indicate that the LGU acknowledges the need of the mushroom growers as to establishing their own oyster mushroom livelihood. Also, it is the mandate of the LGU to support the development initiatives where they could offer their support in terms of funds.

Mushroom growers in Sta. Catalina said that LGU has provided a moderately available/adequate financial support. This signify the fact that growers were not satisfied with the financial support their LGU is providing. The mushroom growers being in an association expected more funds to be allocated for their livelihood project. But being an individual grower is more advantageous than that of being a recipient as stated by an individual grower.

Generally, San Juan has provided the highest financial support according to the mushroom growers while Narvacan obtained the lowest financial support. This denote that LGU San Juan is more supportive with their livelihood project. Narvacan could possibly prioritized other development project during the Covid pandemic

The challenges encountered by the stakeholders in terms of knowledge level of mushroom growers. Narvacan oyster mushroom growers were extremely knowledgeable which implies that the mushroom growers already tried and proven the attributes as they pursued oyster mushroom production as their livelihood. Same extreme ratings were garnered in San Esteban mushroom growers. Only that they were moderately knowledgeable on the presence of market linkages. Also, San Juan and Sta Catalina mushroom growers were extremely knowledgeable in all indicators.

Generally, Narvacan mushroom growers has the highest knowledge level and San Esteban has the lowest. Although all of the mushroom growers were extremely knowledgeable. In terms of variable mean, the highest was on the knowledge of the mushroom growers particularly knowing that this oyster mushroom production is a livelihood that can be adopted. The lowest variable means were on the knowledge that oyster mushroom livelihood is funded by the regional and local government; and market linkages are present. This implies that there were no challenges that encountered by the mushroom growers in all the municipalities. This could also mean that they were empowered growers with skills and knowledge in oyster mushroom farming. This was also explained by the Food and Agriculture Organization (fao.org) that a livelihood includes the capabilities and activities required for a means of living. This is said to be sustainable when it can cope with and recover from challenges and problems and maintain its capabilities and activities now and in the future.

The Willingness-related challenges encountered by the stakeholders. The mushroom growers of Narvacan, San Esteban, San Juan and Sta. Catalina were extremely willing in almost all the indicators.

San Esteban and Sta. Catalina were extremely willing in attending seminars, lectures and other activities. Both municipalities were also very willing to take the risk to pursue this livelihood

Generally, Narvacan has the highest rate in terms of willingness while San Esteban and Sta. Catalina has the lowest according to the mushroom growers. This implies that Narvacan were extremely willing to do all the indicators because they have already experienced the benefits of pursuing mushroom production as a livelihood and they wanted to be partners with the LGU to reach more people in the community and pay forward to other interested individuals. Across all variables, the willingness to

Sustainable Oyster Mushroom Livelihood Development Project for Rural Communities of Ilocos Sur

attend seminar/lectures and other activities was the highest variable mean and taking the risks to pursue the livelihood was the lowest.

Nevertheless, all of the mushroom growers in the four municipalities were extremely willing hence, this suggests that they would pursue their oyster mushroom livelihood. Also, this implies that there were no indication of any challenges.

The Attitude-related challenges encountered by the stakeholders The attitude of Narvacan were exposed as the mushroom growers strongly disagree that contamination is hard to prevent. This means that they attended a hands-on training so they knew already how to prevent contamination. Also, they extremely agree that this livelihood needs more laborers because it is a labor-intensive livelihood and needs adequate time and attention in order to sustain it. This also was extremely agreed by the San Esteban mushroom growers. They moderately agree that they lack technical know-how and no available source of spawn. These attitude of the growers in San Esteban greatly affects as to how they can sustain their livelihood.

San Juan fairly disagree that mushroom livelihood needs big facilities, hard to sell the produce, unaffordable by consumers, no available source of spawn and hard to prevent contamination. They moderately agree that it needs laborers because it is a labor-intensive livelihood. This could be attributed by the fact that they only produce minimal number of fruiting bags so they don't need many laborers yet.

Sta. Catalina extremely agree that this livelihood need adequate time and attention but strongly disagree that it does not need big facilities in order to produce oyster mushroom.

Generally, Narvacan has the lowest mean that they fairly disagree. This suggests that they have already the knowledge and capabilities of producing and managing their mushroom livelihood. San Esteban has the highest among the LGUs. They were very agree with the indicators which denotes that they have the knowledge already. They just need enhancement in order to prove more about the technology and management. But generally. Hence, no challenges encountered. Only on the issue of providing adequate time and attention in pursuing the mushroom livelihood because it is a labor-intensive technology.

Technical Challenges on policy implementation encountered by the stakeholders

The Ilocos Sur Local Government Unit

The DA-Region I said that they experienced very serious challenges which include availability of service vehicle to facilitate monitoring, record keeping and management. This implies that at their level, they experienced these problems very seriously. Considering the challenges encountered in oyster mushroom livelihood project, Narvacan and San Esteban were moderately serious according to the responses of the LGU on the area on interpersonal skills to interface with the different stakeholders. But for San Esteban it was a fairly serious problem. San Juan's stakeholders said that challenges encountered were generally not serious. Sta. Catalina encountered moderately serious problems in the policy implementation such as in the formulation of policies that are not aligned to the priority project and absence of feedback on the status of resolution/policies forwarded but records management were not serious problems to them.

Across the LGUs, Narvacan has the highest mean which encountered moderately serious problems while the lowest was San Juan which did not experienced serious challenges. This means that challenges were partners of every LGU because these served as motivations to them and as reference to do more with their development livelihood projects.

In terms of the variables, the following were the highest: knowledge/skills in the formulation of resolution & other policies regarding the conduct or implementation of oyster mushroom livelihood project, action on the policies/guidelines presented to concerned stakeholders, and feedback on the status of resolutions/policies/guidelines forwarded to stakeholders. The lowest was on record keeping and management. Technically, this implies that LGUs moderately experienced challenges which served as guidance for them to execute the project better.

Mushroom Growers

In Narvacan, mushroom growers encountered very serious problems of which these possibly affected their mindset of how policies should be implemented by their LGUs. San Esteban experienced very serious problems on the advocacy materials preparation and record keeping and management. They met moderately serious challenges on the updates on existing laws, ordinances and other policies and interpersonal skills to interface with the different stakeholders

But for the mushroom growers in San Juan, there were no serious problems so policies were implemented accordingly. Sta. Catalina experienced moderately serious problems All the rest of the variables were fairly serious.

Technically, mushroom growers in San Esteban has the most serious problems in terms of policy implementation while growers in San Juan said they did not seriously met challenges. In terms of the variables, action on the policies/guidelines presented to concerned stakeholders has the highest mean while the lowest mean were on the updates on existing laws, ordinances and other policies and interpersonal skills to interface with the different stakeholders. This implies that performances

Sustainable Oyster Mushroom Livelihood Development Project for Rural Communities of Ilocos Sur

in terms of technical policies differs from each LGU since they have different priorities and strategies in implementing their policies. Also implies that the mushroom growers failed to appreciate the implementation strategies of the LGUs.

Financial Challenges on policy implementation encountered by the stakeholders

Ilocos Sur Local Government Units

In Narvacan, they encountered moderately serious challenges. San Esteban said all were moderately serious but a fairly serious challenge was on being initiative to source-out funds.

San Juan also experienced fairly serious challenge on the reliance to the support of funding agencies and other stakeholders. They were not seriously challenged on the preparation of plan and guidelines to utilize funds sourced-out from other agencies and other stakeholders, allocation of funds in conducting meetings/discussions and for monitoring activities. These policies have been implemented smoothly in San Juan since they were very supportive from the start of the project. In Sta. Catalina, all variables were fairly serious and only one was not serious in terms of allocation of funds for monitoring activities.

This study also revealed that the LGUs have encountered varied challenges as to policy implementation on the area of technical and financial policies. LGUs and the mushroom growers revealed that they encountered very serious challenges. These include the knowledge/skills in the formulation of resolution & other policies regarding the conduct or implementation of oyster mushroom livelihood project, action on the policies/guidelines presented to concerned stakeholders, alignment of formulated policies/ guidelines to the priority projects, Feedback on the status of resolutions/policies/guidelines forwarded to stakeholders, access to information regarding the resolution/policies/guidelines, social marketing skills to conduct advocacy activities, advocacy materials preparation, information on the existing projects of the regional and local units, availability of service vehicle to facilitate monitoring, and record keeping and management.

Across the variables, cooperation among the stakeholders to seek additional funds and preparation of plan and guidelines to utilize the funds as sourced-out from other agencies and other stakeholders were the two variables with the highest mean but these were fairly serious problems.

Mushroom Growers

Narvacan mushroom growers experienced very serious problem on the reliance of LGUs on the support of funding agencies and other stakeholders while all other indicators were moderately serious. San Esteban mushroom growers encountered a very serious problem on the initiative to source-out funds while all other indicators were moderately serious. In San Juan, mushroom growers did not encounter any serious problem. Sta. Catalina experienced fairly serious problems on the reliance on the support of funding agencies and other stakeholders, initiative to source-out funds and cooperation among the stakeholders to seek additional funds according to the mushroom growers.

On the area of financial support as to policy implementation, the DA-RFO I encountered a very serious challenge specifically on the allocation of funds for monitoring activities. Generally, mushroom growers in San Esteban has the highest weighted mean and San Juan has the lowest. The LGUs also encountered moderately serious problems which include reliance on the support of funding agencies and other stakeholders, initiative to source-out funds, cooperation among the stakeholders to seek additional funds, preparation of plan and guidelines to utilize the funds as sourced-out from other agencies and other stakeholders, allocation of funds in conducting meetings/discussions, and allocation of funds for monitoring activities. This would mean that efforts have been made by the LGUs to improve their commitments and their mutual accountability and transparency in delivering tangible services aligned with their priorities but undoubtedly the mushroom growers were unconvinced and they want more.

CONCLUSION

Based on the findings, the conclusions were drawn according to the objectives of the research study.

As prevailed in the research study, the contributions of the stakeholders of the oyster mushroom livelihood were the following:

On technical services; the LGUs participation include crafting concepts, conducting consultation/seminars/meetings, promoting awareness, and taking appropriate action on implementation issues, and on assisting and coordinating with the regional unit and other funding agencies on the implementation of the livelihood project.

But low participation in the support of development initiatives of the mushroom livelihood project and formalizing involvement of funding agencies and other stakeholders through an MOA.

On financial services, LGUs provided fund allocation and provision of logistics for the mobilization of the implementers, conducts hands-on training and other necessary seminar /lecture needed in the conduct /implementation of the project, and

Sustainable Oyster Mushroom Livelihood Development Project for Rural Communities of Ilocos Sur

serve as a linkage between and among stakeholders. But moderately provided support in conducting hands-on training and other necessary seminar /lecture needed in the conduct /implementation of the project, setting up a feedback mechanism to facilitate flows of information, serving as a linkage between and among stakeholders, supporting the continued development of the nationwide campaign of oyster mushroom's implementation and adoption, supporting the collaboration and partnership in the execution of projects, and monitoring and evaluating the implementation of the project.

On the knowledge, willingness, and attitude of mushroom growers, there were no challenges encountered.

On policy implementation, LGUs have encountered varied challenges to policy implementation in the area of technical policies. These include the knowledge/skills in the formulation of resolution & other policies regarding the conduct or implementation of the oyster mushroom livelihood project, action on the policies/guidelines presented to concerned stakeholders, alignment of formulated policies/ guidelines to the priority projects, feedback on the status of resolutions/policies/guidelines forwarded to stakeholders, access to information regarding the resolution/policies/guidelines, social marketing skills to conduct advocacy activities, advocacy materials preparation, information on the existing projects of the regional and local units, availability of service vehicle to facilitate monitoring, and record-keeping and management.

On the area of financial policies, the DA-RFO I encountered a very serious challenge specifically on the allocation of funds for monitoring activities. The LGUs also encountered problems which include reliance on the support of funding agencies and other stakeholders, initiative to source-out funds, cooperation among the stakeholders to seek additional funds, preparation of plan and guidelines to utilize the funds as sourced-out from other agencies and other stakeholders, allocation of funds in conducting meetings/discussions, and allocation of funds for monitoring activities.

Hence, participation to technical and financial services plus the strategies in policy implementation of the LGUs are very important contributions to attain sustainability of livelihood project along with the knowledge, willingness, and attitude of the mushroom growers.

Implication to rural development. Oyster mushroom livelihood project in Ilocos Sur is not yet sustainable based on the findings of the research. Evidences were the low participation of stakeholders as to technical and financial support services. Also, the four municipalities depict only themselves so the sustainability mechanisms and development framework were applicable only to the four LGUs and can only be utilized by them.

Since the researcher focused only on the technical, financial, and social aspects of the mushroom livelihood project, there were no wider perspectives as to the scope of the research is concerned.

The economic aspect such as value-chain analysis should be reviewed to have a wider picture of what mushroom program/project is doing now in Ilocos Sur. LGUs must have the capacities to manage their participation in the implementation of livelihood projects which are very important contributions to plan, implement, monitor and evaluate these projects to perform analysis and transform the lives of the rural communities.

LGUs could provide the ideal, authority, infrastructure, policy and planning procedures to maximize the benefit for its communities. LGUs play a major role in a community's development, provide the links between the people and government, address its community's problems and concerns, enforce policies and hold influence over its communities. The LGUs are also intermediaries in channeling the framework of government into each individual community in order to create a beneficial outcome.

RECOMMENDATION

Sustainable livelihood on oyster mushroom help address concerns on food security, regular source of productivity and employment. Hence, the sustainability mechanisms and development framework on oyster mushroom livelihood development project is hereby generally recommended for the four LGUs as the research sites. Sustainable livelihood can help achieve rural community development through participation and empowerment of the stakeholders by:

1. Sustaining provision of technical support services which will include hands-on trainings, value-adding of produce, local and international market opportunities and values formation; increasing guidance and mentoring during consultative meetings and round table discussions;
2. Enhancing partnership and linkages and formalizing involvement among the stakeholders and legitimize through a MOA;
3. Increasing funds support for monitoring and evaluation purposes and provision of logistics;
4. Empower local implementers, facilitators and coordinators by providing incentives and recognition;
5. Refining planning and execution of guidelines in sourcing-out and utilization of funds;
6. Increase provision of advocacy material and awareness seminar;

Sustainable Oyster Mushroom Livelihood Development Project for Rural Communities of Ilocos Sur

7. Increase the opportunities of the beneficiaries, end-users or the rural community's involvement in policy formulation in order to determine and address their real need to pursue livelihood; and
8. Encourage the participation of other significant stakeholders such as the academe and the NGOs while expanding the number of beneficiaries to reach more people in the community.
9. Further research study is recommended to include the processing and marketing aspects of the oyster mushroom livelihood project while validating and evaluating the developed sustainability mechanism and rural community livelihood framework.

REFERENCES

- 1) Acosta, P.A., & Avalos, J. (2018). *The Philippines Sustainable Livelihood Program: Providing and expanding access to employment and livelihood opportunities*. World Bank Social Protection Policy Note 13. <https://documents1.worldbank.org/curated/en/385601527673449057/pdf/The-Philippines-Sustainable-Livelihood-Program-providing-and-expanding-access-to-employment-and-livelihood-opportunities.pdf>
- 2) Aguilar, C.H., Barbosa, J.R., Zapico, F.L., & Flamiano, R.S. (2010). Growth and yield performance of oyster mushroom (*Pleurotus ostreatus*) feeding on different agro-industrial wastes. *USM R&D Journal*, 18(1):18-30.
- 3) Akande, O. A., Akande, K. P., Rowland, V. & Olusina, O. P. (2023). Contributions of IKOGOSI Warm Springs to Poverty Alleviation in Ikogosi Community, Ekiti State, Nigeria. <https://www.researchgate.net/publication/367114336>
- 4) Andam, C., & Dulay, H. (2014, December 14). A treasure from waste. *The Philippine Star*. <https://www.philstar.com/othersections/starweekmagazine/2014/12/14/1402303/treasure-waste>
- 5) Angell, Beth. (2013 June). Behavioral Theory. <https://doi.org/10.1093/acrefore/9780199975839.013.30>
- 6) Asian Development Bank (2018 July). Strategy 2030: Achieving a Prosperous, Inclusive, Resilience, and Sustainable Asia and the Pacific. ADB's Operational Priorities.
- 7) Atkin, C.K., & Rice, R.E. (2013). Theory and principles of public communication campaigns. In *Public communication campaigns*. SAGE Publications, Inc. https://www.sagepub.com/sites/default/files/upm-binaries/46948_CH_1.pdf
- 8) Balan, V., Zhu, W., Krishnamoorthy, H., Benhaddou, D., Mowrer, J., Husain, H., & Eskandari, A. (2022). Challenges and opportunities in producing high-quality edible mushrooms from lignocellulosic biomass in a small scale. *Applied microbiology and biotechnology*, 106(4), 1355–1374. <https://doi.org/10.1007/s00253-021-11749-2>
- 9) Bhuiyan, A.B., Chamhuri, S., Ismail, Abdul G., & Islam, M.A. (2012). Microfinance and sustainable livelihood: A conceptual linkage of microfinancing approaches towards sustainable livelihood. *American Journal of Environmental Sciences*, 8, 328-333.
- 10) Blogger (2018). Importance of understanding community dynamics and community action. <https://www.google.com/search?sa=X&nirf=community+and+social+dynamicshttp://rjtadle.blogspot.com/2018/11/importance-of-understanding-community>
- 11) Birkmann, J., E. Liwenga, R. Pandey, E. Boyd, R. Djalante, F. Gemenne, W. Leal Filho, P.F. Pinho, L. Stringer, and D. Wrathall (2022). Poverty, Livelihoods and Sustainable Development. In: *Climate Change 2022: Impacts, Adaptation and Vulnerability. Contribution of Working Group II to the Sixth Assessment Report of the Intergovernmental Panel on Climate Change*. Cambridge University Press, Cambridge, UK and New York, NY, USA, pp. 1171–1274, doi:10.1017/9781009325844.010. Cairns Mushrooms Australia. (n.d.). Nutrition. <https://www.cairnsmushrooms.com.au/nutrition.html>
- 12) Bova, D. M. and Lin, C. (Reviewing Editor) (2022). A vocabulary for sustainability, *Sustainable Environment*, 8:1, doi: 10.1080/27658511.2022.2113542
- 13) Boyatzis, Richard E. (2019). Competencies as a Behavioral Manifestation of Implicit Motives. <https://www.researchgate.net/publication/286056552>
- 14) Brosas, Arturo (2023). Mushroom Farming in the Philippines: How to Grow and Cultivate Mushroom. <https://agrario.com/agriculture/mushroom-farming-in-the-philippines/>
- 15) Center for Design and Research in Sustainability. (n.d.). *Sustainability framework overview*. <http://cedarscenter.com/sfoverview.cfm>
- 16) Chakravarty, Satya R. (2017) Analyzing Multidimensional Well-Being: A Quantitative Approach. A Synthesis of Multidimensional Poverty. <https://doi.org/10.1002/9781119257424.ch3>
- 17) Chambers, R., and Conway, G.R. (1991). Sustainable rural livelihood: practical concepts for the 21st century. Institute of Development Studies Discussion Paper 296. Cambridge.

Sustainable Oyster Mushroom Livelihood Development Project for Rural Communities of Ilocos Sur

- 18) Chang, H.Y., Jeon, S.W., Cosadio, A.L., Icalina, C.L., Panganiban, R., Quirino, R.A., & Song, Y. (2014). Status and prospect of mushroom industry in the Philippines. *JPAIR Multidisciplinary Research*, 16, 1-6.
<https://doi.org/10.7719/jpair.v16i1.268>
- 19) Chiang, F.F., & Birtch, T.A. (2010). Pay for performance and work attitudes: The mediating role of employee-organization service value congruence. *International Journal of Hospitality Management*, 29(4), 632-640.
<https://doi.org/10.1016/j.ijhm.2009.11.005>
- 20) Cook, Rob. (2023 May 26). Ranking of States that Produce the Most Mushrooms. NASS/USDA 2022.
- 21) Da Silva Junior, A. (2020). Sustainable livelihood approach <https://www.linkedin.com/pulse/>
- 22) Dar, W.D. (2020). Implementing guidelines for the Urban Agriculture Program under Republic Act No. 11494 or the “Bayanihan to Recover as One Act.” *Republic of the Philippines Office of the Secretary Memorandum Circular No. 42*.
https://www.da.gov.ph/wp-content/uploads/2020/12/mc42_s2020.pdf
- 23) Dela Rosa, M. G. (2013) A three-year strategic plan for sustained countryside agricultural and fishery development in Region I. (Unpublished)
- 24) Department for International Development. (1999, April). *Sustainable livelihoods guidance sheets*. Emergency Nutrition Network. <https://www.enonline.net/attachments/872/section2.pdf>
- 25) Department of Environment and Natural Resources. (1990). *Philippine strategy for sustainable development part 1: A conceptual framework*. The World Bank. <https://agris.fao.org/agris-search/search.do?recordID=US2012402347>
- 26) De Silva, N. & Wijeratne, M. (2021). Achieving Community Development through Agricultural Extension Programme: Technology Dissemination for Mushroom Farmers. <https://jl4d.org/index.php/ejl4d/article/view/481/651>
- 27) Dinh, T.P., Cameron, D., & Nguyen, X. (2015). Rural livelihood adoption framework: A conceptual and analytical framework for studying adoption of new activities by small farmers. *International Journal of Agricultural Management* 4(4). <https://doi.org/10.22004/ag.econ.262380>
- 28) Doodoo, J.K. (2018). Livelihood dynamics in tropical drylands: Mixed farming, water management and market integration in Laikipia, Kenya. *Mountain Research and Development* 38(1), 92-93. <https://doi.org/10.1659/mrd.mm218>
- 29) Freire, F.M., and Lima, Dc.b.p. (2018). The 1960s Modernization Theory Updated: The Role of the Evaluative State in Today’s Brazilian Education. *Universal Journal of Educational Research* 6(10): 2373-2378, 2018 <http://www.hrpub.org> DOI: 10.13189/ujer.2018.061036
- 30) Food and Agriculture Organization. (2021). Status and trends in world mushroom production-III –World production of different mushroom species in 21st century <https://agris.fao.org/agris-search/search.do?recordID=IN2022016137>
- 31) Food and Agriculture Organization. (2014). Building a common vision for sustainable food and agriculture: principles and approaches. <https://www.fao.org/3/i3940e/i3940e.pdf>
- 32) Foreign Commonwealth and Development Office (2020). *Sustainable livelihoods guidance sheets*.
<https://www.gov.uk/government/organisations/department-for-international-development>
- 33) Gautam, Y., and Andersen, P. (2016 April) Rural livelihood diversification and household well-being: Insights from Humla, Nepal. *Journal of Rural Studies*. Volume 44, pages 239-249. <https://doi.org/10.1016/j.jrurstud.2016.02.001>
- 34) Glen, S. (n.d.). *Research methods: Qualitative research and quantitative research*. StatisticsHowTo.com: Elementary Statistics for the rest of us! <https://www.statisticshowto.com/research-methods-qualitative-research-and-quantitative-research/>
- 35) Halton, Clay. (2021 November 21). Diffusion of Innovations Theory: Definitions and Examples. Reviewed by Robert C. Kelly. <https://www.investopedia.com/terms/d/diffusion-of-innovations-theory.asp#:~:text=The-diffusion-of-innovations-theory-describes-the-pattern-and-speed,-late-majority-and-laggards.>
- 36) Hamm, S.R. (n.d.) *The future of mushroom production in the United States: Fewer producers and expanding output*. Migration Dialogue. https://migration.ucdavis.edu/cf/more.php?id=145_0_2_0
- 37) Heshmati, A., Maasoumi, E., & Wan, G. (2015). Asian Development Bank. *Economic Studies in Inequality, Social Exclusion and Well-Being*. (eBook) DOI 10.1007/978-981-287-420-7 Library of Congress Control Number: 2015930204. ISSN 2364-107X ISSN 2364-1088 (electronic)
- 38) Irene, C., David, J., & Willis, O. (2017). Assessment of factors influencing smallholder farmers adoption of mushroom for livelihood diversification in Western Kenya. *African Journal of Agricultural Research*, 12, 2461-2467.
<https://doi.org/10.5897/AJAR2017.12397>
- 39) Javier, Marizina B. (2019). Oyster mushroom production pushed in Region 1. *Agriculture Magazine*. DOST-PCAARRD S&T MediaService, Farmnews. <https://www.agriculture.com.ph/2019/12/28/oyster-mushroom-production-pushed-in-region-1/>

Sustainable Oyster Mushroom Livelihood Development Project for Rural Communities of Ilocos Sur

- 40) Jones, M. (1979). Training practices and learning theories. *Journal of European Industrial Training*, 3(7), 22-25. <https://doi.org/10.1108/eb002331>
- 41) Kawamura, Y. (2019). Demographic characteristics for sustainability.
- 42) Kelton, Will (2022). Research and Development (R&D), Definition, Types and Importance. (<https://www.investopedia.com/terms/r/randd.asp#toc-understanding-research-and-development-rd>)
- 43) Ketprapakorn, N., & Kantabutra, S. (2019 July). Sustainable Social Enterprise Model: Relationships and Consequences. Economic and Business Aspects for Sustainability. *Journal for Sustainability* 2019, Volume 11(14), 3772 <https://doi.org/10.3390/su11143772>
- 44) Kumla, J., Suwannarach, N., Kanaporn, S., Penkhrue, W., Kakumyan, P., Jatuwong, K., Vadthananarat, S., & Lumyong, S. (2020). Cultivation of Mushrooms and their Lignocellulolytic Enzyme Production through the Utilization of Agroindustrial Wastes 25(12), 2811; <https://doi.org/10.3390/molecules25122811>
- 45) Kusriani, N., Sulistiawati, R., & Imelda, I. (2019 March). Priority Factors in the Development of Sustainable Oyster Mushroom Agribusiness. *Jurnal Manajemen dan Agribisnis* 6 (1). DOI:10.17358/jma.16.1.86
- 46) Leeuwis, Cees. (2021). Rethinking Adoption and Diffusion as a Collective Social Process: Towards an Interactional Perspective. A Chapter of the Innovation Revolution in Agriculture: A Roadmap to Value Creation. Edited by Hugo Campos. *International Potato Center, Lima Peru*. <https://link.springer.com/book/10.1007/978-3-030-50991-0>
- 47) Loison, Sarah A. (2015 August). Rural livelihood diversification in Sub-Saharan Africa: A Literature review. *Journal for Development Studies*. DOI:10.1080/00220388.2015.1046445
- 48) London Premiere Centre. (2022) Lewin's Change Management Model: 2022. UK Training Provider. <https://www.lpcentre.com/articles/lewins-change-management-model2022-Kurt-Lewin-developed-change-restructures-and-new-product-launches>.
- 49) Mc Gregor, Douglas M. (160). Theory X and Theory Y. https://en.wikipedia.org/wiki/Theory_X_and_Theory_Y#:~:text=Theory-X-explains-the-importance,approach-tasks-without-direct-supervision.
- 50) Marquez-Ramos, L. & Mourelle, E. (2019). Education and economic growth: an empirical analysis of nonlinearities. *International Journal of Applied Economic Analysis*. Volume 27 Issue 79 <https://www.emerald.com/insight/content/doi/10.1108/AEA-06-2019-0005/full/html>
- 51) Medenilla, V. (2020 September 3). Mushroom farming can provide you with a sustainable income. *Agriculture Magazine*. <https://www.agriculture.com.ph/2020/09/03/mushroom-farming-can-provide-you-a-sustainable-income/>
- 52) Mensah, Justice Tei & Ricart Casadevall, Sandra (Reviewing editor) (2019). Sustainable development: Meaning, history, principles, pillars, and implications for human action: Literature review, *Cogent Social Sciences*, 5:1, DOI: 10.1080/23311886.2019.1653531
- 53) Miller, Rebecca. (2015 January). Roger's Innovation Diffusion Theory (1962, 1995). DOI:10.4018/978-1-4666-8156-9.ch016
- 54) Mina, J.C., Campos, R.B., Jr., Santiago, J.M., & Navarro, E.C. (2020). Mushroom production as a source of livelihood for the depressed barangay in Nueva Ecija, Philippines: A strategic plan using Tows Matrix. *International Journal of Disaster Recovery and Business Continuity*, 11(3), 3113-3121.
- 55) Morse, S., & McNamara, N. (2013). The theory behind the sustainable livelihood approach. In: *Sustainable livelihood approach: A critique of theory and practice*. Springer. https://doi.org/10.1007/978-94-007-6268-8_2
- 56) Moxley, A., Ebel, R., Cripps, C., Austin, C.G., Stein, M. and Winder, M. (2022 October 3). Barriers and Opportunities: Specialty Cultivated Production in the United States. *Sustainability Journals* 2022, 14(19), 12591; <https://www.mdpi.com/2071-1050/14/19/12591>
- 57) Ndhlovu, Emmanuel. (2018). Relevance of sustainable livelihood approach in Zimbabwe's Land Reform Programme. *Africa Insight*, 4(7), 83-98. <https://www.ajol.info/index.php/ai/article/view/178024>
- 58) National Economic Development Authority (NEDA). (2018). <https://www.google.com/search?q=philippine+development+plan+2017+to+2022&oq=philippine+development+plan&aqs=chrome.2.69i57j0i512i9.12472j0j4&sourceid=chrome&ie=UTF-8>
- 59) National Research Center Canada. (2019). Behavioral competencies: Management services. <https://nrc.canada.ca/en/corporate/careers>

Sustainable Oyster Mushroom Livelihood Development Project for Rural Communities of Ilocos Sur

- 60) Niazi, A.R., & Ghafoor, A. (2021). Different ways to exploit mushrooms: A review. *All Life*, 14(1), 450-460. <https://doi.org/10.1080/26895293.2021.1919570>
- 61) Odero, K.K. (n.d.). *Extending the sustainable livelihoods framework*. <https://citeseerx.ist.psu.edu/viewdoc/download?doi=10.1.1.125.4847&rep=rep1&type=pdf>
- 62) Omar, A.R.C., Ishak, S., Moen, J.A., & Arshad, M.M.A. (2013 April). Sufficient and Sustainable Livelihood via Community Economy: A case of Natural Farming Program in East Malaysia. *Asian Social Science*, 9 (5) DOI:10.5539/ass.v9n5p110
- 63) Ongoche, Christine Irene. (2019). AN Assessment of factors influencing smallholders farmers' willingness to adopt mushroom production for livelihood diversification in Vihiga County, Kenya. Department of Agricultural Economics. <http://erepository.uonbi.ac.ke/bitstream/handle/11295/107758/Ongoche>
- 64) Oyeleke O. J. and Dauda, R. (2021). Poverty and Inequality: The Challenges to Sustainable Development in Nigeria. *Ilorin Journal of Economic Policy*, 8(2) pages 1.-16. Department of Economics, University of Ilorin
- 65) Philippine Development Plan 2017-2022 overall framework. In *Philippine Development Plan 2017-2022*. <https://pdp.neda.gov.ph/wp-content/uploads/2017/01/Chapter-4-3292017.pdf>
- 66) Physiopedia. (n.d.) *Sustainable development goals*. Retrieved from https://www.physio-pedia.com/Sustainable_Development_Goals - cite_ref-3
- 67) Pomeroy, R., Ferrer, AJ. dG., & Pedrajas, J. (2017 July). An analysis of livelihood projects and programs for fishing communities in the Philippines. DOI:10.1016/j.marpol.2017.04.008
- 68) Prabhakar, S., Prabhakar, P., Kala, S. and Banerjee, M. (2021 July). Post-training Knowledge and Attitude Assessment of the Women Entrepreneurs towards Mushroom Cultivation. *International Journal of Agriculture Environment and Biotechnology* 14(2):229-234 DOI:10.30954/0974-1712.02.2021.17
- 69) Priya, R. (n.d.). The Max Weber's Theory of Social Action. <https://www.yourarticlelibrary.com/sociology/the-max-webers-theory-of-social-action/43752Action-Social-Weber-says-is-oriented-towards-their-behaviour>.
- 70) Raut, J.K. (2019). Current status, challenges and prospects of mushroom industry in Nepal. *International Journal of Agricultural Economics*, 4(4), 154-160. <https://doi.org/10.11648/j.ijae.20190404.13>
- 71) Rehman, A., Ghafoor, A. and Niazi, A. R. (2021 MAy). Different ways to exploit mushrooms: A review. doi:10.1080/26895293.2021.1919570
- 72) Royse, D.J., Baars, J., & Tan, Q. (2017). Current overview of mushroom production in the world. In C.Z. Diego & A. Pardo-Giménez (Eds.), *Edible and medicinal mushrooms: Technology and applications* (pp. 5-14). John Wiley & Sons Ltd. <https://doi.org/10.1002/9781119149446.ch2>
- 73) Rubiyanto, C.W., & Hirota, I. (2021). A review on livelihood diversification: Dynamics, measurements and case studies in montane mainland Southeast Asia. *Reviews in Agricultural Science*, 9, 128-142. https://doi.org/10.7831/ras.9.0_128
- 74) Salvador, M., & Sancho, D. (2021). The Role of Local Government in the Drive for Sustainable Development Public Policies. An Analytical Framework Based on Institutional Capacities. *Sustainability*, 13(11), 5978. MDPI AG. Retrieved from <http://dx.doi.org/10.3390/su13115978>
- 75) Seccareccia, M., & Correa, E. (2014). Celso Furtado and Development Theory. *International Journal of Political Economy*, 43(4), 3-6. <https://doi.org/10.1080/08911916.2014.1002678>
- 76) Shahi, V., Shahi, B., Kumar, V., Singh, KM., and Kumari, P. (2018). Impact study on mushroom cultivation for micro entrepreneurship development and women empowerment. *Journal of Pharmacognosy and Phytochemistry* 2018; SP4: 01-04.
- 77) Stoddart, H. (Ed.) (2011). *A pocket guide to sustainable development governance*. Stakeholder Forum.
- 78) Sustainable Development. *Sustainable Development Goals Platform*. Archived at <https://sustainabledevelopment.un.org/resourcelibrary>
- 79) Sustainable Livelihood Support Office. (1999).
- 80) Taculao, P.B. (2020, October 28). Community-based mushroom production and processing, part 1: A background on mushrooms and its health benefits. *Manila Bulletin*. <https://old.mb.com.ph/2020/10/28/community-based-mushroom-production-and-processing-part-1-a-background-on-mushrooms-and-its-health-benefits/>
- 81) Tecson, Z. (2020, July 30). *DA steps up mass mushroom propagation in Central Luzon*. Philippine News Agency. <https://www.pna.gov.ph/articles/1110618>
- 82) Thakur, M.P. (2020). Advances in mushroom production: key to food, nutritional and employment security: A review. *Indian Phytopathology* 73, 377–395. <https://doi.org/10.1007/s42360-020-00244-9>
- 83) *The 2019 Voluntary National Review of the Philippines: Review of the Status of the Implementation of the Sustainable Development Goals in the Philippines Focusing on Empowering People and Ensuring Inclusiveness and Equality*. United Nations.

Sustainable Oyster Mushroom Livelihood Development Project for Rural Communities of Ilocos Sur

- https://sustainabledevelopment.un.org/content/documents/23366Voluntary_National_Review_2019_Philippines.pdf
- 84) The Global Challenge for Government Transparency: The Sustainable Development Goals (SDG) 2030 Agenda. (n.d.). *World Top 20 Project Education Network*.
https://worldtop20.org/globalmovement?gclid=EAlaIqObChMlz5Pb98rs8wIVAmoqCh1fVgTZEAYASAAEgLnNvD_BwE
- 85) Toye, J. (2017). *The Many Faces of Socioeconomic Change*. Accessed publication on May 18, 2023. Oxford University Press. <https://library.oapen.org/bitstream/handle/20.500.12657/61408/1/9780198723349.pdf>
- 86) Unger, Roberto M. (2014). *The Religion of the Future: struggling with the world*.
<https://quotepark.com/authors/roberto-mangabeira-unger/quotes-about-life/>
- 87) United Nations. (n.d.). *3: Ensure healthy lives and promote well-being for all at all ages*.
<https://sdgs.un.org/goals/goal3>
- 88) United Nations. (n.d.). *Our work on the Sustainable Development Goals in Philippines*.
<https://philippines.un.org/en/sdgs>
- 89) United Nations. (n.d.). *The Sustainable Development Agenda*.
<http://www.un.org/sustainabledevelopment/development-agenda>
- 90) United Nations Development Programme. (2021). *UNDP Annual Report 2021*.
<https://www.undp.org/publications/undp-annual-report-2021>
- 91) United Nations Economic Commission for Europe. (2017). Department of Economic and Social Affairs. *Sustainable Development*.<https://sdgs.un.org/un-system-sdg-implementation/united-nations-economic-commission-europe-unece-24538>
- 92) United Nations Sustainable Development Summit. (2015). *Sustainable Development Goals Platform*. Archived at <https://sustainabledevelopment.un.org/post2015/summit>
- 93) Villoriente, C.M. (2019, November 29). *Mushroom Production Strategies Showcased in Free Seminar*. Department of Agriculture Agricultural Training Institute.
<https://ati.da.gov.ph/archives/ati-main/?q=news/01092020-1644/mushroom-production-strategies-showcased-free-seminar>
- 94) Vinita Rajput, & Ravika. (2020). Upliftment of Rural Livelihood with Advanced Production Technology of Oyster Mushrooms. *Int. J. Curr. Microbiol. App. Sci.*, 9(03), 1804-1813. <https://doi.org/10.20546/ijcmas.2020.903.209>
- 95) Wendi, D., Wacoo, A. P., and Wise, G. (2019 December 12). Identifying indigenous practices for cultivation of wild saprophytic mushrooms: responding to the need for sustainable utilization of natural resources. *Journal of ethnobiology and ethnomedicine*, 15(1), 64. <https://doi.org/10.1186/s13002-019-0342-z>
- 96) Wojciechowski, E., Pearsall, T., Murphy, P., & French, E. (2016). A case review: Integrating Lewin's theory with Lean's system approach. *Online J Issues Nurs*, 21(2), 4. <https://doi.org/10.3912/OJIN.Vol21No02Man04>
- 97) Woller, G. (n.d.). *Livelihood and Food Security Conceptual Framework*. United States Agency (USAID). International Development. https://www.marketlinks.org/sites/default/files/resource/files/LIFT%20ES%20Framework_8%2017%202011.pdf
- 98) World Commission on Environment and Development (n.d.). *Report of the World Commission on Environment and Development – Our Common Future*. <https://sustainabledevelopment.un.org/milestones/wced>
- 99) Yuan, F., and Marquardt, D.J. (2021 May). *Innovative Behavior*.
<https://www.oxfordbibliographies.com/display/document/obo-9780199846740/obo-9780199846740-0054.xml>
- 100) Zhang, Y., Geng, W., Shen, Y., Wang, Y., & Dai, Y.C. (2014). Edible Mushroom Cultivation for Food Security and Rural Development in China: Bio-Innovation, Technological Dissemination and Marketing. *Sustainability*, 6(5), 2961-2973. <https://doi.org/10.3390/su6052961>
- 101) Zion Market Research. (2018, August 31). *Mushroom Market To Witness Fabulous Growth In The With A CAGR Of 9.2%*. <https://www.zionmarketresearch.com/news/global-mushroom-market>
- 102) Zion Market Research. (2022, April 04). *Mushroom Market Size, Share, Trends, Growth Report and Forecast 2028*. <https://www.zionmarketresearch.com/report/mushroom-market>



There is an Open Access article, distributed under the term of the Creative Commons Attribution – Non Commercial 4.0 International (CC BY-NC 4.0) (<https://creativecommons.org/licenses/by-nc/4.0/>), which permits remixing, adapting and building upon the work for non-commercial use, provided the original work is properly cited.

Effect of Environmental Impact Assessment and Management on the Economic Growth of Developing Countries. Evidence from Nigeria. (1990-2023).



Elizabeth Ayuba Kwajaffa¹, Tamatuwa Kadiri Angulu², Taiwo Adewale Muritala³ (Ph.D),
Rahila Timothy Dantong⁴ (PhD) and ATAYI Abraham Vincent⁵ (Ph.D)

¹Operation Manager, China Harbour Engineering Company Nigeria Ltd,

²Department of Economics, Bingham University, Karu Nasarawa State, Nigeria.

³Department of Business Administration, Nile University of Nigeria,

⁴Department of Political Science, Plateau State University Bokkos. Nigeria

⁵Department of Economics, Plateau State University Bokkos. Nigeria.

ABSTRACT: Environmental Impact Assessment (EIA) and its management have become pivotal tools in balancing developmental goals with sustainable environmental practices, particularly in developing countries like Nigeria. This study examines the effects of EIA and environmental management on the economic growth of Nigeria from 1990 to 2023. The study used Autoregressive Distributive Lag (ARDL) technique. The result shows that a long run relationship was observed among the variables, foreign direct investment, trade openness and exchange rate were positive and insignificant in enhancing gross domestic product. While employment rate negatively and insignificantly enhanced gross domestic product growth. The study recommends among other things that government should create enabling business environment by simplifying regulatory procedures, reducing bureaucracy, and enhancing transparency. Government should also diversify export as this will encourage non-oil exports through incentives and support. Develop a comprehensive employment policy and invest in human capital development and Flexible exchange rate regime.

KEYWORDS: Environment, Impact Assessment, Economic Growth, ARDL and Nigeria.

1. INTRODUCTION

Environmental Impact Assessment (EIA) and its management thus have become an integral tool in ensuring that development occurs in a sustainable manner, considering the developing countries where every spurt of economic growth is usually accompanied by considerable environmental degradation. Arguably, this interplay between economic ambition and environmental stewardship may currently be best described in Nigeria, considering the nation's heavy reliance on its oil and gas sector. The legally required EIA process since 1992 seeks to reduce adverse environmental impacts that are brought forth by development projects through early consideration before the projects' approval. Such proactive approach also safeguards the ecosystems, while it contributes significantly to sustainable economic development. Research evidence has established that good practice in EIA can enhance investment potential by ensuring the application of environmental standards, thus building a stable and predictable regulatory environment. Further, when the process of EIA is an active representation of the community, the actual project is more likely to be responsive to the needs of its specific community, increasing social acceptance, and allowing its prospects for long-term viability. However, a few past reviews of EIAs in Nigeria have also been able to point out a number of challenges, including inefficient capacity, corruption, and general weakness in regulatory enforcement, which the latter impedes effectiveness in nature. This has questioned the actual development delivered by EIAs to economic progress, reflected through the works of Akinwumi (2020) and Ibrahim (2023).

Actually, EIAs need to be integrated into development planning in order to build the economic resilience of Nigeria. Indeed, some studies found that stringent EIA practices can stimulate foreign investments by showing commitment to environmental responsibility and regulatory compliance. In addition, effective EIA processes allow for involvement with the community where

Effect of Environmental Impact Assessment and Management on the Economic Growth of Developing Countries. Evidence from Nigeria. (1990-2023).

local populations are able to take part in the decision-making that often results in projects which are more socially and ecologically viable. In Nigeria, however, major constraints to the successful implementation of EIAs, such as inadequate technical capacity, political corruption, and weak enforcement of environmental laws and regulations impede the process from realizing its intended objectives.

This paper discusses in detail the elaborate relationship between EIA and economic growth within the context of developing countries, evidence from Nigeria, not only in terms of opportunities offered by EIAs for sustainable development but also barriers that prevent their impact. The current practices and challenges are analyzed in the light of providing a view to Nigeria on how to use EIAs as a tool for a more sustainable and prosperous future.

2. LITERATURE REVIEW

In fact, the Environmental Impact Assessment and management vis-à-vis economic growth relationship has been one in which a number of academic and policy debates have featured prominent within developing countries, such as Nigeria. This literature review synthesizes the current research on the effects of EIA and environmental management on economic growth of developing countries, emphasizing evidence from Nigeria.

The Role of EIA and management in Sustainable Development

It is seen as a tool for sustainable development in that it incorporates environmental aspects into the planning and decision-making apparatus for preparing projects. In the context of Nigeria, EIAs and management would reduce negative environmental impacts associated with rapid industrialization and urbanization. Scholars postulate that where EIA is effectively implemented, the outcomes of such projects would tend to become more feasible and sustainable; hence, justifying economic growth in the long term (Adelekan, 2018). For instance, EIAs have been applied in the oil and gas industries, one of the highest contributors to Nigeria's GDP, by implementing rules that reduce pollution and habitat destruction (Ogunleye & Alabi, 2019 2019).

Economic Benefits of Effective EIA and management Practices

Good EIA, therefore, protects the environment while concurrently contributing to economic development through the attraction of FDI. Investors are more often comfortable investing in those economies where there is a stringent environmental law, as such is perceived to provide stability and minimize risk (Okeowo, 2022). The oil and gas industry in Nigeria has been a beneficiary of high volumes of FDI. However, those projects without credible EIAs face some community opposition and regulatory difficulties that scare away investors (Nwankwo, 2021). On the other hand, projects that are accompanied by comprehensive EIAs are bound to increase the chances of success for a project and include community acceptance for overall economic development as well (Adeola et al., 2019).

EIAs promote environmental considerations within the economic planning process and are thus an enhancement to sustainable development. This will, for instance, include projects on road construction and building that can be conducted with a minimal negative impact on the environment if well assessed, thus encouraging growth in a sustainable manner. Attractiveness to Investment: A sound EIA framework will make Nigeria a better destination for foreign investors. Firms are increasingly interested in investing in those countries or regions which have stringent environmental policies, as these reduce the long-term risks associated with environmental liabilities (Ogunleye & Alabi, 2019). Community Engagement: EIAs often provide the local communities with a means to express their opinions on proposed development projects. The engagement contributes to better project outcomes and engenders community support, which is very necessary to ensure that development projects are successful (Nwankwo, 2021). Long-term Economic Resilience: EIAs are capable of facilitating identification, which is considered very important in lessening environmental hazards that might be associated with neglecting the environment, thereby ensuring long-term economic resiliency.

Challenges to EIA Implementation in Nigeria

Despite these accrued benefits, it would appear that a host of challenges neutralizes the effectiveness of EIAs in Nigeria. Corruption in regulatory bodies serves as a key hindrance where projects are approved against the presentation of inadequate environmental assessment reports. This act alone fosters corruption and leads to public distrust and damage to the environment which would later provoke economic instability. Thirdly, some inefficiency in technical capacity and training amongst EIA practitioners negates the expectation of conducting thorough assessments. The EIA process is also further complicated by a lack of awareness and involvement in local communities, often culminating in very unsatisfactory project outcomes that do not align with community needs.

Inadequate Capacity and Training: A fair number of practitioners lack relevant competencies and training in the performance of EIAs. Such inadequacy could result in poor assessments, which fail to identify significant environmental impacts. Corruption and

Effect of Environmental Impact Assessment and Management on the Economic Growth of Developing Countries. Evidence from Nigeria. (1990-2023).

Political Influence: Corruption may make the processes of EIA lack integrity through the approval of projects without proper assessment because of political connections or bribery. Limited Public Awareness: In the absence of proper knowledge about the EIA process among the public, community involvement might be minimal and hence ineffective in ensuring effective stakeholder engagement. Weak Regulatory Framework: Although the EIA Act exists, its implementation is still very weak. Many projects proceed without the necessary assessments; hence, this might increase environmental degradation.

Community Engagement and Its Impact on Economic Growth in Nigeria

Community involvement in the EIA and management process provides an extremely important influence on economic development. Literature evidence has shown that projects emanating from an EIA process involving the local communities stand the possibility of being better targeted to local needs and well accepted by the public. Community engagement through the EIA process gives only the appearance of legitimacy; rather, it serves to ensure that there is social stability, a necessary condition for creating an enabling environment for economic activities. Any project insensitive to these would result in its resistance and, consequently, delay and cost overrun, hence not being conducive to the creation of an enabling environment for economic development.

Successful EIA Practices in Nigeria

Niger Delta Development Projects

Some development projects in the Niger Delta have been able to incorporate EIAs into their planning. For instance, the Niger Delta Environmental Surveyor-NDES was to check environmental devastation in the region through the study of the effects of oil exploration and thereby made some recommendations on best practices for sustainability. It showed that broad-based assessments, while informing the reduction of environmental devastation, simultaneously promoted economic growth (Olofin, 2020).

Urbanization in Lagos

Lagos state has put into practice EIAs and management in major urban development projects such as the Eko Atlantic City. The EIA process within the project had great stakeholder consultations, coming up with an improved design for the said project that reduced adverse environmental impacts. This is one case where it can be proven that an efficient EIA leads to successful urban development with due consideration of environmental sustainability.

Comparative Perspectives from Other Developing Countries

More emphasis is therefore placed on the role of EIA and management in contributing to economic growth through a number of comparative studies from other developing countries. For example, studies in countries like India and Brazil have established that the well-implemented EIA processes ensure environmental upgrade and increase the confidence of the general public in government agencies. The point here is to illustrate that Nigeria actually can learn from global best practices of the implementation of EIA and management, especially on increased transparency and stakeholders' participation. In a nutshell, the literature cites that Environmental Impact Assessment and management plays an important role in promoting sustainable economic growth in Nigeria. Although effective EIAs can result in better environmental quality, improved investment, and community support, there are, among other areas, a number of challenges to be attended to for full potential to be realized. A strengthened EIA process through capacity building, transparency, and community involvement will certainly prepare Nigeria to cope with the attainment of sustainable development and economic resilience out of environmental challenges.

Empirical Review

The interaction between EIA and economic growth has, for years, been a focal point of empirical research, with a main focus on developing countries where the rapid advancement in economic development is straining environmental resources. This review synthesizes empirical studies exploring the effects of EIA and environmental management on economic growth of developing countries, with a particular focus on Nigeria.

EIA and management as a Tool of Sustainable Economic Growth

Various studies point out the importance of EIA and management as a way of achieving sustainable economic development in developing countries. For instance, Adeola et al. (2019) undertook a critical evaluation of the practice of EIA in Nigeria and concluded that projects subjected to proper EIA procedures often record higher levels of environmental performance and development in the local economies. In turn, their work concludes that good EIA practice can reduce the environmental risk from industrial projects, thereby contributing to continuing economic growth through natural resource sustainability.

Along the same line of reasoning, Ogunleye and Alabi (2019) establish how good EIA and good management implementation translates into higher FDI inflow in the oil and gas industry in Nigeria. From the work, it is clear that foreign investors would instead invest in areas that have more stringent environmental laws since such countries are considered less risky. This, therefore, forms

Effect of Environmental Impact Assessment and Management on the Economic Growth of Developing Countries. Evidence from Nigeria. (1990-2023).

the basis for the relationship that improved EIA practices lead to an enabling investment environment in the country, which in turn would spur economic growth and capital inflows.

Community Engagement and Economic Outcomes

Community engagement within an EIA process has been empirically tested. Nwankwo, (2021), conducted research on how the impacts of community participation in EIA projects were influencing their performance outcomes in Nigeria. It concluded that projects where the locals were engaged in the EIA processes showed better acceptance and success. This is a scenario that can only be achieved through community engagement, which will help in improving project designs through the use of local knowledge, minimizing unnecessary conflicts because of issues at hand that may be affecting the community and that have not been addressed, hence contributing to economic stability and growth. In support of the above findings, Ogunbanwo (2021) discusses urban development projects in Lagos. The research indeed showed that, when there was a request for community feedback and its incorporation into the EIA process, projects were likely to be completed on time and within budget. Efficiency here means economic benefits, and therefore inclusive practices become very important for sustainable development.

Challenges to EIA Implementation

Empirical evidence also reveals certain setbacks that run contrary to the known benefits of EIA and management in Nigeria. Akinwumi (2020) examined the challenges to EIA implementation and identified corruption as one of the major hindrances. The study established that bribery and political interference have often led to project approvals without due assessments, with resultant environmental degradations coupled with their negative impacts on economic growth. This again underlines the necessity of very vital and strong regulatory frameworks that ensure more accountability in making EIAs effective. Ibrahim (2023) assessed the technical capacity of EIA professionals in Nigeria, which he noted lacks proper training and expertise to conduct thorough assessments. The result showed that strengthened capacity-building processes are, therefore, necessary for quality EIAs and the attainment of sustainable economic growth.

EIA and Economic Performance

Studies consistently confirm that effective EIA contributes to economic performance by promoting sustainable development. For example, Adelekan's (2018) study examined the effectiveness of EIA and its related effect on economic growth in Nigeria. "Results show that projects with extensive EIAs recorded very low rates of environmental degradation, highly beneficial to the local economies by maintaining the natural resources required to generate livelihoods. It, therefore, concluded that an efficient EIA process is very vital in ensuring that economic growth does not come at the expense of environmental health. Along this line, the influence of EIA on investment decisions regarding Nigeria's construction sector was studied by Adewunmi (2020). The research found compliance with EIA regulations to reduce environmental risks and increased investor confidence. Projects that did apply EIA procedures tended to receive a higher percentage of both domestic and foreign investment. The implication of a well-conducted EIA would be that it acts as a promoter of economic growth.

The Role of Public Participation

Public participation is regarded as an increasingly major ingredient of the EIA and management process. Most empirical studies have found that local participation in EIAs generally generates a project that is more acceptable socially with better economic prospects. For example, Nwankwo (2021) emphasized that projects that integrated community needs into the EIA process generated less delay and conflict, with less hindrance to successful implementation, translating into improved economic returns. It showed that local wisdom would always provide better information for decision-making that would make the projects responsive to the needs of the communities. Ogunbanwo (2021) supported these findings when he looked into urban development projects in Lagos, finding that stakeholder engagement in EIA processes contributed to better project outcomes. Community engagement increased project success rates and ensured that people took ownership of projects, thus contributing toward ensuring economic growth was sustained.

Impact of EIA and management on Sectoral Development

The nuanced effects of EIA and management on economic growth could be better reflected in sector-specific studies. Such a recent analysis regarding the agricultural sector has been done by Ogundipe et al. (2022), where it was found that EIAs contributed to land use in a sustainable manner which resulted in increased agricultural productivity. The study showed that incorporating environmental assessment into agricultural planning has managed so far not only to reduce adverse environmental impacts but also to enhance food security and resilience in rural communities' economies.

Comparative Evidence from Other Developing Countries

The comparisons done with other developing countries provide an overview of the potential that EIA and management possesses to bring about changes in economic development. Overall, findings from countries like Brazil and India indicate that good EIA and management frameworks facilitate better environmental governance and generally increase public confidence in government

Effect of Environmental Impact Assessment and Management on the Economic Growth of Developing Countries. Evidence from Nigeria. (1990-2023).

institutions. These findings consequently have implications for the fact that Nigeria could borrow from these countries in terms of best practices, especially relating to aspects of regulatory transparency and community engagement strategies. Empirical evidence from other developing countries also sheds light on the potential influence of EIA and good management on economic growth. For instance, studies in India and Brazil indicate that adequately organized EIA processes may lead to better environmental management, thus offering enhanced investment prospects for projects. The above findings also suggest that through imported lessons from global best practices, Nigeria can refine its EIA framework in order to reap the maximum economic benefits.

Put differently, it is relevant to underline that the empirical literature has indicated EIA and proper management as a tool that can facilitate attainment of sustainable economic growth in Nigeria. Good practices in EIA have the capability to create better environmental performances, investment, and improve community acceptance in addition to other projects in developing countries. Nevertheless, challenges like corruption and lack of adequate technical capacity should be surmounted if developing countries are to maximize full potential benefits accrued from EIAs. Increasing training, community involvement, and reforming the mechanisms for EIA practices will be vital in reaching a goal of sustainable development and economic resilience for Nigeria.

Theoretical Review

The theoretical framework of EIA and management with regard to economic growth, most especially in developing nations such as Nigeria, encompasses various models and concepts that cumulatively aimed at linking environmental management to economic development. This review reveals the critical theoretical perspectives informing the relationship between EIA, management and economic growth, focusing on insights relevant to the Nigerian economy.

Theory of Sustainable Development

The concept at the heart of the discussion on EIA and management is sustainable development. This is a model that makes striking balancing between economic growth and environmental protection. The Brundtland Commission defined it in the following words: "Development that meets the needs of the present without compromising the ability of future generations to meet their own needs" (Brundtland Commission, 1987). This framework now makes it important that there are EIAs, since this would ensure that the pursuit of economic activities will be done in a manner that does not deplete natural resources or degrade environmental quality. Application of the principles of sustainable development through robust EIA practice, therefore, is necessary in Nigeria, where economic activities, especially those in the oil and gas sector, are usually very prone to environmental hazards.

The Institutional Theory of EIA

Institutional theory provides a framework in which the EIA and management processes are shaped with regard to regulatory frameworks, organizational structures, and stakeholder interactions. According to North, institutions-the rule, norm, and organization guiding the interactions within a society-play an important role in determining economic output. Considering the case of Nigeria, for example, institutional factors affect how well EIA processes work in terms of the quality of governance, whether regulations have been enforced, and the level of participation by the public. Indeed, good institutional frameworks have been shown to spur the quality of EIAs, which in turn would lead to better environmental management and then economic growth that is more sustainable.

Public Participation Theory

Public participation is considered a cardinal principle underlying the EIA process from the standpoint of democratic theory and social justice. Arnstein's (1969) Ladder of Citizen Participation recognized a number of levels of involvement on the part of the public, ranging from manipulation to various forms of citizen control. In many instances, effective EIA practices in Nigeria need meaningful engagement with the affected community for better project designs that may be socially acceptable. Communities' involvement in the process will make EIAs more responsive to the concerns of the locals. Therefore, projects are likely to be economically viable and ecologically sustainable. Such participation by a community also supports a number of theories related to social capital, which say that involvement of a community can result in improving ways through which the collectives make decisions and can promote trust (Putnam, 1993).

Economic Theories of Environmental Management

The relationship between, environmental management and economic growth can also be brought under scrutiny using various economic theories, including the EKC hypothesis. The EKC hypothesis assumes that, with the development of an economy, environmental degradation first increases up to a certain income level before starting to decline. This theory indicates that an efficient EIA process may enable a developing nation like Nigeria to transition to a sustainable practice before it gets too late and the degradation of the environment gets too high. Through appropriate EIAs, early identification and mitigation of impacts on the environment can be made possible, possibly altering the path of economic growth in Nigeria towards sustainability (Ogunleye & Alabi 2019).

Effect of Environmental Impact Assessment and Management on the Economic Growth of Developing Countries. Evidence from Nigeria. (1990-2023).

The Role of Institutional Economics

Institutional economics further explains the connection between EIA and economic growth in relation to how institutional arrangements affect environmental policies and practices. For example, Coase's Theorem states that if property rights are well-defined and transaction costs low, then parties can bargain effectively to resolve the problem of externalities. The enhanced EIA process may provide detailed information regarding property rights and responsibility. It would, in turn, lead to more efficient negotiations among stakeholders: community, government, and investor, hence leading to better environmental management along with better economic outcomes.

The theoretical standpoints shared in the paper paint the multi-dimensional relationship existing between EIA and economic growth regarding developing countries such as Nigeria. The theory of sustainable development calls for a common interface between environmental thought and economic planning, while institutional theory stresses the need for governance and regulatory mechanism. Public participation theory supports the involvement of community involvement in EIA, while economic theories provide lessons on how to manage development and environmental sustainability trade-offs. These can thus be used to develop theoretical insights into how EIAs might be used as a tool for policymakers to help realize sustainable economic growth in Nigeria.

3. METHODOLOGY

This is a mixed-methods study that attempts to evaluate the impact that environmental impact assessment and management have on the economic growth of developing countries with evidence drawn from Nigeria. The methodology contains both qualitative and quantitative components, which helps in comprehensively understanding the dynamics at play in this study. The quantitative part of this research design follows a descriptive correlational analysis design that shall enable testing the relationships of EIA and good management practices to measurable economic indicators such as Gross Domestic Product (GDP), foreign direct investment, trade openness, exchange rate and employment rates. Quantitative data come from several key databases and governmental reports. Data sources, in this respect, are from: National Bureau of Statistics, Federal Ministry of Environment, World Bank and United Nations Development Programme (UNDP). Quantitative analysis covers a period from 1990 to 2023, allowing the observation of trends and correlations between EIA practices and economic growth metrics.

Model Specification

$$GDP = \beta_0 + \beta_1 TO + \beta_2 FDI + \beta_3 Employment + \beta_4 EXCR + \epsilon$$

Where:

Economic Growth refers to GDP growth.

TO refers to Trade Openness.

EXCR refers to Exchange Rate

FDI captures foreign direct investment inflows.

EMPL represents employment rates in relevant sectors.

ϵ is the error term.

Limitations

This study realizes probable limitations, like the issue of availability and reliability of data, especially relating to implementation level of EIA and resultant economic impacts. Focusing on a single country, which is Nigeria, might have limited generalizability to other developing countries, though comparative insights will be drawn from the literature.

4. RESULTS AND INTERPRETATION

Unit Root Test

In environmental impact assessment analysis, the unit root test is used to test time series data stationarity because most economic variables are dependent. The Stationarity properties of the variables included in the models were tested using the Augmented Dickey Fuller and the results are presented on Table 1.

Table 1: Result of Unit Root of Variables

Variable	ADF order of integration	0.05 ADF critical values	ADF test Statistic
GDP	I(0)	-3.7364	-2.9540
FDI	I(1)	-6.9805	-2.9471
TO	I(1)	-5.4450	-2.9604

Effect of Environmental Impact Assessment and Management on the Economic Growth of Developing Countries. Evidence from Nigeria. (1990-2023).

EMPL	I(1)	-4.5801	-2.9639
EXCR	I(1)	-5.3152	-2.9604

Source: Researcher's Computation E-Views, 10.0

Above table shows the order of integration-stationarity for the study series. In the ADF test all series except GDP were stationary at level. FDI, TO, EMPL and EXCR attained stationarity at first difference after undergoing further treatment. So all series were stationary at level and first differencing. Since our series was stationary at level, 1(0), and first differencing 1(1), we should study the long-term link between environmental impact assessment on the growth of Nigeria's economy. The researcher thereby used ARDL long and short run tests to verify the result.

ARDL Bounds Test

Bounds test was applied to investigate the long-run relationship between environmental impact assessment and economic growth. This is because the bounds test allows a mixture of I(0) and I(1) variables as regressors, that is, the order of integration of appropriate variables may not necessarily be the same. The following hypothesis is formulated to determine the long-run relationship between the variables

$H_0 = \beta_1 = 0$ (no long-run relationship)

Against the alternative hypothesis

$H_0 \neq \beta_1 \neq 0$ (a long-run relationship exists)

Decision Rule

If the computed F-ststistic is smaller than the lower bound value, then the null hypothesis is not rejected and it concludes that there is no long-run relationship. Conversely, if the computed F-statistic is greater than the upper bound value, then there is a long-run level relationship. On the other hand, if the computed F-statistic falls between the lower and upper bound values, then the results are inconclusive.

Table 2 Results of ARDL/Bounds Test

Test Statistic	Value	k	Significance	Critical Value Bounds	
				I(0) Bound Lower	I(1) Bound Upper
F-statistic	3.505641	4	10%	2.20	3.09
			5%	2.56	3.49
			2.5%	2.88	3.87
			1%	3.29	4.37

Source: Researcher's Computation E-Views, 10.0

The F-statistic value of 3.505641 is higher than the 5% critical values at both I(0) and I(1). This means that we reject the null hypothesis and come to the conclusion that the variables are related over the long term. In conclusion, there is a long-term link between Nigeria's economy and the environmental impact assessment.

ARDL Estimation

Table 3: ARDL Cointegrating and Long Run Form

Variable	Coefficient	Std. Error	t-Statistic	Prob.
FDI	0.513746	1.287935	0.398892	0.6932
TO	0.149118	0.257032	0.580152	0.5668
EMPL	-1.305470	1.220163	-1.069914	0.2945
EXCR	2.579522	4.890870	0.527416	0.6024
C	5.625595	16.39670	0.343093	0.7343

$EC = GDP - (0.5137*FDI + 0.1491*TO - 1.3055*EMPL + 2.5795*EXCR + 5.6256)$

Source: Researcher's Computation E-Views, 10.0

Effect of Environmental Impact Assessment and Management on the Economic Growth of Developing Countries. Evidence from Nigeria. (1990-2023).

Table 3 presents the long-run estimate of the relationship between economic growth and environmental impact assessment proxied with foreign direct investment, while trade openness, employment rate in the relevant sectors, and exchange rate are employed as control variables in the model.

The result clearly indicated from the model that FDI is an insignificant and positive factor in explaining changes in economic growth—a fact which is at variance with the endogenous growth theory, which posits that FDI is one of the most important drivers of economic growth. The ratio of FDI is positive but insignificant in explaining changes in economic growth. That implies that with a 1% increase in FDI, the gross domestic product will approximately be 51.37%, which in turn enhances economic growth. The outcome is consistent with Shehu and Bashir 2023 and Saibu and Mesagan 2016. This indicates that the ratio of FDI alone does not exogenously impact growth.

However, the trade openness is found to be positive and insignificant in the study and on the average 1% increase in trade openness while keeping other explanatory variables constant boosts the GDP by 14.91%. This is also expected as Nigeria is an import dependent country vis-à-vis its export of crude oil in commercial quantity.

Its coefficient, the employment rate, is negative and insignificant in explaining changes in economic growth. That is not unexpected since economic theory would dictate that unemployment will detract from economic growth since it erodes purchasing power. This is because the labour market in Nigeria is of low productivity, a large percentage of Nigeria's labour force operates within the informal sector, and too large a number of workers lack useful skills for making meaningful contribution to GDP, while the economy is not diversified, leading to limited opportunities for employment in high-productivity sectors.

The result regarding the exchange rate shows a long-run coefficient value of 2.5795 with corresponding p-values of 0.6024 respectively. This suggests that the exchange rate is statistically insignificantly integrated with economic growth proxied by GDP in the long run. This is an indication that with a proportional increase in the exchange rate, a corresponding proportional increase in Gross Domestic Product occurred but was insignificantly achieved in the long run. It is rooted in the fact that this persistent dominance of the foreign currencies, such as the USD (\$), British Pound sterling (£), and other hard currencies over and above the local currency, is a source of concern and may be devastating to the economy at large. It is deduced that a relative loss of value of the local currency to foreign currency implies a volatile foreign exchange market characterized by persistence volatility in the foreign exchange rate. Consequently, the exchange rate shocks positively and insignificantly co-integrate gross domestic product in the long run. This is ascertained from the p-value which is not significant at 5% significance level. The negative contribution of exchange rate on the GDP of the Nigeria economy goes in line with the works of Andrew and Onerhime (2024), kolapo, Oke, and Olaniyan (2018). Exchange rate is which is expected to influence the level of gross domestic product in Nigeria. Thus, exchange rate whether favourable or unfavourable, might impact very strongly on gross domestic product in Nigeria.

Heteroskedasticity Test

This is also called the residual analysis. It is compulsory to check for the presence of heteroscedasticity in order to check if the model built can explain some variations in the response variable which eventually shows up in the residual. If there is a problem of heteroskedasticity, there is high possibility of the model been unstable and inefficient to predict the phenomenon. From the result in Table 4; the p-value of the test is greater than 5% significant level, which implies that the model specified is free of heteroskedasticity problem.

Table 4

Heteroskedasticity Test: Breusch-Pagan-Godfrey			
F-statistic	1.023448	Prob. F(5,26)	0.4244
Obs*R-squared	5.262411	Prob. Chi-Square(5)	0.3847
Scaled explained SS	10.64489	Prob. Chi-Square(5)	0.0589

Source: Researcher's Computation E-Views, 10.0

Multicollinearity Test – Variance Inflation Factor (VIF)

As previously stated, this test is performed to ensure that the variables are not multicollinear (in line with the assumption of the OLS estimation technique).

Table 5: Variance Inflation Factors

Variable	Coefficient Variance	Uncentered VIF	Centered VIF

Effect of Environmental Impact Assessment and Management on the Economic Growth of Developing Countries. Evidence from Nigeria. (1990-2023).

GDP(-1)	0.028786	2.938053	1.339319
FDI	0.925815	6.785177	1.972167
TO	0.036782	304.3908	5.415971
EMPL	0.769228	315.9615	3.493805
EXCR	12.27174	151.3015	7.938271
C	141.6994	421.3807	NA

Source: Researcher’s Computation E-Views, 10.0

Generally, the result from the table shows that problem of multi-collinearity is not anticipated. Though, a further test was carried out to ascertain this condition. From the above table, the variance inflation factor show that Uncentered VIF values are greater than the Centre VIF values. This shows the absence of multi-collinearity problem.

Stability Tests

For testing the stability of the long-run coefficients along with the short-run dynamics, the cumulative sum (CUSUM) and cumulative sum of square applied.

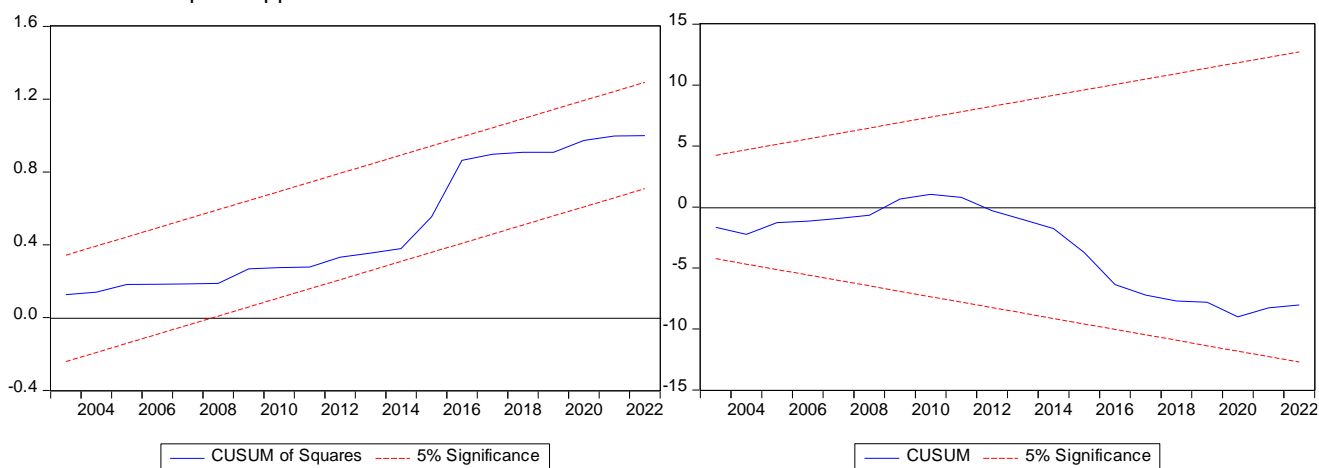

Fig. 1: Cumulative Sum (CUSUM)

Source: Researcher’s Computation E-Views, 10.0

A graphical illustration of CUSUM and CUSUMSQR is exposed in Figures 1 above. The plot of the CUSUM and CUSUMSQR is within the boundaries, and hence these statistics prove the stability of the long-run coefficients of the regressors that have an effect on gross domestic product (GDP) in Nigeria within the period.

5. CONCLUSION AND RECOMMENDATIONS

Integrating EIAs and management into Nigeria's development framework will provide critical opportunities for the consolidation of sustainable economic growth. While very important in impact, the benefits come hand in hand with challenges such as capacity building, corruption, and regulatory enforcement. Strengthening EIA practices will, therefore, help Nigeria align economic ambitions with environmental sustainability in pursuit of a resilient and equitable future. Recent literature on foreign direct investment stipulates that FDI's positive impact on economic growth is with regard to the prevailing local conditions in an economy as well as its absorptive capacity. The study therefore recommends the provision of improvement to business environment. This is because it will ease regulatory procedures by reducing bureaucratic barriers to boost transparency. Diversification of the export base is also recommended and that will encourage non-oil exports through the use of incentives and support. Developing a broad employment policy is worth consideration, along with investing in human capital development. The flexible exchange rate regime should be supplemented with appropriate policies that could save the output growth of the economy in the long run.

REFERENCES

1) Adelekan, I. O. (2018). Environmental Degradation and Economic Growth in Nigeria. *Environmental Science & Policy*, 86, 71-81.

Effect of Environmental Impact Assessment and Management on the Economic Growth of Developing Countries. Evidence from Nigeria. (1990-2023).

- 2) Adeola, A. O., Ogundipe, A. A., & Okeowo, O. (2019). The Role of Environmental Impact Assessment in Sustainable Development: Evidence from Nigeria. *Sustainability*, 11(3), 620.
- 3) Adewunmi, A. A. (2020). Assessing the Impact of Environmental Impact Assessments on Sustainable Development in Nigeria. *Journal of Environmental Management*, 250, 109501.
- 4) Arnstein, S. R. (1969). A Ladder of Citizen Participation. *Journal of the American Planning Association*, 35(4), 216-224.
- 5) Coase, R. H. (1960). The Problem of Social Cost. *Journal of Law and Economics*, 3, 1-44.
- 6) Fischer, T., Schlegel, A., & Weidema, B. (2020). Environmental Impact Assessment in Developing Countries: Lessons from Comparative Studies. *Environmental Impact Assessment Review*, 80, 106327.
- 7) Glasson, J., Therivel, R., & Chadwick, A. (2012). *Introduction to Environmental Impact Assessment*. Routledge.
- 8) Grossman, G. M., & Krueger, A. B. (1995). Economic Growth and the Environment. *Quarterly Journal of Economics*, 110(2), 353-377.
- 9) Ibrahim, M. (2023). Strengthening Environmental Regulations in Nigeria: The Role of the EIA Process. *International Journal of Environmental Policy and Decision Making*, 7(2), 95-107.
- 10) National Bureau of Statistics (NBS), Nigeria. (2023). *Annual Economic Report*. Retrieved from [NBS website].
- 11) Nwankwo, E. (2021). Community Participation in Environmental Impact Assessment: A Case Study in Nigeria. *Journal of Environmental Policy & Planning*, 23(2), 123-135.
- 12) Ogunbanwo, O. (2021). Urban Development and Environmental Impact Assessment in Lagos: A Case Study of Eko Atlantic City. *Nigerian Journal of Environmental Management*, 10(1), 34-47.
- 13) Ogundipe, A. A., & Adeola, A. O. (2022). The Role of EIA in Agricultural Development: A Case Study from Nigeria. *Sustainable Agriculture Reviews*, 48, 121-137.
- 14) Ogunleye, I. O., & Alabi, A. (2019). Foreign Direct Investment and Environmental Regulations in Nigeria: The Role of Environmental Impact Assessment. *Journal of African Business*, 20(1), 45-61.
- 15) Okeowo, O. (2022). Corruption and the EIA Process in Nigeria: Implications for Sustainable Development. *Journal of Environmental Law*, 34(1), 45-67.
- 16) Olofin, E. (2020). The Niger Delta Environmental Survey: A Model for Sustainable Development in Oil-Producing Regions. *Journal of Oil and Gas Law and Policy*, 7(3), 215-233.
- 17) Olowofela, A., Akintayo, I., & Abubakar, A. (2021). Public Awareness and Participation in Environmental Impact Assessment in Nigeria: A Case Study. *Environmental Management*, 67(4), 580-590.
- 18) Putnam, R. D. (1993). *Making Democracy Work: Civic Traditions in Modern Italy*. Princeton University Press.
- 19) United Nations Development Programme (UNDP). (2021). *Human Development Reports*. Retrieved from [UNDP website].
- 20) World Bank. (2022). *World Development Indicators*. Retrieved from [World Bank website].



There is an Open Access article, distributed under the term of the Creative Commons Attribution – Non Commercial 4.0 International (CC BY-NC 4.0) (<https://creativecommons.org/licenses/by-nc/4.0/>), which permits remixing, adapting and building upon the work for non-commercial use, provided the original work is properly cited.

WHY PUBLISH WITH IJMRA?

1. WE PROVIDE FULL OPEN ACCESS.
2. DOI OF EACH PUBLISHED ARTICLE.
3. THE ARTICLE WILL BE UPLOADED AFTER PUBLICATION IN THE FOLLOWING INDEXING SERVICES: GOOGLE SCHOLAR, INDEX COPERNICUS, DRJI, CITE FACTOR, ISI, EURO PUB, ACADEMIA, ZENODO, SCRIBD ETC. (MANY MORE)
4. FAST RESPONSE, PEER REVIEW, AND FAST PUBLICATION.
5. GLOBAL INTERNATIONAL KNOWLEDGE SHARING.
6. A DIGITALLY SIGNED E-CERTIFICATE WILL BE PROVIDED TO THE AUTHOR FOR A PUBLISHED ARTICLE.
7. YEARLY SUBSCRIPTION



Feel free to contact us, if you need any queries to be answered

info@ijmra.in
editor@ijmra.in
board@ijmra.in

